



ISO 9001:2015 CERTIFIED
**BROOKFIELD
AMETEK®**

Product Catalog

VISCOMETERS & RHEOMETERS

TEXTURE ANALYZERS

POWDER FLOW TESTERS

Index

Why Measure Viscosity.....	6
Laboratory: with software descriptions	
DV3T & DV3T Extra Rheometer.....	8-9
DV2T & DV2T Extra Viscometer.....	10-11
DV1 Viscometer.....	12
Software for DV3T, DV2T & DV1.....	14
DVE Viscometer.....	15
Dial Reading Viscometer.....	16
KU-3 Viscometer.....	17
Falling Ball Viscometer.....	18
Gel Timer.....	19
Cone & Plate, Wells/Brookfield.....	20
CAP 2000+ and CAP 1000+.....	22
RST Rheometers.....	24
RST-CC & RST-SST Option Guide.....	28
PVS Rheometer.....	30
BF35 Viscometer.....	32
Temperature Control	
Water Baths.....	33
Thermosel.....	36
Accessories	
Small Sample Adapter.....	38
Enhanced UL Adapter.....	40
Helipath Stand.....	42
Vane Spindles.....	43
Adapters (DIN, Spiral).....	44
Spindles, Cups, Chambers.....	45
Quick Connect.....	49
Instrument Stands.....	50
Ball Bearing & EZ-Lock Options.....	50
Protective Covers & Decals.....	51
Dymo Label Writer.....	51
Viscosity Standards.....	52
Texture Analyzer	
What is Texture Analysis?.....	56
CT3 Texture Analyzer.....	58
CT3 Accessories.....	60-67
Powder Flow Tester	
What is Powder Flow Testing?.....	70
PFT Powder Flow Tester.....	72
AMETEK Brookfield Systems	
Adhesives, Chocolate.....	74
Paints/Coatings/Ink.....	74
Asphalt, Personal Care Products.....	75
Electronics Paste.....	75
Pharmaceutical, Petroleum.....	76
Sauces & Dressings.....	76
Construction Materials.....	77
Dairy Products.....	77
Process	
Why Process?.....	80
FAST-100 Viscometer Series.....	82
TT-100 Viscometer Series.....	83
Viscosel Series (VTE), PV-100.....	83
General	
Testing & Consulting Services.....	84
Calibration and Certification.....	85
IQ, OQ, PQ.....	85
Education.....	86
Help & Resources.....	87
Glossary.....	88
Dealers.....	89

AMETEK Brookfield salutes our customers around the world

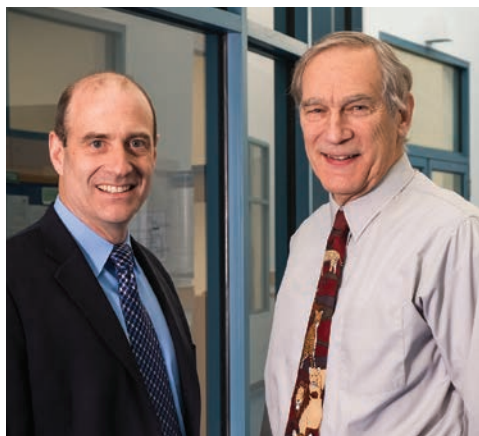

Joseph Plante
Division VP / Business Unit Manager
AMETEK ISC

David Brookfield
Chief Technology Officer

Joining AMETEK has worked well for Brookfield and our global customer base. Operations in all geographies (Americas, Europe, Middle East, and Asia) have strengthened with many new customers using Brookfield products to measure viscosity, texture and powder flow. Customer surveys have provided helpful input on important new requirements for instrument features, software enhancements, and data management. Our newly redesigned website at www.brookfieldengineering.com will soon be translated into several languages.

Joe Plante has joined Brookfield as our new Division VP and Business Unit Manager. He brings a wealth of experience in growth management complemented by a steady focus on customer satisfaction. Industry continues to request new ways to automate instrument operation, capture test data remotely, and alert lab and process technicians when problems arise. Joe's background providing timely response to diverse customer needs ensures that Brookfield will address the many challenges that you give us.

David Brookfield continues to evolve his vision for future test instruments by investigating new sensing technologies that can revolutionize flow measurement. His technical background in physics and engineering provides the right fundamentals for envisioning new instrumental methods that have application in both lab and process environments.

AMETEK Brookfield continues to welcome customers seeking our partnership in solving flow measurement problems that may not appear to have an immediate solution. By working together, we find ways to design a practical test method, drawing as much as possible on proven instrumentation. Take a look at the next page for evidence of this collaboration.

We welcome our customers to bring us your challenges. Working with you is what drives progress in our respective businesses. We value your partnership.



Introducing the **NEW KU3 Viscometer**

AFFORDABLE AND EASY TO USE

The KU-3 is widely used in the paints and coatings industry to measure viscosity in accordance with ASTM D562. New features include a magnetic spindle coupling for rapid attachment and quick release of Krebs and paste spindles. The user interface has been updated with touchpad control and bright LED display of viscosity in Krebs units, grams (weight), and centipoise. RoHS compliance satisfies new industry requirements that went into effect in 2017. See page 17 for details.

More Texture Applications Using New and Improved Fixtures

The heavy duty Kramer Shear Cell has fewer blades; sharpened ends provide increased cutting capability for many different food samples. The vertically-oriented Tube Extrusion fixture is designed for continuous squeezing action on cosmetic and pharmaceutical creams and ointments. The rotary index table accommodates rapid testing of multiple samples for the adhesive tack test. See pages 60-64 for several other new test fixtures.



TA-KSC-002
Kramer Shear Cell



TA-TEF
Tube Extrusion Fixture

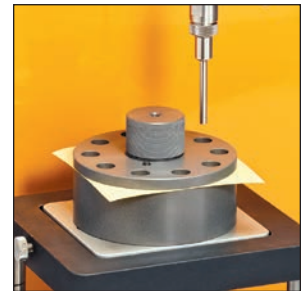

TA-RIF
Rotary Indexing Fixture

Introducing the **NEW Gel Timer**

Used for resins, gel coats and potting compounds, the Gel Timer consists of a DV2TRV Viscometer equipped with a special magnetic coupling and glass rod assembly which rotates in a test material at 1 rpm. Gel time, % torque and viscosity are all measured simultaneously. See page 19 for details.





viscose rheologie

eters
eters



Why measure viscosity?

The ability to gather data on a material's viscosity behavior gives manufacturers an important "product dimension." Knowledge of a material's rheological characteristics is valuable in predicting its pourability, its performance in a dipping or coating operation, or the ease with which it may be handled, processed, or used. The interrelation between rheology and other product dimensions often makes the measurement of viscosity the most sensitive or convenient way of detecting changes in color, density, stability, solids content, and molecular weight.

Why Choose AMETEK Brookfield?

Ease of use, flexibility, reliable performance and quality of service have made AMETEK Brookfield Viscometers favorites all over the world. All AMETEK Brookfield Viscometers are accurate within $\pm 1.0\%$ of the range in use and have a reproducibility within $\pm 0.2\%$. Test results can be duplicated anywhere in the world when the same model instrument is used.

Price

Choices for Instrumentation

This chart shows the AMETEK Brookfield family of Laboratory Viscometers and Rheometers at a glance. This will help to give you a general idea of what is available before making a decision. The horizontal axis indicates performance capability and features while the vertical axis addresses price level.

Need to measure viscosity in-line?
AMETEK Brookfield also offers a complete line of process viscometers. (p78)



Dial Reading
• Torque



DVE
• Calculates Viscosity
• Torque



DV1 Cone/Plate
• Small Sample Size
• Defined Shear Rate



DV1
• Optional Temp Probe
• Calculates Viscosity
• Torque



DV2T Cone/Plate
• Small Sample Size
• Defined Shear Rate



DV2T
• Touch Screen Interface
• Temp Probe
• Data / User Security
• PC Control
• Calculates Viscosity
• Torque



DV3T Cone/Plate
• Small Sample Size
• Defined Shear Rate



DV3T
• Touch Screen Interface
• Real Time Graphing
• Temp Probe
• Data / User Security
• PC Control
• Calculates Viscosity
• Torque
• Yield Stress



CAP 2000+ Cone/Plate
• Broad Shear Rate Range
• Peltier Plate Temp Control
• RS232 (PC control)



RST Cone/Plate
• Peltier Plate



RST Coaxial Cylinder
• Controlled Stress & Rate
• Yield Stress
• Stand Alone Programmable
• Temp Probe
• USB & RS232
• Calculates Viscosity
• Torque



PVS Rheometer
• Pressurized Sample Chamber
• Controlled Rate
• Temp Probe
• RS232/USB
• Calculates Viscosity
• Torque

Performance

SPECIAL PURPOSE INSTRUMENTS



KU-3 Viscometer
• KREBS Viscosity
• Required for Paint and Coatings



CAP 1000+ Cone/Plate
• Single Shear Rate
• Required for Paints and Coatings



RST Soft Solids Tester
• Yield Stress
• Creep
• Recovery



Falling Ball Viscometer
• Viscosity
• Used for QC & Academic Institutions



BF35 Viscometer
• Viscosity
• Used for Oil Drilling & Fracturing Fluids

AMETEK Brookfield also offers several special purpose instruments which are used to perform a specific type of test or are used to evaluate certain types of materials.

Questions to Consider

1. What is the viscosity range of your material: Low, medium, high?
2. What rotational speeds or shear rates are important?
3. How much sample is available for testing?
4. Is temperature measurement/control necessary?
5. Do you need to record the viscosity data?

The Selection Method

The Model Selection Table (shown at right) shows detailed information on standard AMETEK Brookfield Viscometers/Rheometers, including the Dial Reading, DVE, DV1, DV2T, and DV3T. The Applications Table (shown at lower right) shows information on typical applications of the standard AMETEK Brookfield viscosity ranges. There may be industry or supplier/vendor specifications that you need to duplicate. Before making a final selection, we suggest that you confer with people in your industry to find out which AMETEK Brookfield Viscometer they are using so that your data can be correlated. More application details may be found throughout this catalog for other AMETEK Brookfield instruments on the following pages:

CAP 1000+/2000+ Viscometers (p22-23) *KU-3 Viscometer* (p17)
PVS Rheometer (p30-31) *CT3 Texture Analyzer* (p54-67)
RST Touch Series Rheometers (p24-29)

In addition, you may wish to call us and discuss your application or refer to our extensive library of technical papers which covers a complete spectrum of applications. We can also test your materials at AMETEK Brookfield to recommend the instrument most suitable for your application.

Spindles

Standard AMETEK Brookfield Viscometers/Rheometers are supplied with a standard spindle set constructed of stainless steel (#302). Additional spindle options are available in #316 stainless steel or with Teflon coating for increased corrosion resistance. Other spindles and accessories are also available. (p45-48)

Cylindrical Spindles

Cylindrical spindles are particularly valuable when measuring non-Newtonian fluids and are applicable to any AMETEK Brookfield Viscometer model with the use of appropriate range tables. Cylindrical spindles may be substituted for standard spindles upon request.



Need additional assistance? Our website, www.brookfieldengineering.com, contains additional information on the measurement selection process as well as detailed application notes.

Model Selection Table AMETEK Brookfield Standard Viscometers/Rheometers

**MODEL	Min. cP/(mPa·s) VISCOSITY RANGE	Max. cP/(mPa·s) VISCOSITY RANGE	NUMBER OF SPEEDS	# of Spindles Supplied
LOW VISCOSITY				
LVT	1*	2 M	8	4
DVELV	1*	2 M	18	4
DV1LV	1*	2 M	18	4
DV2TLV	1*	6 M	200	4
DV3TLV	1*	6 M	2600	4
MEDIUM VISCOSITY				
RVT	100	8 M	10	6
DVERV	100	13 M	18	6
DV1RV	100	13 M	18	6
DV2TRV	100	40 M	200	6
DV3TRV	100	40 M	2600	6
HIGH VISCOSITY				
HAT	200	16 M	10	6
DVEHA	200	26 M	18	6
DV1HA	200	26 M	18	6
DV2THA	200	80 M	200	6
DV3THA	200	80 M	2600	6
HBT	800	64 M	10	6
DVEHB	800	104 M	18	6
DV1HB	800	104 M	18	6
DV2THB	800	320 M	200	6
DV3THB	800	320 M	2600	6

** Standard torque range values M = 1 millin

* Minimum ranges can be extended to as low as 1 cP with the use of accessories

Applications Table

Consider application and viscosity range when selecting model (LV, RV, HA, HB)

LV SERIES – LOW VISCOSITY

Adhesives (solvent base)	Juices	Photo Resist
Biological Fluids	Latex	Polymer Solutions
Chemicals	Milk	Rubber Solutions
Dairy Products	Oils	Solvents
Hot Waxes	Paints and Coatings	
Inks	Pharmaceuticals	

RV SERIES – MEDIUM VISCOSITY

Adhesives (hot melt)	Food Products	Paper Pulp
Asphalt (SHRP)	Gums	Plastisols
Ceramic Slurries	Inks (screen printing)	Starches
Cosmetics	Organisols	Surface Coatings
Creams	Paints	Toothpaste
Dairy Products	Paper Coatings	Varnish

HA/HB SERIES – HIGH VISCOSITY

Asphalt	Pastes
Caulking Compounds	Peanut Butter
Chocolate	Putty
Epoxies	Roofing Compounds
Gels	Sealants
Inks (ballpoint, offset, lithographic)	Sheet Molding Compound
Molasses	Tars

DV3T™ Rheometer

the all-in-one tool for measuring viscosity and yield stress

7-inch Full Color Touch Screen Display

- New User Interface
- Enhanced Controls
- Real Time Graphing
- Supports Multiple Languages

Displayed Info:

- Viscosity (cP or mPa•s)
- Temperature (°C or °F)
- Shear Rate/Stress
- % Torque
- Speed/Spindle
- Step Program Status
- Math Model Calculations

Built-in math models for data analysis in stand-alone mode. E.g. Casson, Bingham, Power Law, Thix Index

Enhanced Security

- Customizable User Access
- Date and Time Stamp File
- Password Access
- Portable Log-in Settings

Built-In Options

- Math Modeling
- Temperature Control
- Yield Tests
- Programmable QC Limits/Alarms

Analyze characteristics such as yield stress, flow curves (mixing, pumping, spraying), leveling and recovery

USB PC Interface provides optional computer control and automatic data collection capability

Convenient Bubble Level

Internal Data Storage: 150 MB



Integrated Temperature Control with connection to AMETEK Brookfield TC series Baths and AP/SD Controllers or AMETEK Brookfield Thermosel System.

Stand-alone programming or download custom test programs with PG Flash Software.

Built-in RTD Temperature Probe

Accuracy: ±1.0% of range

- Displayed with test data

Repeatability: ±0.2%

What's Included?

- Instrument
 - 6 spindles (RV/HA/HB) (p45) or 4 spindles (LV) (p45)
 - PG Flash Software ▶
 - RTD Temperature Probe
 - Spindle Guard Leg*
 - Lab Stand (Model G) (p50)
 - Convenience Pack
 - Cleaning Cloth, Screen Protectors
 - Carrying Case
- *Not applicable to HA or HB torque models

Optional Accessories

- RheocalcT Software ▶
- Label Printer (p51)
- Vane Spindles (p43 & 48)
- Ball Bearing Suspension (p50)
- Viscosity Standards (p52)
- RV/HA/HB-1 Spindle (p45)
- EZ-Lock Spindle Coupling System (p50)
- Quick Action Lab Stand (p50)
- Temperature Bath (p33-35)
- Small Sample Adapter (p38)
- UL Adapter (p40)
- Thermosel (p36)
- Helipath Stand with T-bar Spindles (p42)
- Spiral Adapter (p44)
- DIN Adapter (p44)
- Quick Connect/Extension Links (p49)

MODEL	VISCOSITY RANGE cP(mPa•s)		SPEEDS (2600 available)	
	Min.	Max.	RPM	Number of Increments
DV3TLV	1†	6M	.01-250	2.6K
DV3TRV	100††	40M	.01-250	2.6K
DV3THA	200††	80M	.01-250	2.6K
DV3THB	800††	320M	.01-250	2.6K
DV3T5xHB	4K	1.6B	.01-250	2.6K

† 1 cP achieved with UL Adapter accessory. 15 cP on LV with standard spindles.
 †† Minimum viscosity is achieved with optional RV/HA/HB-1 spindle.
 B = 1 billion M = 1 million K = 1 thousand cP = Centipoise
 mPa•s = Millipascal•seconds

PG Flash Software Included

PROGRAM GENERATOR SOFTWARE FOR CUSTOMIZING TEST CRITERIA FOR ROUTINE PRODUCT QC

This exclusive AMETEK Brookfield software allows you to create repeatable custom tests on your PC! Once the program (up to 25 steps) is created, it can be downloaded to a supplied USB flash drive and then uploaded to any DV3T Viscometer.



PG Flash allows users to create repeatable custom tests with all of the built-in options on the DV3T plus the addition of multiple program lines (up to 25 steps). Create the program on the PC and download to a USB Flash Drive. Upload the program from the USB Flash Drive to the DV3T.

RheocalcT Software Optional (see p14 for more details)

GET TOTAL CONTROL OF YOUR INSTRUMENT AND TEST PARAMETERS

Automatically control the instrument and collect data with RheocalcT running on a dedicated PC with USB interface. RheocalcT can analyze data, generate multiple plot overlays, print tabular data, run math models and perform other time-saving routines. Up to five comparison data sets can be plotted and saved. Other features include:

- Wizards to guide you through the creation of common tests
- Yield Testing, alone, or in conjunction with other viscosity measurements
- Secure 21CFR features including multiple logins, access levels, digital signatures, and data storage in a password-protected database
- Looping functions for repetitive tasks
- Averaging of collected data by individual step or whole test
- Math models: Bingham, Casson, Power Law, Herschel-Bulkley
- Export data to Excel® file format
- Create data reports in PDF format

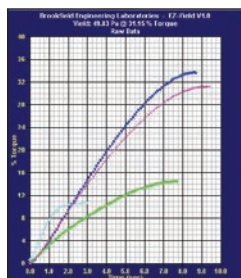
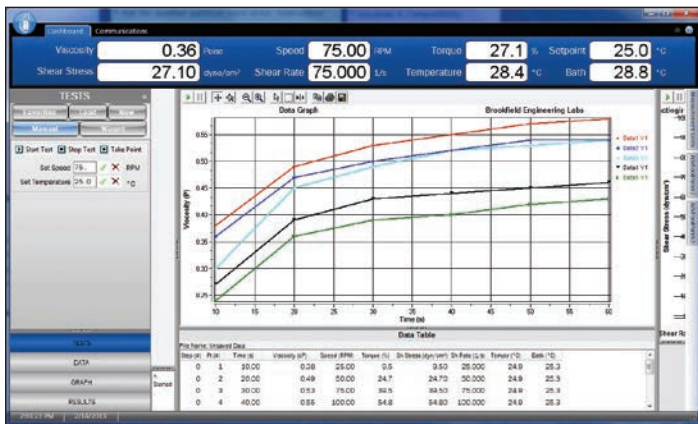

TORQUE RANGE		SHEAR STRESS RANGE	
		Pa	dyne/cm ²
LV	Contact Brookfield		
RV	.5-100	5-1K	
HA	1-200	10-2K	
HB	4-800	40-8K	
5xHB	20-4K	200-40K	

Yield tests can be performed with the use of optional vane spindles.



DV3TCP

The DV3T is available in a Wells/Brookfield Cone & Plate Version. Must be ordered when instrument is first purchased. (p20)



DV3T with Optional Vane Spindles

DV3T Rheometers have a built-in yield stress measurement capability that determines the stress required to initiate flow of slow moving or paste materials. Vane spindles can be immersed into a material without destroying the underlying structures that contribute to yield. The DV3T offers test parameters that create a specific yield test protocol that can be utilized for QC testing or research.

DV3T Extra

Includes our ball bearing suspension system, EZ-Lock Spindle Coupling System, Quick Action Lab Stand and FREE RheocalcT software.

DV2T™ Viscometer

our most versatile continuous sensing viscometer

5.7-inch Full Color Touch Screen Display

- New User Interface
- Enhanced Controls
- Real Time Trend Indicator
- Supports Multiple Languages

Displayed Info:

- Viscosity (cP or mPa•s)
- Temperature (°C or °F)
- Shear Rate/Stress
- % Torque
- Speed/Spindle
- Step Program Status

Enhanced Security

- Customizable User Access
- Date and Time Stamp File
- Password Access
- Portable Log-in Settings

Built-in Options

- Timed Tests
- Data Averaging
- Programmable QC Limits/Alarms
- Customizable Speed/Spindle Lists
- Test Based User Instructions
- On Screen Data Comparison

Auto Range Showing

- Maximum viscosity measured with Spindle/Speed combination

USB PC Interface provides optional computer control and automatic data gathering capability



Convenient Bubble Level

Download custom test programs with PG Flash Software (included with instrument)

Accuracy: ±1.0% of range
- Displayed with test data

Repeatability: ±0.2%

Built-in RTD Temperature Probe

Internal Data Storage: 150 MB

What's Included?

- Instrument
 - 6 spindles (RV/HA/HB) (p45) or 4 spindles (LV) (p45)
 - PG Flash Software ▶
 - RTD Temperature Probe
 - Spindle Guard Leg*
 - Lab Stand (Model G) (p50)
 - Convenience Pack
 - Cleaning Cloth, Screen Protectors
 - Carrying Case
- *Not applicable to HA or HB torque models

Optional Accessories

- RheocalcT Software ▶
- Label Printer (p51)
- Vane Spindles (p43 & 48)
- Ball Bearing Suspension (RV/HA/HB) (p50)
- Viscosity Standards (p52)
- RV/HA/HB-1 Spindle (p45)
- EZ-Lock Spindle Coupling System (p50)
- Quick Action Lab Stand (p50)
- Temperature Bath (p33-35)
- Small Sample Adapter (p38)
- UL Adapter (p40)
- Thermosel (p36)
- Helipath Stand with T-bar Spindles (p42)
- Spiral Adapter (p44)
- DIN Adapter (p44)
- Quick Connect/Extension Links (p49)

MODEL	VISCOSITY RANGE cP(mPa•s)		SPEEDS (200 available)	
	Min.	Max.	RPM	Number of Increments
DV2TLV	1†	6M	.1-200	200
DV2TRV	100††	40M	.1-200	200
DV2THA	200††	80M	.1-200	200
DV2THB	800††	320M	.1-200	200

† 1 cP achieved with UL Adapter accessory. 15 cP on LV with standard spindles.
†† Minimum viscosity is achieved with optional RV/HA/HB-1 spindle.
M = 1 million cP = Centipoise mPa•s = Millipascal•seconds

PG Flash Software Included

PROGRAM GENERATOR SOFTWARE FOR CUSTOMIZING
TEST CRITERIA FOR ROUTINE PRODUCT QC

This exclusive AMETEK Brookfield software allows you to create repeatable custom tests on your PC! Once the program (up to 25 steps) is created, it can be downloaded to a supplied USB flash drive and then uploaded to any DV2T Viscometer.

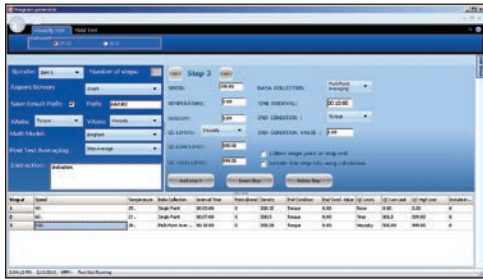

PG Flash allows users to create repeatable custom tests with all of the built-in options on the DV2T plus the addition of multiple program lines (up to 25 steps). Create the program on the PC and download to a USB Flash Drive. Upload the program from the USB Flash Drive to the DV2T.

RheocalcT Software Optional (see p14 for more details)

GET TOTAL CONTROL OF YOUR INSTRUMENT AND TEST PARAMETERS

Automatically control the instrument and collect data with RheocalcT running on a dedicated PC with USB interface. RheocalcT can analyze data, generate multiple plot overlays, print tabular data, run math models and perform other time-saving routines. Up to five comparison data sets can be plotted and saved. Other features include:

- Wizards to guide you through the creation of common tests
- Secure 21CFR features including multiple logins, access levels, digital signatures, and data storage in a password-protected database
- Looping functions for repetitive tasks
- Averaging of collected data by individual step or whole test
- Math models: Bingham, Casson, Power Law, Herschel-Bulkley
- Export data to Excel® file format
- Create data reports in PDF format



DV2TCP

The DV2T is available in a Wells/Brookfield Cone & Plate Version
Must be ordered when instrument is first purchased. (p20)



DV2T EXTRA™ Viscometer

The “EXTRA” combines all the versatile viscosity testing capabilities of a DV2T with time and money-saving features such as a durable ball bearing suspension system, EZ-Lock Spindle Coupling, Quick Action Lab Stand and FREE Rheocalc T Software.

DV1™ Viscometer

The only viscometer in its class to offer continuous sensing and data display at such a low price!

User Configuration Display

- User choice of most important parameter is displayed in larger font size
- Choice of static or scrolling display mode

Displayed Info:

- Viscosity (cP, P, mPa•s, Pa•s)
- % Torque
- Speed/Spindle
- Temperature (°C or °F)
if RTD Temperature Probe is purchased

Choice of Multiple Languages

English, French, German, Portuguese, Russian, Spanish

USB PC interface for use with optional Wingather SQ Software

18 speeds provide great range capability

Optional RTD Temperature Probe DVP-94Y

Direct access to time measurement function (time to torque, time to temperature, time to stop)

Accuracy:
±1.0% of range

Repeatability: ±0.2%

Temperature off-set capability to ±5°C

Automatic Range Calculation:

- Full Scale Range (FSR) at 100%
- Maximum viscosity measured with Spindle/Speed combination



Simplified User interface for more direct access to features

Printing to Dymo® Printer Capability

Stylish Model G Base

What's Included?

- Instrument
 - 6 spindles (RV/HA/HB) (p45) or 4 spindles (LV) (p45)
 - Spindle Guard Leg*
 - Lab Stand (Model G) (p50)
 - Carrying Case
- *Not applicable to HA or HB torque models

Optional Accessories

- Wingather SQ Software ▶
- RTD Temperature Probe
- Ball Bearing Suspension (RV/HA/HB) (p50)
- EZ-Lock Spindle Coupling System (p50)
- Viscosity Standards (p52)
- Protective Keypad Covers (p51)
- Dymo Printer (p51)
- RV/HA/HB-1 Spindle (p45)
- Quick Action Lab Stand (p50)
- Temperature Bath (p33-35)
- Small Sample Adapter (p38)
- UL Adapter (p40)
- Thermosel (p36)
- Helipath Stand with T-bar Spindles (p42)
- Spiral Adapter (p44)
- DIN Adapter (p44)
- Quick Connect/Extension Links (p49)
- Vane Spindles (p43 & 48)

MODEL	VISCOSITY RANGE cP(mPa•s)		SPEEDS	
	Min.	Max.	RPM	Number of Increments
DV1MLV	1*	2M	.3-100	18
DV1MRV	100	13M	.3-100	18
DV1MHA	200	26M	.3-100	18
DV1MHB	800	104M	.3-100	18

* Minimum ranges can be extended to as low as 1 cP with the use of accessories

** Standard torque range values

M = 1 million cP = Centipoise mPa•s = Millipascal•seconds

Wingather SQ Software Optional (see p14 for more details)
 DATA COLLECTION SOFTWARE TO COLLECT, ANALYZE AND RECORD TEST DATA

Wingather software provides an easy way to gather data and plot graphs while creating permanent test records.

Important features and benefits enhance operator versatility in performing viscosity tests:

- Multiple test modes to enhance data collection
- Follow up events including analysis through math models which calculate yield stress and plastic index
- Automatic sample numbering
- Data graphing of up to 20 data sets concurrently
- Data export to spread sheet format (Excel®)

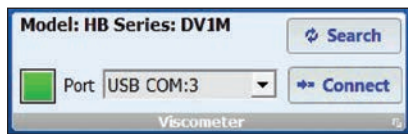

The DV1 Viscometer communicates to the PC through USB A port. The interface cable is supplied with Wingather SQ Software. Successful communication is indicated by a green light beside the port designation.



DV1CP

The DV1 is available in a Wells/Brookfield Cone & Plate Version
 Must be ordered when instrument is first purchased. (p20)

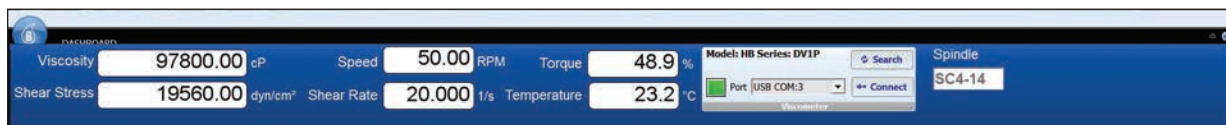

Dashboard shows current test information.

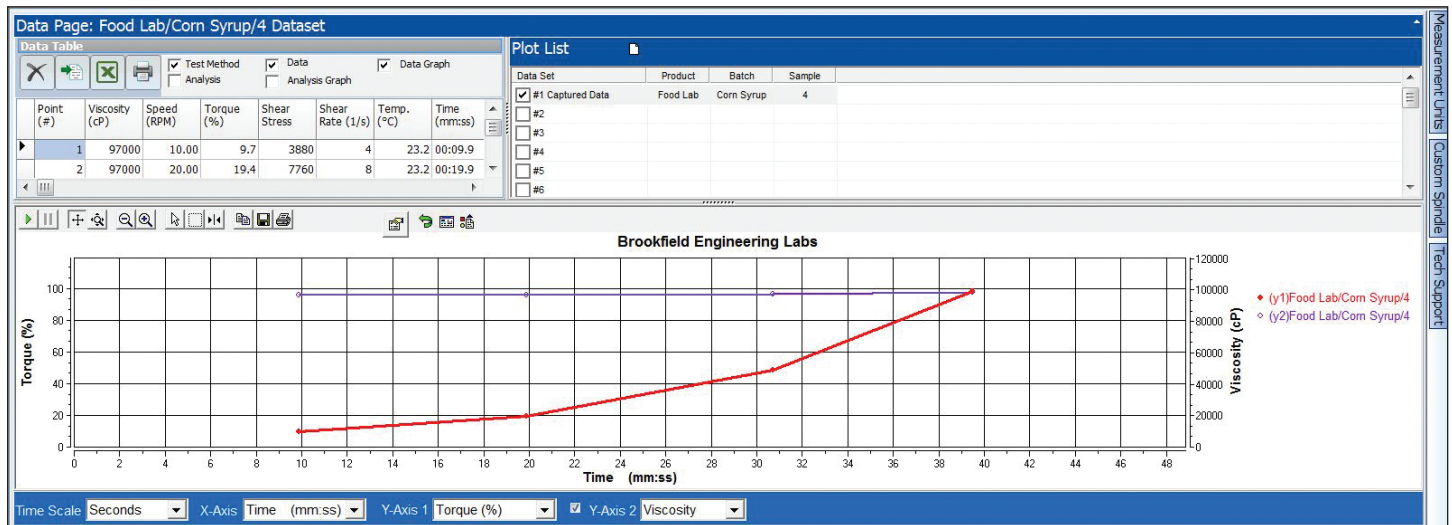

Data table and graph shows test record at a glance.

Do You Need Software?

Which instrument/software combination is best for you?

Using software with your AMETEK Brookfield DV1, DV2T and DV3T has many advantages. Software enhances the capabilities of your instrument and allows for a more productive environment as automated tasks reduce test time and operator errors. Which instrument/software combination is best for you? This decision can easily be made by determining which features are the most important to your operation and seeing which instrument has the capabilities that best suits your overall requirements.

RheocalcT Test Wizards

Like wizards used in every day office software programs, RheocalcT test wizards are there to reduce the time and effort needed to set up or run a test. RheocalcT test wizards run a thix index test (calculate the ratio of viscosity at low speed vs. viscosity at a higher speed) or control the instrument to automatically reduce speed at preset torque values (curing test). Some other test methods that can easily be created with the RheocalcT test wizard include:

- Time to stop
- Time to torque
- Speed ramp / shear rate ramp
- Temperature profiling
- Yield stress test (DV3T)

FEATURES & BENEFITS available with software	RheocalcT		Wingather SQ
	DV3T	DV2T	DV1
Connect instrument to PC with USB port	•	•	•
Plot live data with graphical view of viscosity during tests	•	•	•
Import legacy templates and test data	•	•	•
Export data to Excel-compatible file format	•	•	•
Create data reports in .pdf file format	•	•	•
Create tests for various conditions using built-in test methods	•	•	•
Run yield stress test with EZ-Yield program	•		
Compare multiple test results on a single graph	•	•	•
Analysis through math models (yield stress and plastic index)	•	•	•
Analysis through math models (Bingham, Casson, Power Law, Herschel-Bulkley)*	•	•	•
Button click to access up to five stored programs			•
Store and easily access up to 10 programs	•	•	
Transfer collected data to a PC through thumb drive	•	•	•
Customized data graphs	•	•	•
Generate multiple plot overlays and print tabular data	•	•	
Test wizard for quick and easy test method creation	•	•	
Security features for user access and data integrity (21CFR P11)	•	•	
Ability to control Brookfield Temperature Bath and ThermoSol	•	•	
Looping function for repetitive tasks	•	•	
Data collection averaging by individual steps or entire test	•		

*Math models feature is available in DV3T with or without RheocalcT software.

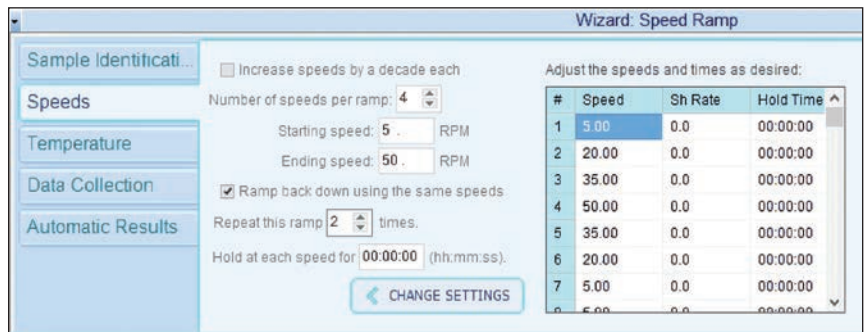

Test Condition Entry Screen for Speed Test Wizard

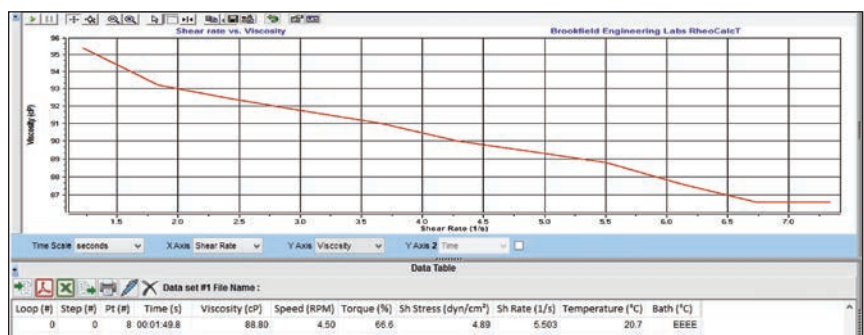

Example of RheocalcT Speed Test Results

DVE™ Viscometer

our most affordable digital viscometer

New User Interface

- Keypad control
- Sharp viewing screen for close up or distance viewing

No calculations required

- Direct reading of viscosity

Displayed Info:

- Viscosity (cP, P, mPa•s or Pa•s)
- % Torque
- Speed/Spindle

Easy-to-Use

Range

push for determining full scale range (FSR) viscosity

18 Speeds

for complete range capability

Bubble level

conveniently located for easy adjustment

Accuracy: ±1.0% of range

Repeatability: ±0.2%



What's Included?

- Instrument
- 6 spindles (RV/HA/HB) (p45)
- or 4 spindles (LV) (p45)
- Spindle Guard Leg*
- Lab Stand (Model A) (p50)
- Carrying Case
- *Not applicable to HA or HB torque models

Optional Accessories

- Viscosity Standards (p52)
- RV/HA/HB-1 Spindle (p45)
- Quick Action Lab Stand (p50)
- Temperature Bath (p33-35)
- Small Sample Adapter (p38)
- UL Adapter (p40)
- Thermosel (p36)
- DIN Adapter (p44)
- Quick Connect/Extension Links (p49)

MODEL	VISCOSITY RANGE cP(mPa•s)		SPEEDS	
	Min.	Max.	RPM	Number of Increments
DVELV	1†	2M	.3-100	18
DVERV	100††	13M	.3-100	18
DVEHA	200††	26M	.3-100	18
DVEHB	800††	104M	.3-100	18

† 1 cP achieved with UL Adapter accessory. 15 cP on LV with standard spindles.

†† Minimum viscosity is achieved with optional RV/HA/HB-1 spindle.

M = 1 million cP = Centipoise mPa•s = Millipascal•seconds

Dial Reading Viscometer

our original...over 80 years!

The Worldwide Standard
Viscometer

Easy-to-Select Speeds

Electronic Drive
means quiet,
reliable operation

Analog display
- Shows % Torque
- Use Factor Finder
to convert reading
to centipoise

Simple-to-use,
easy setup

2-Year Limited Warranty

Available in explosion proof
U.L. Class 1, Division 1,
Group D locations
(w/o Electronic Drive)

Accuracy: $\pm 1.0\%$ of range

Repeatability: $\pm 0.2\%$



What's Included?

- Instrument
 - 6 spindles (RV/HA/HB) (p45)
or 4 spindles (LV) (p45)
 - Spindle Guard Leg*
 - Lab Stand (Model A) (p50)
 - Carrying Case
- *Not applicable to HA or HB torque models

Optional Accessories

- Viscosity Standards (p52)
- RV/HA/HB-1 Spindle (p45)
- Quick Action Lab Stand (p50)
- Temperature Bath (p33-35)
- Small Sample Adapter (p38)
- UL Adapter (p40)
- Thermosel (p36)
- Spiral Adapter (p44)
- DIN Adapter (p44)
- Quick Connect/Extension Links (p49)
- Vane Spindles (p43 & 48)

MODEL	VISCOSITY RANGE cP(mPa*s)		SPEEDS	
	Min.	Max.	RPM	Number of Increments
LVT	1†	2M	.3-60	8
RVT	100††	8M	.5-100	10
HAT	200††	16M	.5-100	10
HBT	800††	64M	.5-100	10

† 1 cP achieved with UL Adapter accessory. 15 cP on LV with standard spindles.
†† Minimum viscosity is achieved with optional RV/HA/HB-1 spindle.
M = 1 million cP = Centipoise mPa*s = Millipascal*seconds



*Easy Speed
Adjustment
and On/Off
Control*

NEW KU-3™ Viscometer

for Paints, Coatings, and Inks

ASTM D562 Compatible
(industry specification)

New Magnetic Spindle Coupling

New User Interface
with touch control & auto-start

New Single Piece Can Adapter
for pint and 1/2 pint cans
Accommodates quart cans

Easy to use
no weights, simplifies an
established test procedure

LED Display Info:

- Krebs Units
- Gram Units
(Weight)
- Centipoise*

Select Krebs or Grams or Centipoise

Lock-In Test Results
with Hold button

Accuracy: $\pm 1.0\%$ of range

Repeatability: $\pm 0.5\%$

Standard Krebs Spindle

Measurement range:
40 to 141 KU, 32 to 1099 gm,
and 27 to 5274 cP*



What's Included?

Instrument
Krebs-type Spindle (p48)
Adapter for Quart, Pint and
Half-Pint Cans

Optional Accessories

Paste Spindle (p48)

Applications

Paints
Coatings
Adhesives
Inks
Pastes

*Centipoise values based on the conversion from Krebs
Units as defined in the ASTM D562.

Falling Ball Viscometer

...Newtonian measurements made simple and easy!

The AMETEK Brookfield Falling Ball Viscometer uses the simple — but precise — Höppler principle to measure the viscosity of Newtonian liquids by measuring the time required for a ball to fall under gravity through a sample-filled tube.

Complies with DIN 53015

Set of six balls to test a wide variety of samples

Connection to circulating bath for temperature control of sample

Temperature Probe

Pivot bearing allows for quick and easy tube rotation for repeat test

Model KF40 (shown) variable angle (50°; 60°; 70° & 80°) for non-Newtonian fluids

Model KF30 (also available) fixed angle

Viscosity Range:
0.5 to 70,000
mPa•s (cP)

Accuracy:
0.5% to 2.0%
(depending on ball used)



What's Included?

- Instrument
- Set of six (6) balls
- Temperature Probe
- Carrying Case

Optional Accessories

- Temperature Bath (p33-35)
- Viscosity Standards (p52)
- Special Temperature Probes

Applications

- Beverages
- Coatings
- Cosmetics
- Detergents
- Food
- Paint
- Petroleum Products
- Pharmaceuticals
- Polymers
- Soap



KF40 with Bath

Use with a AMETEK Brookfield Circulating Bath permits rapid temperature control of sample for more accurate and repeatable results.

SPECIFICATIONS

Viscosity Range:	0.5 mPa•s (cP) to 70,000 mPa•s (cP)	
Accuracy:	0.5% - 2.0% depending on choice of ball	
Ball set Material of Construction:	Balls 1 and 2:	Boron Silicate Glass
	Balls 3 and 4:	Nickel-iron
	Balls 5 and 6:	Steel
Ball Diameter:	11.0 mm to 15.81 mm	
Fall Time of Ball in Measurement:	30 to 300 seconds**	
Length of Measurement Zone in the Tube:	100 mm	
Operating Temperature Range:	-5°C to +150°C	
Sample Tube Volume:	40mL	
Viscometer Dimensions:	180 x 220 x 330 mm	

**Falling times greater than 300 seconds allow measurement of liquids above 70,000 mPa•s (cP)

NEW Gel Timer Instrument

for gel coats, resins, potting compounds

Replacement for Sunshine Gel Timer instrument

Instrument System

- Choice of Viscometer or Rheometer
- Magnetic Coupling with Glass Rod
- Temperature Probe

Test Method

- Determine torque value that correlates with gel time
- Select Time-To-Torque Test
- Immerse Rod in Sample
- Start Test:
 - Rod rotates at 1 rpm
- Gel time occurs when defined torque value is achieved

Easy to Use

- Glass rod fits snugly in compression-fit coupling
- Time to torque test method runs automatically
- Quick disconnect for rod at conclusion of test

Displayed Information

- Gel time
- Continuous temperature readout in °C or °F



What's Included?

Choice of instrument:

Recommended: DV2TRV Viscometer

Options: DV3T or DV1M

GT-2000

Magnetic Coupling (for 6 mm dia. rod)

Glass Rod (6 mm diameter)

Lab Stand with stop

for controlled immersion depth of rod

Temperature Probe (with DV2T, DV3T)

(option on DV1M)

Optional Accessories

Ball Bearing Suspension
(not available with LV Torque)

EZ-Lock Coupling for instrument head

EZ-Lock Rod Coupling System
(requires YU-20C)

Hook Couplings (SP1-UC-Y, YDX-1)
for Rod Coupling System

Rheocalc T Software (DV2T and DV3T)

Wingather SQ Software (DV1M)

GT-1010 - Pack of 10 glass rods

Wells/Brookfield™ Cone & Plate

optional small sample configuration for DV3T, DV2T & DV1 Available only when instrument is first purchased



Determine absolute viscosity of small samples (0.5 – 2.0 mL)

Available in these models

- DV3T Rheometer
- DV2T Viscometer
- DV1 Viscometer

Accuracy: ±1.0% of range

Repeatability: ±0.2%

Electronic Gap Adjustment™

- Simplified setup
- Accurate
- Easy-to-use

RTD Temperature Sensor

in Sample Cup (Optional) provides direct measurement of sample temperature

Control Sample Temperature

using an AMETEK Brookfield circulating water bath (p27)

Rapid temperature control

due to small sample size

Recommended

Temperature Range:
5°C to 80°C

Precise shear rates

for determining a material's flow curve behavior

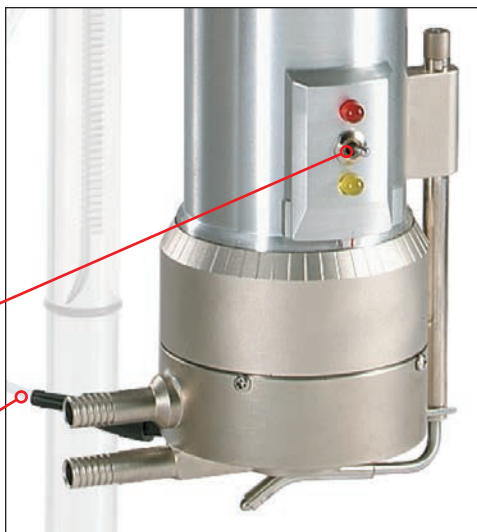

What's Included?

- Instrument
- Lab Stand (p50)
- Choice of one Cone Spindle (p46)
- Sample Cup (p46)

Optional Accessories

- Embedded Temperature Probe in Sample Cup (p46)
- Luer and Purge fittings
- Ball Bearing Suspension (p50)
- Additional Cone Spindles (p46)
- Viscosity Standards (p52)
- Circulating Temperature Bath (p33-35)
- RheocalcT Software ▶ (DV3T & DV2T only)
- Wingather SQ Software ▶ (DV1 only)
- Protective Keypad Covers (p51)

Viscosity Range* cP(mPa•s)

MODEL	Cone Spindle: CPA-40Z Sample Volume: .5mL Shear Rate (sec ⁻¹): 7.5N		Cone Spindle: CPA-41Z Sample Volume: 2.0mL Shear Rate (sec ⁻¹): 2.0N		Cone Spindle: CPA-42Z Sample Volume: 1.0mL Shear Rate (sec ⁻¹): 3.84N		Cone Spindle: CPA-51Z Sample Volume: .5mL Shear Rate (sec ⁻¹): 3.84N		Cone Spindle: CPA-52Z Sample Volume: .5mL Shear Rate (sec ⁻¹): 2.0N		SPEEDS	
	Range	Range	Range	Range	Range	Range	Range	RPM	Number of Increments			
DV3TLVCP	.1 - 3K	.5 - 11K	.2 - 6K	2 - 48K	3 - 92K	.01 - 250	2.6K					
DV2TLVCP	.2 - 3K	.6 - 11K	.3 - 6K	2 - 48K	4 - 92K	0.1 - 200	200					
DV1MLVCP	.3 - 1K	1 - 3K	.6 - 2K	5 - 16K	9 - 30K	0.3 - 100	18					
DV3TRVCP	1 - 32K	5 - 122K	2 - 64K	20 - 512K	39 - 983K	.01 - 250	2.6K					
DV2TRVCP	1.6 - 32K	6 - 122K	3 - 64K	25 - 512K	49 - 983K	0.1 - 200	200					
DV1MRVCP	3 - 10K	12 - 41K	6 - 21K	51 - 170K	98 - 327K	0.3 - 100	18					
DV3THACP	2.6 - 65K	10 - 245K	5 - 128K	41 - 1M	78 - 2M	.01 - 250	2.6K					
DV2THACP	3 - 65K	12 - 245K	6 - 128K	51 - 1M	98 - 2M	0.1 - 200	200					
DV1MHACP	6.6 - 21K	24 - 81K	12 - 42K	102 - 341K	196 - 655K	0.3 - 100	18					
DV3THBCP	10.5 - 261K	39 - 982K	20 - 512K	163 - 4M	314 - 7.8M	.01 - 250	2.6K					
DV2THBCP	13 - 261K	49 - 982K	25.6 - 512K	204 - 4M	393 - 7.8M	0.1 - 200	200					
DV1MHBCP	26 - 87K	98 - 327K	51 - 170K	409 - 1M	786 - 2.6M	0.3 - 100	18					

M = 1 million K = 1 thousand cP = Centipoise mPa•s = Millipascal•seconds mL = Milliliter N = RPM e.g. Spindle CPA-40Z 7.50 x 10 (rpm) = 75.0 sec⁻¹
* Dependant upon cone selected.

RheocalcT Software Optional for DV2T and DV3T (see p14 for more details)
 GET TOTAL CONTROL OF YOUR INSTRUMENT AND TEST PARAMETERS

Automatically control and collect data with RheocalcT and a dedicated computer. RheocalcT can analyze data, generate multiple plot overlays, print tabular data, run math models and perform other time-saving routines. Up to five comparison data sets can be plotted and saved. Other features include:

- Wizards to guide you through the creation of common tests
- Secure 21CFR features including multiple logins, access levels, digital signatures, and data storage in a password-protected database
- Looping functions for repetitive tasks
- Averaging of collected data by step or whole test
- Math models: Bingham, Casson, Casson NCA/CMA, Power Law, IPC Paste, Herschel-Bulkley, Thix Index



Optional Sample Cup

The Optional Sample Cup has luer and purge fittings for introducing and removing test sample while cup remains attached to instrument

Wingather SQ Software Optional for DV1 (see p14 for more details)
 DATA COLLECTION SOFTWARE TO COLLECT, ANALYZE AND RECORD TEST DATA

Wingather software provides an easy way to gather data and plot graphs while creating permanent test records. Data can be saved in the program or exported to Excel.

- Automates data collection to save time
- Reduces operator error
- Math modeling for yield stress calculations, plastic index
- Plot up to four data sets for comparisons

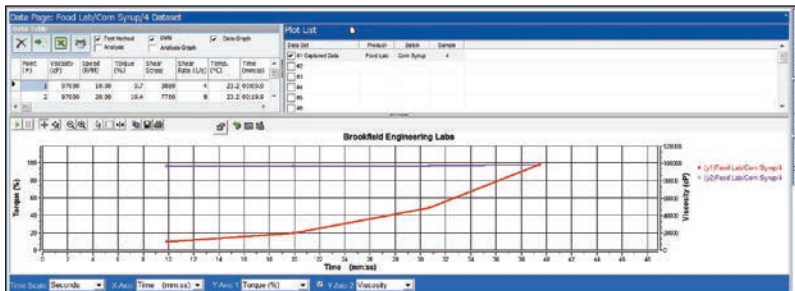

CAP 1000+™ & CAP 2000+™

Cone & Plate Viscometers - appropriate for moderate to high shear tests

Keypad for direct input of test parameters

Cone Spindle is easily removed for cleaning

Easy-to-Use Control Handle for accurate, automatic cone positioning

Designed to handle repetitive testing in production environments with easy setup and cleaning

4-Line Display allows simultaneous viewing of all test parameters

Choice of instruments:
CAP 1000+ (single speed)
CAP 2000+ (variable speed)

Automatic cone/gap positioning

Small sample size
less than 1 mL

Built-in Peltier Plate for temperature control of sample:
L Series: 5°C — 75°C
H Series: 50°C — 235°C



What's Included?

- Instrument
- Choice of Torque Range:
High Torque (ICI Specification): 181,000 dyne • cm
Low Torque: 7,970 dyne • cm
- Choice of One Cone Spindle (p42)
- Choice of Temperature Control: L or H

Optional Accessories

- CAP Viscosity Standards (p53)
- Additional Cone Spindle (p46)
- Capcalc32 Software ▶
- Protective Keypad Covers (p51)

CAP 1000+

Single speed 750 or 900 rpm instrument, ideal for QC. Optional choice of alternative speed is available upon request. See examples below at 400 rpm and 100 rpm.

CAP 2000+

Variable speed 5-1000 rpm instrument ideal for R&D as well as more detailed QC testing. Automated PC control (using optional Capcalc32 software).

MODEL	VISCOSITY RANGE cP(mPa•s)		SPEEDS	
	Min.	Max.	RPM	Number of Increments
CAP 1000+	see next page		900/750	2
CAP 2000+	for each cone		5-1K	995

* Dependant on cone selected.
M = 1 million K = 1 thousand cP = Centipoise mPa•s = Millipascal•seconds

Capcalc32 Software Optional

TURN YOUR CAP 2000+ VISCOMETER INTO A MORE POWERFUL RHEOMETER

Capcalc32 allows control of the CAP 2000+ Viscometer while providing automatic data capture and graphical display. Automate your CAP 2000+ Viscometer and generate flow curves quickly and easily.

- Controls test parameters with powerful scripting capabilities
- Looping functions for repetitive tasks
- Automates data collection to save time
- Reduces operator error
- Math modeling for yield stress calculations, plastic index
- Plot up to four data sets for comparisons

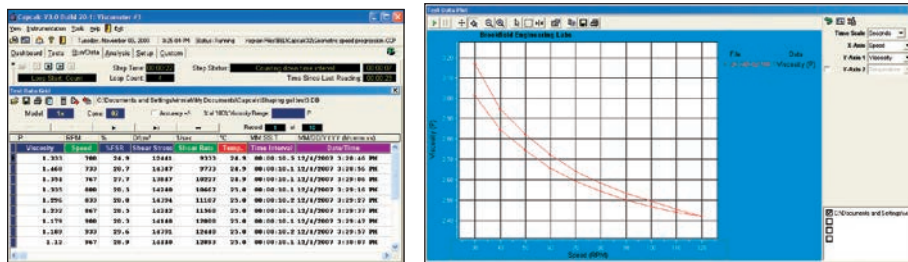

Applications

MEDIUM VISCOSITY

Adhesives (hot melt)	Coatings	Resins
Architectural Coatings	Industrial Coatings	Starches
Autocoats (Hi-performance)	Inks (screen printing)	Surface
Creams	Organisols	UV Coatings
Food Products	Paints	Varnish
Gels	Paper Coatings	
Gums	Plastisols	

HIGH VISCOSITY

Adhesives	Gels	Sealants
Asphalt	Inks (ballpoint, offset, lithographic)	Sheet Molding
Compound		
Chocolate	Molasses	Tars
Composite Polymers	Pastes	Vinyl Esters
Epoxies	Roofing Compounds	

Perfect for Paints & Coatings

Meets Industry Standards:
ASTM D4287, ISO 2884, BS 3900
High Shear Rate Cone & Plate
(10,000 sec⁻¹)

MODEL	Shear Rate (sec ⁻¹): 13.3N Sample Volume: 67µL Cone Spindle: CAP-01	Shear Rate (sec ⁻¹): 13.3N Sample Volume: 39µL Cone Spindle: CAP-02	Shear Rate (sec ⁻¹): 13.3N Sample Volume: 24µL Cone Spindle: CAP-03	Shear Rate (sec ⁻¹): 13.3N Sample Volume: 13.3µL Cone Spindle: CAP-04	Shear Rate (sec ⁻¹): 3.3N Sample Volume: 67µL Cone Spindle: CAP-05	Shear Rate (sec ⁻¹): 3.3N Sample Volume: 39µL Cone Spindle: CAP-06	Shear Rate (sec ⁻¹): 3.3N Sample Volume: 24µL Cone Spindle: CAP-07	Shear Rate (sec ⁻¹): 2.0N Sample Volume: 170µL Cone Spindle: CAP-08	Shear Rate (sec ⁻¹): 2.0N Sample Volume: 100µL Cone Spindle: CAP-09	Shear Rate (sec ⁻¹): 5.0N Sample Volume: 170µL Cone Spindle: CAP-10
HIGH TORQUE										
1000+ @750rpm	.25-2.5	.5-5	1-10	2-20	4-40	10-100	N/A	N/A	N/A	N/A
1000+ @900rpm	.2-2	.4-4	.8-8	1-16	3-33	8-83	N/A	N/A	N/A	N/A
1000+ @400rpm	.375-4.6	.75-9.3	1.5-18.7	3-37.5	6-75	15-187	.78-7.81*	3.13-31.3*	12.5-125*	1-10*
2000+ @5-1000rpm	.2-375	.4-750	.8-1.5K	1-3K	3-6K	8-15K	.78-625*	3.13-2.5K*	12.5-10K*	1-1K*
LOW TORQUE (for applications requiring low shear rates for low/medium viscosity fluids, an optional low torque 797-7,970 dyne•cm instrument can be ordered)										
1000+ @100rpm†	.2-.81	.2-1.6	.33-3.3	.65-6.5	1.3-13	3.3-33	.13-1.3	.54-5.4	2.2-22	.22-2.2
2000+ @5-1000rpm	.2-16	.2-32	.2-66	.2-130	.2-260	.2-660	.2-26	.2-108	.2-440	.2-44

µL = microliter K = 1 thousand P = poise 1 Pa•s = 10 poise N = RPM e.g. Cone CAP-01 13.3 x 10 (rpm) = 133 sec⁻¹
*Maximum speed recommended with this spindle is 400 rpm. Viscosity range indicated is for operation at 400 rpm. †Special speed instrument.
Note: Viscosity ranges shown above are for illustration. The exact range will depend upon instrument configuration.

RST Touch™ Series Rheometers

Touch Screen Rheometers for Controlled Rate/Stress Measurement

The RST series of touch screen rheometers represents the best that AMETEK Brookfield has to offer — instruments that operate both in controlled shear rate (rpm) and controlled shear stress (torque) modes — for sophisticated rheological analysis. With automatic data collection and analysis using optional Rheo3000 software, RST Rheometers offer greater flexibility and more features than other high-end rheometers in their class — at a fraction of the cost.

RST Rheometers have a durable design with rapid bob (spindle) attachment and easy-to-clean surfaces for years of trouble-free operation. Increased measurement capabilities range from simple single-point viscosity tests to comprehensive rheological profiling. Evaluate material behavior from initial yield stress through full flow curve response at variable shear rates to relaxation, recovery and creep.

The RST touch screen series is available in three configurations and all models feature:

- Controlled stress/rate operation to analyze comprehensive flow behavior
- User friendly LCD touch screen with graphical display
- 11 memory slots for structured multi-step test programs
- Auto spindle identity recognition
- Quick connect coupling for easy spindle attachment
- Optional Rheo 3000 Software for PC control and data management
- 21 CFR compliance for controlled user access and data security

A portable version without touch screen capability (Model RS Portable) is also available.

RST Technical Specifications (all models)

Maximum Torque:	100 mNm
Torque Resolution:	0.15 μNm
Speed:	0.01 to 1300 rpm
Data Output:	USB, RS232
Display Units:	cP, Pa•s, dynes/cm ² , Pa, °C, °F

Some popular applications include:

ADHESIVES: RST-CPS tests a variety of silicone-based adhesives at temperatures in excess of >200°C. Advantages include small sample volume (< 2mL), rapid temperature equilibrium with Peltier plate, variable shear rate (to 7,800 sec⁻¹) to duplicate conditions for actual adhesive use, quick test time (< 2 min).

ADHESIVE INGREDIENTS: RST-CPS with Peltier control excels at rapid QC measurements at defined shear rates. Optional Peltier plate changes temperature much more quickly than bath/circulator. Test throughput increases dramatically.

BIOMASS: RST-CC with vane spindle in coax chamber measures biomass fluids used for biofuel production. Easily handles suspended solids and evaluates important flow properties by simulating what happens to the material during pumping in production.

CHOCOLATE: RST-CC is instrument of choice for select manufacturers who run 24/7 operations requiring robust, reliable performance. Choice of optional serrated bob (spindle). Conforms to DIN and ISO test methods which quantify yield stress and consistency using Casson analysis. Affordable alternative to higher priced rheometers.

DAIRY: RST-CC with double-gap geometry measures low viscosity (<0.1 Pa•s) dairy products ranging from skim milk to thicker creams.

GYPSUM: RST-SST is popular choice for measurement of joint compound manufactured by the gypsum industry in accordance with ASTM C474. Small footprint, data display in BU units, and robust design make it ideal for lab and production floor use.

PESTICIDES: RST-CC with double-gap geometry measures various low viscosity formulations (0.001 Pa•s) at shear rates up to 5,600 sec⁻¹. Provides reliable capability in a busy QC lab measuring dozens of samples each day.

PHARMACEUTICAL: RST-CPS with open plate design for easy sample placement accommodates a variety of small sample sizes (< 4mL) and rapid temperature control using the Peltier option. Produces quick profiling of flow behavior, including yield stress and creep, important properties for characterizing ointments.

PIGMENT DISPERSIONS: RST-CPS with Peltier is used by a range of industrial markets, including plastics and paints. Handles broad viscosity range from thin formulations (0.025 Pa•s) to non-flowing pastes. Broad shear rate capability simulates both processing of materials (pumping and mixing) and application of material (brushing and spraying).

SAUCES AND SYRUPS: RST-CPS with Peltier replaces traditional hour-long viscosity tests which measure product from a cooking vessel after it cools to room temperature. Peltier option cools sample to 25°C in less than 1 minute, greatly reducing test time.

SLUDGE/SLURRIES/CONCRETE: RST-SST with vane spindle geometry measures diverse mixtures with particulates ranging in concentration up to 70% solids.

RST-CPS Touch™ Rheometer

Cone/Plate & Plate/Plate Systems for small samples and wide shear rate ranges

Controlled shear stress/shear rate operation makes it easy to study material behavior from initial yield to flow curve response

User-friendly Touch Screen and graphical display for stand-alone operation

Quick Connect Coupling System for easy spindle attachment

Very Small Sample Size permits rapid test set up and clean up

Spindle Barcode for auto spindle recognition

Optional Rheo3000 Software allows for PC control and data acquisition/analysis of multiple test files

Automatic or Manual Gap Setting for quick and easy gap setting

Rapid Temperature Control of plate with Peltier option for quick profiling of viscosity vs. temperature



What's Included?

Instrument (with choice of water bath or Peltier temperature control for sample plate)
Convenience Package (Cleaning Cloth, Screen Protector)

Optional Accessories

Choice of cone or plate spindle geometries at least one is required (p47)
Rheo3000 Software
Viscosity Standards (p53)
Water Baths (p33-35)
Solvent Trap
Choice of Thermal Barrier
- Teflon (0° - 200°C)
- Stainless Steel (0° - 200°C+)
KE Cooling Device



Choice of cone spindles and plate spindles accommodates all sample types. Plate spindles are used for highly-filled or very viscous samples.



Thermal Barrier reduces the effects of heat transfer to the environment. Two part chamber provides thermal isolation of the measurement zone.



The optional KE cooling device is required to cool viscometer bearings when testing with temperatures above 70°C.

MODEL	VISCOSITY RANGE (Pa•s)		SPEEDS
	Min.	Max.	RPM
RST-CPS Cone/Plate	0.0006	814K	0.01-1.3K
RST-CPS Plate/Plate	0.002	2.49M	0.01-1.3K

See page 47 for individual spindle (bob) ranges K = 1 thousand M = 1 million 1 Pa•s = 1000 cP (centipoise)

Temperature Control Options†		
MODEL	Description	Temperature
RST-CPS-FH	Bath	-20° to 200°C
RST-CPS-PA	Peltier Air	0° to 180°C*

† Higher temperatures available on request. * 75mm plates cannot be used with Peltier systems. See page 47 for spindle ranges and sample volumes.

RST-CC Touch™ Rheometer

Coaxial Cylinder DIN Geometries for single point QC or full rheological profiling

Spindle Barcode
for auto spindle recognition

Controlled shear stress/shear rate
operation makes it easy to study material behavior from initial yield to flow curve response

Optional Rheo3000 Software
allows for PC control and data acquisition/analysis of multiple test files

Quick Connect Coupling
for easy bob (spindle) attachment

Rugged Design
permits use on production floor

Small sample size
facilitates rapid temperature control during testing

Temperature Control from -20°C to 180°C
Choice of
- Direct immersion in bath
- External circulation using the FTKY3 Water Jacket

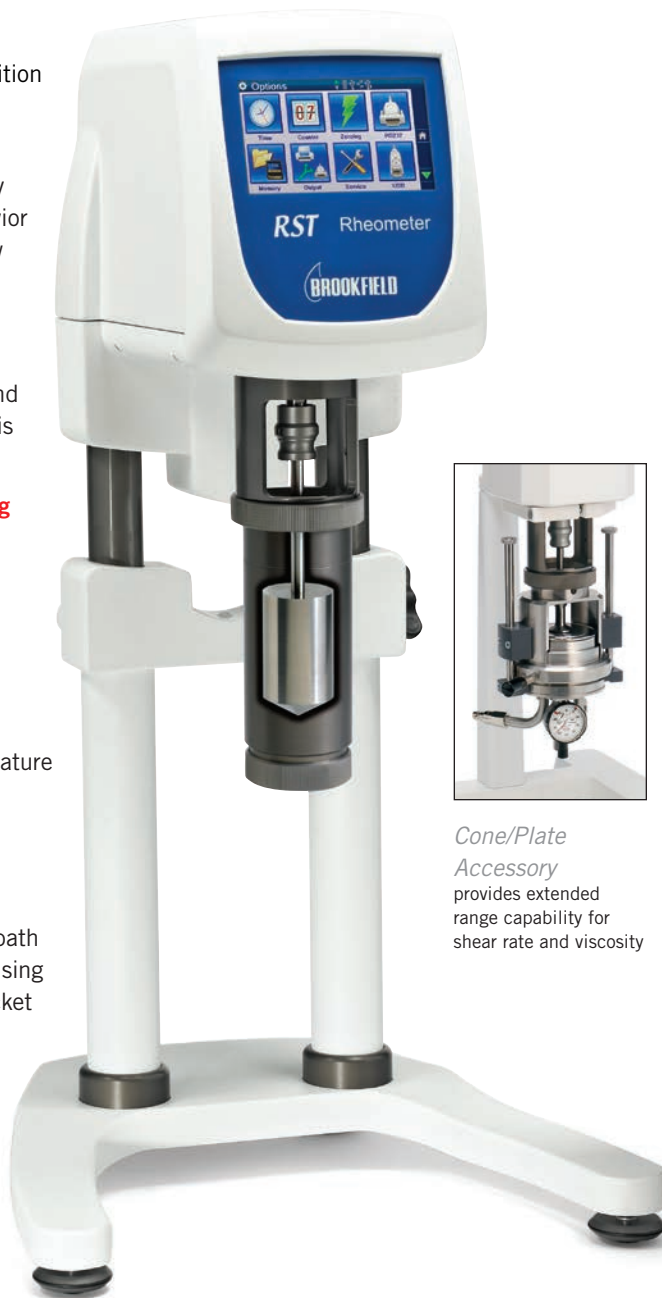

Cone/Plate Accessory
provides extended range capability for shear rate and viscosity

What's Included?

Instrument with stand and adjustable height control with base
Convenience Package (Cleaning Cloth, Screen Protector)

Optional Accessories

- Choice of Coaxial Cylinder Bob (spindle) and Chamber at least one bob and chamber is required (p47)
- FTKY3 Water Jacket for Temperature Control
- Rheo3000 Software (p29)
- Viscosity Standards (p53)
- Cone/Plate Accessory (p27)
- KE Cooling Device (required for temperatures over 70°C)
- PT-E Immersion Temperature Sensor
- Disposable Chambers

Water Jacket



Coaxial Cylinder Spindles



Double Gap Coaxial Cylinder for very low viscosity materials

MODEL	VISCOSITY RANGE (Pa•s)		SPEEDS
	Min.	Max.	RPM
RST-CC Coaxial Cylinder	.00005	5.41M	0.01-1.3K

See page 47 for individual bob/spindle ranges K = 1 thousand M = 1 million 1 Pa•s = 1000 cP (centipoise)

RST-SST Touch™ Rheometer

Soft Solids Tester for pastes, slurries and materials with particulates

Spindle Barcode

for auto spindle recognition

Measured Values

- Yield Stress
- Shear Modulus
- Recovery
- Creep

Optional Rheo3000 Software

allows for PC control and data acquisition/analysis of multiple test files

Quantifies meaningful properties

like stiffness, wobbliness, sloppiness, consistency and texture

Capable of measurements

in BU units for viscous materials such as joint compound

Vane Spindle Geometry

- Quick-Connect coupling
- Rapid spindle insertion without compromising sample structure
- Quick and easy test method

Coaxial Cylinders

can also be used for complete flow curve analysis

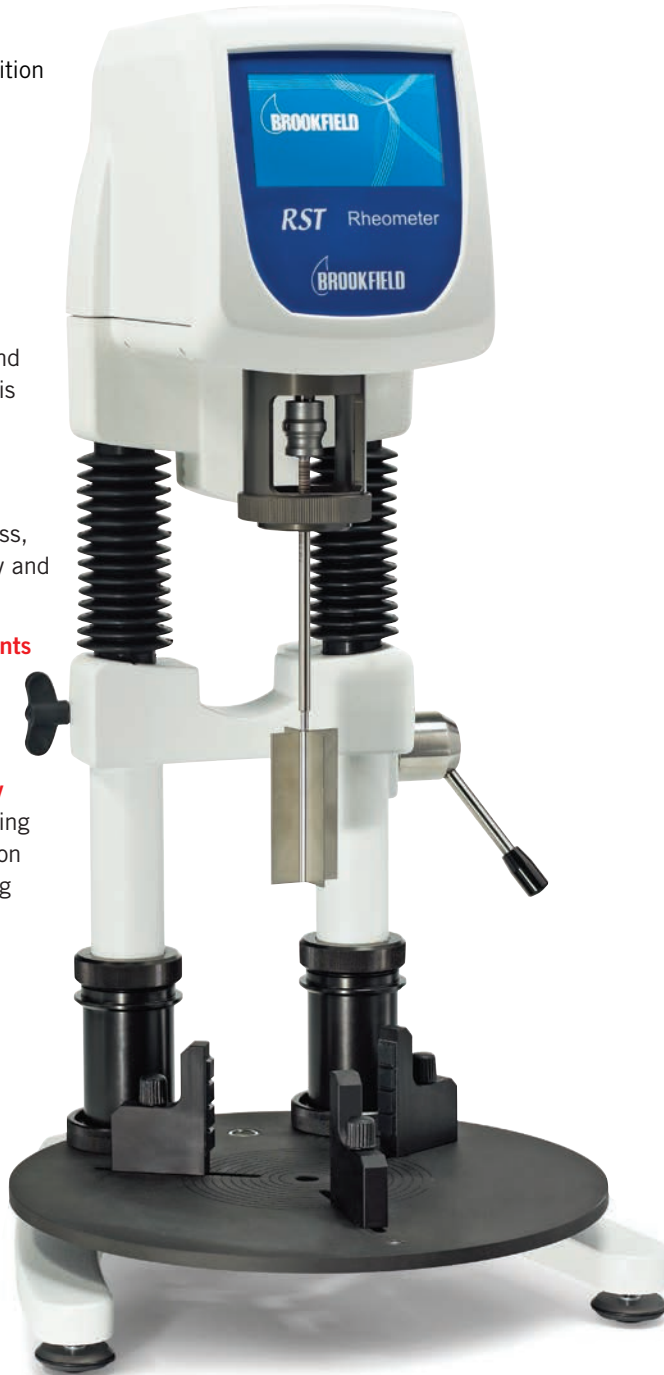

What's Included?

Instrument with base plate for sample placement and adjustable height control for rheometer head

Convenience Package (Cleaning Cloth, Screen Protector)

Optional Accessories

Choice of Spindle Geometries at least one is required:

- Vane (spindle) or RST-90Y
- Coaxial Cylinder Bob (spindle) & Chamber

Rheo3000 Software (p29)

Viscosity Standards (p53)

Cone/Plate Accessory (p27)

Thermosel System with Din 81 Spindle (p36-37)

PT-E Immersion Temperature Sensor



Choice of several vane spindle options



RST-90Y Spindle for BU measurements on joint compound and similar materials



Cone/Plate Accessory provides extended range capability for shear rate and viscosity

SHEAR STRESS (Pa)

MODEL	Min.	Max.
RST-SST Soft Solids Tester	0.2	218K

See pg. 47 for individual bob and vane spindle ranges K = 1 thousand Pa = Pascal

RST-CC & RST-SST Option Guide

choosing the correct spindles, chambers and other accessories for your application

Options for the RST-CC

Every Coaxial Cylinder system consists of the instrument, spindle and chamber. In order to assist with configuring an appropriate system, the following questions should be asked.

WHAT VISCOSITY RANGE DO YOU INTEND TO MEASURE?

Knowing the viscosity range will assist with selecting the most appropriate spindle geometry for your application.

RST Spindles		Refer to chart on page 47				
SPINDLE	VISCOSITY RANGE					
COAXIAL	Pa•s	Spindles				
		SPINDLE	VISCOSITY RANGE	SHEAR RATE	MAX. SHEAR STRESS	SAMPLE VOLUME
		mm	Pa•s	sec ⁻¹	Pa	ml
CCT-DG	0.00005-4.07K	1-DG	0.00005-4.07K	0.043-5.64K	177	15.7
CCT-40	0.0003-27.6K	40	0.0003-27.6K	79K	594	68.5
CCT-25	0.002-17K	25	0.002-17K	87K	2,28K	16.8
CCT-14	0.012-1M	14	0.012-1M	1,68K	13K	3.4
CCT-8	0.065-5.41M	8	0.065-5.41M	0.013-1.672K	69.6K	1.0
		25-1	0.005-407K	0.06-7.8K	24.4K	0.1
		CCT-25-2	0.01-814K	0.03-3.9K	24.4K	0.2
		RCT-50-1	0.0005-50.9K	0.06-7.8K	3.05K	1.0
		RCT-50-2	0.0012-101K	0.03-3.9K	3.05K	2.0

EXAMPLE: CCT-25

HOW WILL YOU BE CONTROLLING TEMPERATURE?



MBT-25 & CCT-25

Stand-alone Chamber:

For viscosity testing at room temperature or direct immersion in temperature bath. Chamber must match the spindle.

CCT-25 Spindle:

For use with the MBT-25 chamber.



FTKY3 & MBT-25F

FTKY3 Water Jacket with chamber:

For temperature control of sample using circulating bath. MBT-25F Chamber inserts inside water jacket.

Use with CCT-25 Spindle:

Shown above.

DO YOU NEED THE DISPOSABLE CHAMBER OPTION?

Working with messy or sticky materials can be simplified by using disposable chambers. Contact AMETEK Brookfield for details.

Options for the RST-SST

Every Soft Solids Tester can be used with coaxial cylinder geometries as well as with vane spindles. If using coaxial geometries, the same questions as in the prior section should be asked. The use of vane geometries does bring up additional considerations.

WHAT SHEAR STRESS RANGE IS APPROPRIATE FOR YOUR MATERIAL?

RST Vane Spindles		Refer to chart on page 47	
SPINDLE	VANE LENGTH		
	mm	VANE DIAMETER	SHEAR STRESS
		mm	Pa
VT-10-5	10	5	330-210K
		10	41-27K
VT-20-10	20	20	9-5.9K
		15	1.2-0.8K
VT-20-20	20	20	5.2-3.4K
		40	0.2-1.2K
VT-30-15	30	25	2.7-1.7K
		8	24-15K
VT-40-20	40	15	7-4.3K
		30	1.6-1K
		40	0.7-420
		70	0.2-120
VT-80-40	80		
VT-80-70	80		

Values based on minimum speed of 1 RPM and maximum speed of 1000 RPM. K = 1 thousand

EXAMPLE: VT-40-20 vane length = 40mm / width = 20mm

WHAT SAMPLE CONTAINER IS TO BE USED?



Container

For stand-alone testing you can use a beaker, your actual product container or any appropriately sized receptacle. Container size will impact shear rate.*

VT-40-20 Spindle:

Standard vane spindles have a long shaft.



*Our system assumes a container to Vane diameter ratio of 3 to 1 for a shear rate factor of 0.2355 sec⁻¹/rpm



MBT-25F or MBT-25

MBT-25F or MBT-25 Chamber:

Chamber may be used alone or with a water jacket and circulating bath.

VT-40-20MB Spindle:

Vane spindles with "MB" have a shorter shaft length to fit into coaxial chambers.



Rheo3000 Software

for quick and comprehensive data analysis capabilities with RST series Rheometers

Enhance your productivity

VIA PC CONTROL WHEN CHARACTERIZING MATERIAL RHEOLOGY

Your PC can do the detailed data collection and analysis work for you. Rheo3000 allows you to program the RST Rheometer and control shear stress or shear rate. Data is saved in a SQL database for easy access by multiple users on a network. Use multiple step test programs for complete characterization of material flow behavior: viscoelastic modulus, yield stress, viscosity flow curve, creep behavior, recovery. In addition, Rheo3000 provides automated analysis of fluid behavior against user-defined control limit values, resulting in better quality control. Mathematical data processing models included are: Newton, Bingham, Casson, Ostwald, Steiger-Ory, and Herschel-Bulkley. Helpful features include:

- 21 CFR compliance option for controlled user access and data security
- Active clock on screen shows test progress to completion
- Export reports in pdf format; choose parameters of interest, discard others

PC Requirements

- 1.5 GHz Processor
- 1 GB System Memory
- 2.5 GB Hard Drive
- VGA Graphics Adapter (800 x 600 resolution)
- 1 USB port

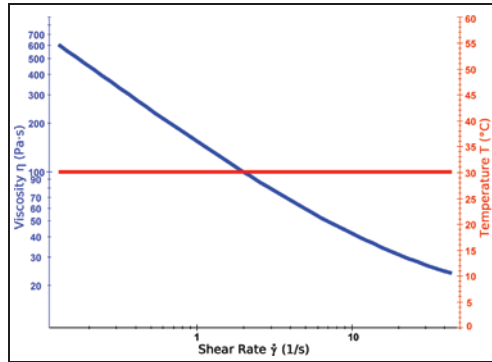

Viscosity Flow Curve: viscosity vs. shear rate graph shows pseudoplastic behavior while temperature remains constant at 30°C.

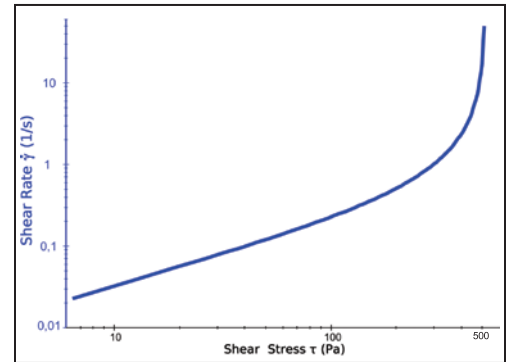

Yield Stress Determination: shear stress ramp from 0 to 1,000 Pa over 2 minutes shows yield stress values at 500 Pa.

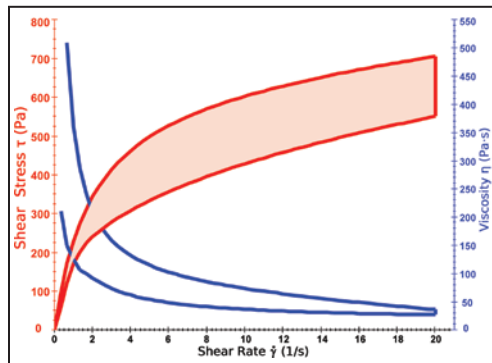

Thixotropy Analysis: up/down shear rate ramp produces curves for shear stress vs. shear rate (red color) and viscosity vs. shear rate (blue color). Thixotropy calculation is the area between the red curves, approximately 2,000 Pa•s.

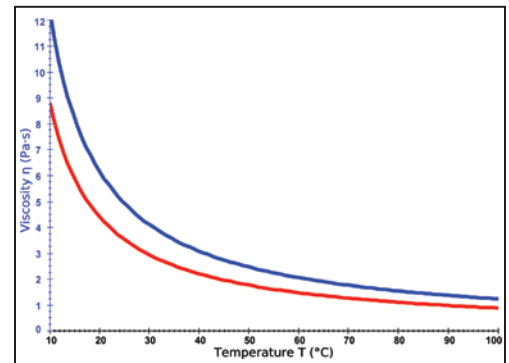

Viscosity vs. Temperature: viscosity is measured at constant shear rate while temperature increases from 10°C to 100°C for two test samples.

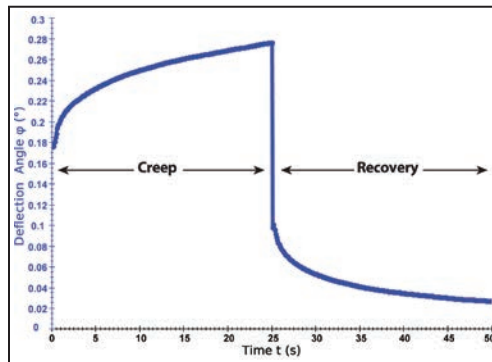

Creep /Recovery Behavior: material flow under constant stress is measured by detecting angular rotation of spindle; when constant stress is removed, recovery is measured by backward rotation of spindle.

PVS™ Rheometer

1' x 1' x 2' instrument for portable site-to-site mobility

Robust Motor

capable of speeds up to 1000 rpm

Quick and easy setup

in minutes

Safety Relief Valve

1000 psi (high pressure)

Avoids sample boil-off

Couette Geometry

Outside Cylinder Rotates, "bob" inside remains stationary, generating shear rates up to 1700 sec⁻¹

RTD on the inner cylinder

insures accurate sample temperature measurement

Test to industry standards

Vacuum to high pressure

measurements up to 1,000 psi

Hastelloy C cup and bobs

for operation in severe field environments

Low Shear Rate Viscosity (LSRV)

measurement to .02 sec⁻¹

Fluid Temperature conditions:

from -40°C to +260°C



What's Included?

- Instrument
- Choice of spindle (bob) (p31)
- Sample Cup
- RheoVision software ▶
- Carrying Case ▶

Optional Accessories

- Viscosity Standards (p52)
 - Additional spindle (bobs) (p31)
 - Computer
 - Temperature Control Bath
 - Thermo Bath (p31)
- Available with triple annulus geometry for increased sensitivity when measuring low viscosity fluids



MODEL	VISCOSITY RANGE cP(mPa•s)		SPEEDS	
	Min.	Max.	RPM	Number of Increments
PVS	.5	36M	.05-1K	10K

* Ranges depend on "Bob" spindle selected.
M = 1 million K = 1 thousand cP = Centipoise mPa•s = Millipascal•seconds

RheoVision® Software Included

FOR AUTOMATION AND CONTROL OF ALL TEST PARAMETERS

Specifically designed for sophisticated rheological analysis, RheoVision makes viscosity measurement under pressurized and temperature controlled conditions an easy task. Powerful scripting language provides simple to complex data collection programs including automatic calculation of yield stress using Bingham, Herschel-Bulkley, and Power Law equations.

- USB and RS232 connectivity
- Multiple PVS units to PC communication controls.
- Enhanced graphing capabilities
- Easy calibration checks with auto-calculation of the torque multiplier and built-in linearity check
- Use of a powerful Microsoft SQL database allows users to
 - Define product, fluids, customer, location and other specific parameters for samples and later search data on these same fields
 - Search tests by parameters and allow data and test parameters to link for easier full profile viewing
- Instantaneous flow curves
- Built in math modeling
- User-friendly ramp wizard for quick API testing
- Seal history tracking feature

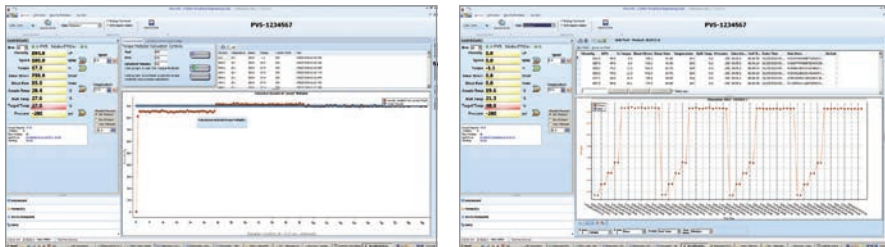

Applications

Fracturing Fluids
Petroleum Products

Drilling Muds
Black Liquor

Volatile Chemicals

PVS Spindles, Chambers and Rheometer Ranges

BOB/STATOR SAMPLE CUP	VISCOSITY RANGE cP(mPa·s)	SHEAR RATE (sec ⁻¹)	SAMPLE VOLUME (mL)*
PVS-B1-D-HC	2-5M	1.70N	23
PVS-B2-D-HC	20-36M	0.38N	40
PVS-B5-D-HC	5-10M	0.85N	30
PVS-TA5B5-D-HC	.5-1M	0.85N	175
CHAMBER			
PVS-30 (standard)	for use with B1, B2 or B5 spindle		
Triple Annulus	for use with PVS - TA5 B5 - D - HC		

*±1mL HC = Hastelloy C M = 1 million N = RPM mL = Milliliter



Thermo Bath option with PID Enhanced Control Capability

For sample heating with small space requirement. Call for details.



Carrying Case

For portability in the field.



PVS CHAMBER

PVS SPINDLE

BF35™ Viscometer

measures viscosity of oil drilling and fracturing fluids at atmospheric pressure in both field and laboratory settings

Easy speed changes
with convenient
control knob

**Conventional oilfield rotor,
bob and torsion spring**
maintain rheology history
and reproducibility between
instruments and laboratories

Adjustable table height
to accommodate a variety of
beaker/containment sizes



What's Included?

- Instrument
- Choice of bob Spindle
- Sample Cup

Shear Stress Values Displayed
on easy-to-read lighted magnified dial

Maintains a constant shear rate
under varying input power and
drilling fluid conditions. Provides
drilling fluid engineers with an
accurate and versatile tool.

Sample Cup

Specifications/Features

Motor Speeds:	8 fixed (3, 6, 30, 60, 100, 200, 300, 600)
Min. Viscosity:	0.5 cP (@600 rpm)
Max. Viscosity:	10,000,000 (@0.01 rpm)
Speed Accuracy:	0.001 (rpm)
Readout:	Direct dial with light
Heat Cup:	Stainless steel, 150 Watt, 190°F (88°C) maximum recommended temperature
Geometry:	True Couette Coaxial Cylinder
Power:	97-250 VAC, 50/60 Hz (12 volt operation requires special cable)
Carrying Case	Included

Temperature Control with Baths

Temperature Bath Systems combine state-of-the-art controller displays with high performance circulating baths to give accurate viscosity test results

All controllers are swivel-mounted so that user can adjust position for optimum viewing angle



AP Series Controllers

- Color touch-screen interface
- Standalone programmable or PC control with RheocalcT software
- Variable-speed pump
- Max. temperature up to 200°C
- Multiple languages (English, French, German, Spanish, Chinese available)
- Built-in help menu



SD Series Controllers

- Best value
- Programmable with PC control using RheocalcT software
- Quick scroll to set temperature in standalone mode
- 2-speed pump
- Maximum temperature up to 170°C



MX Series Controllers

- Economical
- Large character display
- Single-speed pump
- Maximum temperature up to 135°C

Step 1: Choosing the controller

CHOOSE THE ONE THAT BEST SUITS YOUR APPLICATION

- Choose the controller by considering factors such as the need for PC control using RheocalcT with DV2T or DV3T, ease of use, pump speed, and foreign language choices (AP series controller only).

Temperature Baths Features

MODEL	Temperature Range Low	Temperature Range High	Controller	Cooling	Temperature Stability†	Digital Type/Resolution (Set / Read)	Reservoir Capacity	Pump Speed	Maximum Flow Rate	Internal Work Area (inches)	Overall Dimensions (inches)	Weight (Gross)
TC-650AP	-20°C	+200°C	AP	Refrigerated	0.01°C	0.01 / 0.001	7.0 liters	Variable	16 LPM	6.18 x 5.59 x 5.0	21.3 x 8.7 x 24.3	90 lbs
TC-650SD	-20°C	+170°C	SD	Refrigerated	0.04°C	0.1 / 0.1	7.0 liters	2-speed	11 LPM	6.18 x 5.59 x 5.0	21.3 x 8.7 x 24.3	90 lbs
TC-650MX	-20°C	+135°C	MX	Refrigerated	0.07°C	0.1 / 0.1	7.0 liters	1-speed	12 LPM	6.18 x 5.59 x 5.0	21.3 x 8.7 x 25.4	84 lbs
TC-550AP	-20°C	+200°C	AP	Refrigerated	0.01°C	0.01 / 0.001	7.0 liters	Variable	16 LPM	6.18 x 5.59 x 5.0	23.2 x 16.2 x 16.2	90 lbs
TC-550SD	-20°C	+170°C	SD	Refrigerated	0.04°C	0.1 / 0.1	7.0 liters	2-speed	11 LPM	6.18 x 5.59 x 5.0	23.2 x 16.2 x 16.2	90 lbs
TC-550MX	-20°C	+135°C	MX	Refrigerated	0.07°C	0.1 / 0.1	7.0 liters	1-speed	12 LPM	6.18 x 5.59 x 5.0	23.2 x 16.2 x 17.3	84 lbs
TC-250AP*	ambient +10°C†	+150°C	AP	Tap Water	0.01°C	0.01 / 0.001	10.0 liters	Variable	16 LPM	5.0 x 11.0 x 6.0	13.9 x 13.5 x 14.9	45 lbs
TC-250SD*	ambient +10°C†	+150°C	SD	Tap Water	0.04°C	0.1 / 0.1	10.0 liters	2-speed	11 LPM	5.0 x 11.0 x 6.0	13.9 x 13.5 x 14.9	45 lbs
TC-250MX*	ambient +10°C†	+135°C	MX	Tap Water	0.07°C	0.1 / 0.1	10.0 liters	1-speed	12 LPM	5.0 x 11.0 x 6.0	13.9 x 13.5 x 16.0	39 lbs
TC-150AP*	ambient +10°C†	+150°C	AP	Tap Water	0.01°C	0.01 / 0.001	6.0 liters	Variable	16 LPM	4.5 x 4.0 x 6.0	13.4 x 8.1 x 14.9	26 lbs
TC-150SD*	ambient +10°C†	+150°C	SD	Tap Water	0.04°C	0.1 / 0.1	6.0 liters	2-speed	11 LPM	4.5 x 4.0 x 6.0	13.4 x 8.1 x 14.9	26 lbs
TC-150MX*	ambient +10°C†	+135°C	MX	Tap Water	0.07°C	0.1 / 0.1	6.0 liters	1-speed	12 LPM	4.5 x 4.0 x 6.0	13.4 x 8.1 x 16.0	20 lbs
TC-351	-20°C	N/A	N/A	N/A	N/A	N/A	N/A	N/A	N/A	N/A	14.0 x 14.0 x 14.0	72 lbs

* For use at lower temperatures, use the built-in tap water cooling, or use model TC-351 Cooler for control to -20°C.

† Low temperature limit 10°C above ambient unless external cooling is used.

‡ Temperature stability may vary depending on bath volume, surface area, insulation and type of fluid

N/A - Not Applicable
FOR OPERATING TEMPERATURES HIGHER THAN 80°C,
PLEASE CONTACT BROOKFIELD FOR BATH FLUID RECOMMENDATIONS.

Step 2: Choosing the bath

CHOOSE THE CIRCULATING BATH THAT MEETS YOUR NEEDS

Determine the type of circulating bath needed by considering temperature range, cooling requirements, reservoir capacity, flow speeds and built-in drains (Models TC-550 and TC-650). Consult the chart on page 33 for specifications.

TC-550

PC control capable
with RheocalcT software

Circulating Water Bath Refrigerated

- Most popular choice with widest temperature control capability
- Easily controls at 25°C for calibration checks
- 7-liter reservoir capacity
- Configured to measure viscosity directly in the bath or circulate to external water-jacketed devices**
- Accommodates one 600 mL beaker
- Provides stand-alone operation with no tap water required and easy control of set-point
- Available with MX, SD or AP Controllers
- Automated sample temperature control available with SD and AP Controllers

AP Controller shown



TC-650

PC control capable
with RheocalcT software

Circulating Water Bath Refrigerated

- Compact — small “footprint” on your lab bench or can be placed underneath lab bench
- Easily controls at 25°C for calibration checks
- 7-liter reservoir capacity
- Specifically designed for circulating to external water-jacketed devices**
- Accommodates one 600 mL beaker
- Provides stand-alone operation with no tap water required and easy control of set-point
- Available with MX, SD or AP Controllers
- Automated sample temperature control available with SD and AP Controllers

AP Controller shown



*Provided tap water temperature is 15°C or lower

**All baths can be used with AMETEK Brookfield water jacketed devices; Wells-Brookfield Cone/Plate Viscometer, R/S-CC and R/S-CPS Rheometers and Small Sample Adapter, Ultra-Low Adapter and DIN Adapter accessories

TC-150

Circulating Water Bath Non-Refrigerated

Compact – smallest “footprint” available
6-liter reservoir capacity

Removable deck lid accommodates
one 600 mL beaker to measure viscosity
directly in the bath

Tap water cooling coil for
temperature control at 25°C*

Built-in circulator pump for use
with external water-jacketed devices**

Available with MX, SD or AP Controller

MX Controller
shown



Water Bath Accessories

Algicide 8 oz.

TC-Fluid 1A

Keeps circulator baths clean,
odor free and resists black algae

50/50 Premix
Ethylene Glycol 1 gal.

TC-Fluid 2 -20°C to +100°C

Ethylene glycol 1:1 solution, ready to use

High Temperature Fluid 1 gal.

TC-Fluid 3 +50°C to +150°C

TC-Fluid 4 +100°C to +200°C

PVS-152 +25°C to +200°C

These heat transfer fluids provide superior
thermal stability

Low Temperature Fluid 1 gal.

TC-Fluid 5 -50°C to +58°C

Excellent low temperature performance

Little or no evaporation

Bath Cleaner 8 oz.

TC-Fluid 6A

Removes rust and mineral deposits

Concentrated liquid

18” Lab Stand Rod

VS-CRA-18S

Designed for increasing viscometer height
when measuring in a TC-150, TC-250 or
TC-550 Bath

TC-250

PC control capable
with RheocalT software

Circulating Water Bath Non-Refrigerated

Largest work area available
for conditioning multiple samples
directly in the bath

10-liter reservoir capacity

Accommodates 600 mL and
1000 mL beakers (cover is
removable for large sample
container requirements)

Built-in tap water cooling coil
for temperature control at 25°C*

Built-in circulator pump for use
with external water-jacket devices**

Available with MX, SD or AP Controller

SD Controller
shown



TC-351

Cooler (not shown) for use with TC-150 & TC-250 Circulating Baths

Eliminates tap water requirements on non-refrigerated baths

Increases lower range of most baths to -20°C



Accessories

Additional benches for elevating the
position of beakers, metal lids for
anchoring beakers, hoses depending on
temperature range, and deck lid covers are
available. Contact us for details.

Step 3: Comparing bath features

Once you've familiarized yourself with the AMETEK Brookfield Circulating Water Bath Series you can easily compare models to find the bath that best suits your requirements. Consult the chart on page 33 for all TC Series Model specifications.

Thermosel®

for Elevated Temperature Testing



Compatible with standard AMETEK Brookfield Viscometers and DV3T Rheometers
 Note: requires optional cable DVP-141

Provides control of sample temperature up to +300°C

EZ-Lock Option
 Thermosel is now available with special EZ-Lock spindle coupling for use on standard AMETEK Brookfield Viscometers/Rheometers already equipped with the EZ-Lock feature

Temperature Ramping between set points is possible if used with RheocalcT (DV3T & DV2T) Software
 Note: Requires optional cable HT-106

Thermo Container (Heating Chamber)

Computer Controlled when used with DV2T or DV3T and RheocalcT Software (HT-106 cable required)

Programmable Temperature Controller offers single set point or up to 10 programmable set points.

Direct Temperature Control Possible with DV2T/DV3T Rheometer (p20)



What's Included?

- Choice of one SC4 Spindle
Specify when ordering
- Alignment Bracket
- Thermo Container with safety guard and insulating cap
- 1 Removable Sample Chamber (p47)
- 5 Disposable Sample Chambers (p47)
Order additional chambers in quantities of 100, HT-2DB-100
- 18" Lab Stand Rod (p35)
- Extracting Tools
- Temperature Controller with an RTD probe

Applications

Hot Melts	Asphalt (ASTM D4402)
Wax	Polymers

The difficulty with viscosity measurements of hot melts and liquids at elevated temperatures has been in maintaining accurate temperature control that is consistent from sample to sample so that meaningful data could be obtained.

The AMETEK Brookfield Thermosel solves this problem by providing a stable, precisely controlled sample environment. This, together with the inherent accuracy of the AMETEK Brookfield Viscometers, is fundamental to the Thermosel System, which produces viscosity measurements that are not only accurate but entirely reproducible.

Several factors contribute to the stable environment:

- Non-fluctuating temperature control
- Small sample volume and insulated sample chamber which reduces temperature gradients within the sample
- The rotating spindle, which acts as a built-in stirring device
- The test procedure is quite straightforward. Once familiar with the system, unskilled operators can easily produce accurate, reproducible data.

Thermosel Viscosity Ranges cP(mPa•s)

SPINDLE SAMPLE VOLUME SHEAR RATE (sec ⁻¹)† MODEL	SC4-18 8mL 1.32N	SC4-31 10mL .34N	SC4-34 9.5mL .28N	SC4-21 8mL .93N	SC4-27* 10.5mL .34N	SC4-28 11.5mL .28N	SC4-29 13mL .25N	HT-DIN-81** 7mL 1.29N
DV3TLV	1.2-30K	12-300K	24-600K	Not applicable for historical reasons. However, it is possible to use the above spindles with any of these instruments.				1.0-10K
DV2TLV	1.5-30K	15-300K	30-600K					3.4-10K
DV1LV	3-10K	30-100K	60-200K	Digital Viscometers/Rheometers will automatically calculate viscosity. Please contact Brookfield or an authorized dealer if you require information on viscosity range.				3.4-10K
DVELV	3-10K	30-100K	60-200K					3.4-10K
LVT	5-10K	50-100K	100-200K					5.7-10K
DV3TRV				20-500K	100-2.5M	200-5M	400-10M	14.6-10K
DV2TRV				25-500K	125-2.5M	250-5M	500-10M	36.5-10K
DV1RV				50-170K	250-830K	500-1.7M	1K-3.3M	36.5-10K
DVERV	Not applicable for historical reasons.			50-170K	250-830K	500-1.7M	1K-3.3M	36.5-10K
RVT	However, it is possible to use the above spindles with any of these instruments.			50-100K	250-500K	500-1M	1K-2M	36.5-10K
DV3THA				40-1M	200-5M	400-10M	800-20M	29.2-10K
DV2THA	Digital Viscometers/Rheometers will automatically calculate viscosity. Please contact Ametek Brookfield or an authorized dealer if you require information on viscosity range.			50-1M	250-5M	500-10M	1K-20M	73.0-10K
DV1HA				100-300K	500-1.7M	1K-3.3M	2K-6.7M	73.0-10K
DVEHA				100-300K	500-1.7M	1K-3.3M	2K-6.7M	73.0-10K
HAT				100-200K	500-1M	1K-2M	2K-4M	73.0-10K
DV3THB				160-4M	800-20M	1.6K-40M	3.2K-80M	116.8-10K
DV2THB				200-4M	1K-20M	2K-40M	4K-80M	292.0-10K
DV1HB				400-1.3M	2K-6.7M	4K-13.3M	8K-26.7M	292.0-10K
DVEHB				400-1.3M	2K-6.7M	4K-13.3M	8K-26.7M	292.0-10K
HBT				400-800K	2K-4M	4K-8M	8K-16M	292.0-10K

M = 1 million K = 1 thousand N = RPM † Spindle SC4-18 1.32 x 10 (rpm) = 13.2 sec⁻¹ cP = Centipoise mPa•s = milliPascal•seconds

*Optional disposable SC4-27D spindle is available in quantities of 100, Part No. SC4-27D-100. Requires special chuck/closer, Part No. SC4-DSY, for attachment to viscometer.

**The 81 spindle, Part No. HT-DIN-81, works in an HT-2 or HT-2DB chamber.

Additional Information



Alignment Bracket ensures concentricity of spindle and sample chamber.



Other components supplied include sample chamber holder, RTD probe, insulating cap, coupling link, coupling nut and choice of SC4 spindle.



Extracting Tool enables the sample chamber to be handled easily and safely.



Option: Disposable Sample Chamber with Optional Disposable Spindle SC4-27D* is ideal for asphalts or any difficult-to-clean material.

Order disposable SC4-27D spindle in quantities of 100, Part No. SC4-27D-100.

Requires special chuck/closer, Part No. SC4-DSY, for attachment to viscometer.

Order disposable HT-2DB chambers in quantities of 100, Part No. HT-2DB-100.

Option: Solid shaft spindles for high viscosity materials (p47)

Small Sample Adapter™

for rheological evaluation where sample volume is limited

Standard Sample Chamber with embedded temperature probe provides direct temperature measurement of sample



Disposable Sample Chamber (Requires SSA-DCU Water Jacket)

Complete system shows the DV2T Viscometer and Small Sample Adapter with Circulating Water Bath for temperature control.



12.

What's Included?

1. Water Jacket
 2. Locating Channel Assembly
 3. Choice of one SC4 Spindle*
 4. Choice of one SC4 Sample Chamber*
 5. Insulating Cap
 6. Extension Link with Coupling Nut
- Storage Case (not shown)

*Specify when ordering

Optional Accessories

7. Embedded RTD temperature Probe in Chamber
 8. SC4-13RD-100 (100/box) Disposable Sample Chambers (p48) Requires special water jacket
 9. SC4-27D-100 (100/box) Disposable Spindles (p48)
 10. SSA-DCU Special Water Jacket and SC4-13RD Disposable Chambers (100/box)
 11. SSA27D-13RD-100 Includes SSA-DCU items (above) plus SC4-27D Disposable Spindles (100/box)
 12. Temperature Bath (p33-35)
 13. EZ-Lock Spindle Coupling (p50)
- For more info on Small Sample Adapter Accessory Kits visit our website.

The Small Sample Adapter provides a defined geometry system for accurate viscosity measurements at precise shear rates. Consisting of a cylindrical sample chamber and spindle, the Small Sample Adapter is designed to measure small sample volumes of 2 to 16 mL, and easily attaches to all standard AMETEK Brookfield Viscometers/ Rheometers.

Small Sample Adapter Viscosity Ranges cP(mPa•s)

MODEL	Spindle: SC4-18 Sample Chamber* SC4-13R(P) Sample Volume: 6.1mL Shear Rate (sec ⁻¹): 1.32N	Spindle: SC4-31 Sample Chamber* SC4-13R(P) Sample Volume: 9.0mL Shear Rate (sec ⁻¹): .34N	Spindle: SC4-34 Sample Chamber* SC4-13R(P) Sample Volume: 9.9mL Shear Rate (sec ⁻¹): .28N	Spindle: SC4-16 Sample Chamber* SC4-8R(P) Sample Volume: 4.2mL Shear Rate (sec ⁻¹): .28N	Spindle: SC4-23Z (316 s/s only) Sample Chamber* SC4-13R(P) Sample Volume: 16.1mL Shear Rate (sec ⁻¹): .22N	Spindle: SC4-21 Sample Chamber* SC4-13R(P) Sample Volume: 7.1mL Shear Rate (sec ⁻¹): .83N	Spindle: SC4-27(D) Sample Chamber* SC4-13R(P) Sample Volume: 10.4mL Shear Rate (sec ⁻¹): .34N	Spindle: SC4-15 Sample Chamber* SC4-7R(P) Sample Volume: 3.8mL Shear Rate (sec ⁻¹): .48N	Spindle: SC4-28 Sample Chamber* SC4-13R(P) Sample Volume: 11.0mL Shear Rate (sec ⁻¹): .28N	Spindle: SC4-29 Sample Chamber* SC4-13R(P) Sample Volume: 13.5mL Shear Rate (sec ⁻¹): .23N	Spindle: SC4-14 Sample Chamber* SC4-8R(P) Sample Volume: 2.1mL Shear Rate (sec ⁻¹): .40N
DV3TLV	1.2-30K	12-300K	24-600K	48-1.2M	192-4.8M	Not applicable for historical reasons. However, it is possible					
DV2TLV	1.5-30K	15-300K	30-600K	60-1.2M	240-4.8M	to use the above spindles with any of these instruments.					
DV1LV	3-10K	30-100K	60-200K	120-400K	800-1.6M	Digital Viscometers/Rheometers will automatically calculate					
DVELV	3-10K	30-100K	60-200K	120-400K	800-1.6M	viscosity. Please contact Brookfield or an authorized dealer					
LVT	5-10K	50-100K	100-200K	200-400K	800-1.6M	if you require information on viscosity range.					
DV3TRV						20-500K	100-2.5M	200-5M	200-5M	400-10M	500-12.5M
DV2TRV						25-500K	125-2.5M	250-5M	250-5M	500-10M	625-12.5M
DV1RV						50-170K	250-830K	500-1.7M	500-1.7M	1K-3.3M	1.25K-4.2M
DVERV		Not applicable for historical reasons.				50-170K	250-830K	500-1.7M	500-1.7M	1K-3.3M	1.25K-4.2M
RVT		However, it is possible to use the above spindles with any of these instruments.				50-100K	250-500K	500-1M	500-1M	1K-2M	1.25K-2.5M
DV3THA		Digital Viscometers/Rheometers will				40-1M	200-5M	400-10M	400-10M	800-20M	1K-25M
DV2THA		automatically calculate viscosity. Please				50-1M	250-5M	500-10M	500-10M	1K-20M	1.25K-25M
DV1HA		contact Ametek Brookfield or an authorized dealer				100-300K	500-1.7M	1K-3.3M	1K-3.3M	2K-6.7M	2.5K-8.3M
DVEHA		if you require information on viscosity range.				100-300K	500-1.7M	1K-3.3M	1K-3.3M	2K-6.7M	2.5K-8.3M
HAT						100-200K	500-1M	1K-2M	1K-2M	2K-4M	2.5K-5M
DV3THB						160-4M	800-20M	1.6K-40M	1.6K-40M	3.2K-80M	4K-100M
DV2THB						200-4M	1K-20M	2K-40M	2K-40M	4K-80M	5K-100M
DV1HB						400-1.3M	2K-6.7M	4K-13.3M	4K-13.3M	8K-26.7M	10K-33.3M
DVEHB						400-1.3M	2K-6.7M	4K-13.3M	4K-13.3M	8K-26.7M	10K-33.3M
HBT						400-800K	2K-4M	4K-8M	4K-8M	8K-16M	10K-20M

M = 1 million K = 1 thousand N = RPM e.g. Spindle SC4-18 1.32 x 10 (rpm) = 13.2 sec⁻¹ cP = Centipoise mPa•s = Millipascal-seconds

N/A = Not applicable for historical reasons. However, it is possible to use any spindle/chamber combination with any torque range. Digital viscometers/rheometers will automatically calculate viscosity.

* Examples

SC4-13R Sample Chamber

SC4-13RPY Sample Chamber with RTD temperature probe and cable to viscometer/rheometer

SC4-27 Stainless Steel Spindle

† Disposable chamber available in 13R size and requires SC4-45YD water jacket

SC4-13RP Sample Chamber with RTD temperature probe

SC4-13RD-100 Disposable Sample Chamber available in packages of 100

SC4-27D Disposable Spindle

Note: Hastelloy C available for some spindles/chambers - call for details

Removable Sample Chamber

The design of the Small Sample Adapter allows the sample chamber to be easily changed and cleaned without disturbing the set-up of the viscometer or temperature bath. This means that successive measurements can be made under identical conditions.

Temperature Control

The sample chamber fits into a water jacket so that precise temperature control can be achieved when the AMETEK Brookfield circulating temperature bath is used. The stirring action of the rotating spindle, plus the small sample volume, reduces waiting time to achieve thermal equilibrium. Direct readout of sample temperature is provided using sample chambers with optional embedded RTD sensor connected to the DV1 and DV2T Viscometers and the DV3T Rheometer. Working temperature range for the Small Sample Adapter is from 1°C to 100°C.

Cylindrical Geometry

The Small Sample Adapter's coaxial cylinder geometry provides extremely accurate viscosity measurements at defined shear rates. Option: Solid shaft (p48)

Disposable Sample Chambers and SC4-27D Spindle

Disposable 13R chambers, for hard-to-clean materials, are available in a kit that comes complete with 100 chambers and special-sized water jacket (Part No. SSA-DCU). Additional disposable chambers can be purchased in quantities of 100 (Part No. SC4-13RD-100).

EZ-Lock Option

Small Sample Adapter is now available with special EZ-Lock spindle coupling for use on standard Viscometers/Rheometers already equipped with the EZ-Lock feature.



Water jacket allows rapid and precise temperature control of sample

Sample chamber easily changed - slides into water jacket and locks in place

Simultaneous sample temperature measurement is possible by ordering embedded temperature probe in sample chamber

Optional disposable chamber also available

Enhanced UL Adapter™

ideal for low viscosity materials

Reduces measuring range

to as low as 1 cP, depending on viscometer used

Simple attachment

to a standard AMETEK Brookfield Viscometer or DV3T Rheometer

Small sample size:

16 mL

Cylindrical geometry

provides defined shear rates for detailed product analysis

Removable cap

of low density polyethylene can be considered disposable for one-time use if required

Stainless steel parts

are easily cleaned



What's Included?

Locating Channel Assembly
Spindle (304 s/s) (p46)
with universal coupling nut
Collar assembly with thumbwheel
Water Jacket
Chamber Tube
Tube End Caps (package of 6)

Optional Accessories

Available with EZ-Lock spindle coupling (p50)



Closed Tube and Spindle
made from 316 s/s

The AMETEK Brookfield Enhanced UL Adapter is used with any standard AMETEK Brookfield Viscometer and Rheometer to make accurate and reproducible measurements on low viscosity materials. Newtonian and non-Newtonian materials can be measured. It is most commonly used with the LV series instrument (at 60 rpm, these models have a full scale range of 1-10 cP with the UL Adapter). The UL Adapter consists of a precision cylindrical spindle rotating inside an accurately machined tube. Its rheologically correct cylindrical geometry provides extremely accurate viscosity measurements and shear rate determinations.

The tube has a removable end cap which allows the open ended tube to be used in a beaker or tank. With the cap in place, the closed tube can be immersed in a temperature bath or used with the ULA-40Y water jacket for precise temperature control. Working temperature range is from 1°C to 65°C. Use Closed Tubes for higher temperature requirements. The open tube is easier to clean.

Quick & Easy Design Saves Time



Quick & easy attachment of spindle:

Longer coupling nut for better grip and twist action to connect spindle to viscometer.

Redesigned bracket for attaching ULA assembly to viscometer. Provides more clearance for finger grip on coupling nut.



Quick & easy removal of chamber:

Simply loosen thumbwheel, chamber slides down and out.

Water jacket sleeve remains in place attached to viscometer while chamber and/or spindle only are removed. Saves set up time for the operator.



Detail of UL Adapter: 1. Locating Channel Assembly 2. Water Jacket 3. Chamber Tube 4. Collar with thumbwheel 5. Tube End Cap 6. Spindle with universal coupling

EZ-Lock Option

Enhanced UL Adapter is available with special EZ-Lock spindle coupling for use on standard AMETEK Brookfield Viscometers/Rheometers already equipped with the EZ-Lock feature. (p50)

Unique ULA Assembly Design Provides Multiple Benefits:

Sturdy collar attaches to locating channel assembly which is connected to viscometer pivot cup.

Sample chamber is held firmly in place by the collar which provides proper alignment for the spindle rotation within the chamber.

Universal coupling nut on spindle ensures firm connection with viscometer and automatic self-centering of spindle in chamber during rotation.

Direct immersion of chamber in temperature bath is quick and easy.

Water jacket grips slide over collar and operator manually aligns the collar/jacket assembly to allow easy insertion of chamber containing sample to be tested.

UL Adapter Ranges cP(mPa•s)

LVT, DVELV, DV1LV DV2TLV, DV3TLV	RVT, DVERV DV1RV	DV2TRV DV3TRV	HAT, DVEHA DV1HA	DV2THA DV3THA	HBT, DVEHB DV1HB	DV2THB DV3THB
1.0 - 2K	6.4 - 2K	3.0 - 2K	12.8 - 2K	6.0 - 2K	51.2 - 2K	24.0 - 2K

K = 1 thousand

Helipath Stand™

designed for measurement of non-flowing substances



For viscosity/consistency measurement of gels, pastes, creams, putty, gelatin and other non-flowing substances.

An AMETEK Brookfield Viscometer or Rheometer is mounted on the Helipath drive motor and a T-bar spindle is attached to the viscometer using a special coupling. The drive motor slowly lowers or raises the viscometer so that the T-bar spindle creates a helical path through the test sample thus eliminating the problem of “channeling”.

Compatible with standard AMETEK Brookfield Viscometers and DV3T Rheometers

Simple to set up and clean

Provides a solution for hard-to-measure materials

Complete with drive motor, 6 T-bar spindles with coupling, case, lab stand, rod and base

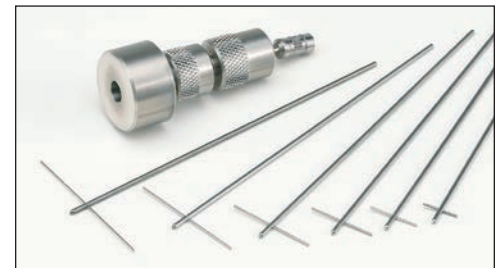

The Helipath Stand is supplied with a set of six T-bar spindles that attach to the instrument with a special coupling.

EZ-Lock Option

Helipath Stand is now available with special EZ-Lock spindle coupling for use on standard AMETEK Brookfield Viscometers/ Rheometers already equipped with the EZ-Lock feature. (p50)

Helipath Viscosity Ranges cP(mPa•s)

	DIAL, DVE, DV1	DV2T	DV3T
LV Viscosity Range	156 - 3.12M	156 - 9.36M	156 - 9.36M
RV Viscosity Range	2K - 20M	2K - 100M	2K - 100M
HA Viscosity Range	4K - 40M	4K - 200M	4K - 200M
HB Viscosity Range	16K - 160M	16K - 800M	16K - 800M

** Maximum range shown is at 0.1 rpm K = 1 thousand M = 1 million cP = Centipoise mPa•s = milliPascal•seconds

Vane Spindles

for foods, cosmetics, sealants...

...for use with paste-like materials, gels and fluids where suspended solids migrate away from the measurement surface of standard spindles.

Minimal disruption of sample during spindle immersion

Keeps particles in suspension during testing cycle

Viscosity data includes complete flow curve analysis when software is used

Provides information on yield behavior at low rotational speeds

Follows industry recommendations on length/diameter ratios for vane spindles

3-piece spindle set for versatile range capability

Optional V-74 and V-75 spindles for even greater range capability and immersion into small size sample containers



Vane Spindle Ranges

SPINDLE	TORQUE RANGE	SHEAR STRESS RANGE (Pa)	VISCOSITY RANGE cP(mPa*s)
V-71	NOT RECOMMENDED FOR USE ON LV TORQUE		
V-72	LV	.188-1.88	104.04-1.04K
V-73	LV	.938-9.38	502-5.02K
V-74	LV	9.38-93.8	5.09K-50.9K
V-75	LV	3.75-37.5	1.996K-19.96K
V-71	RV	.5-5	262-2.62K
V-72	RV	2-20	1.11K-11.1K
V-73	RV	10-100	5.35K-53.5K
V-74	RV	100-1K	54.3K-543K
V-75	RV	40-400	21.3K-213K
V-71	HA	1-10	524-5.24K
V-72	HA	4-40	2.22K-22.2K
V-73	HA	20-200	10.7K-107K
V-74	HA	200-2K	108.6K-1.086M
V-75	HA	80-800	42.6K-426K
V-71	HB	4-40	2.096K-20.96K
V-72	HB	16-160	8.88K-88.8K
V-73	HB	80-800	42.8K-428K
V-74	HB	800-8K	434.4K-4.344M
V-75	HB	320-3.2K	170.4K-1.704M
V-71	5xHB	20-200	10.48K-104.8K
V-72	5xHB	80-800	44.4K-444K
V-73	5xHB	400-4000	214K-2.14M
V-74	5xHB	4K-40K	2.172M-21.72M
V-75	5xHB	1.6K-16K	852K-8.52M



AMETEK Brookfield Vane Spindle Set

Includes V-71, V-72, and V-73 vane spindles. See the individual specifications in the spindle section. (p44)

Optional V-74 and V-75 spindles are smaller in size than V-73.

EZ-Lock Option

Vane Spindles are available with special EZ-Lock spindle coupling for use on standard AMETEK Brookfield Viscometers/ Rheometers already equipped with the EZ-Lock feature. (p50)

Note: 1. 1 Pa = 10 dyne/cm² 2. Viscosity Range is given at rotational speed of 10 RPM
3. 5xHB is the highest torque range available 4. Not for use with DV-E Viscometers

M = 1 million K = 1 thousand Pa = Pascal
cP = Centipoise mPa*s = Millipascal*seconds

DIN Adapter

Complies with DIN 53019 requirements for test geometry. DIN is the German equivalent to the U.S. ASTM Standards.

Designed to provide an alternative for those customers having limited sample volume. Requires 16 mL to 20 mL sample size.

Cylindrical geometry provides defined shear rates.

Comes with three spindles and chambers for measurement range of 1 to 50,000 cP.



DIN Adapter Set

EZ-Lock Option

DIN Spindles are available with special EZ-Lock spindle coupling for use on standard AMETEK Brookfield Viscometers/Rheometers already equipped with the EZ-Lock feature. (p50)

DIN Adapter Ranges cP(mPa•s)

LVT	LVDV-E DV1MLV	DV2TLV DV3TLV	RVT, RVDV-E DV1MRV	DV2TRV DV3TRV	HAT, HADV-E DV1MHA	DV2THA DV3THA	HBT, HBDV-E DV1MHB	DV2THB DV3THB
1.9 - 37.9K	1.2 - 37.9K	1.0 - 50K	12.2 - 50K	5.0 - 50K	24.4 - 50K	10.0 - 50K	97.6 - 50K	40.0 - 50K

K = 1 thousand cP = Centipoise mPa•s = Millipascal•seconds

Spiral Adapter

Designed for measuring the viscosity of heavy paste-like materials such as solder paste, cosmetics, pharmaceuticals, food products and other non-flowing products. Provides variable shear rates for detecting pseudoplastic and thixotropic behavior.

The spiral adapter is mounted onto a AMETEK Brookfield Viscometer; with the chamber immersed in the test sample and the motor turned on, material is “pumped thru” and reaches a steady flow rate. Shear rate is 0.677 sec⁻¹ per rpm.



Spiral Adapter Set

Compatible with standard AMETEK Brookfield Viscometers & DV3T Rheometers

Compatible with electronics industry solder paste specifications

Complete with chamber, two spindles, assembly clamp and case

Note: RV/HA/HB torque ranges recommended

Spiral Adapter Ranges cP(mPa•s)

LV Series	to 100K
RV Series	to 1.1M
HA Series	to 2.2M
HB Series	to 9.0M

K = 1 thousand M = 1 million cP = Centipoise mPa•s = milliPascal•seconds

Spindles

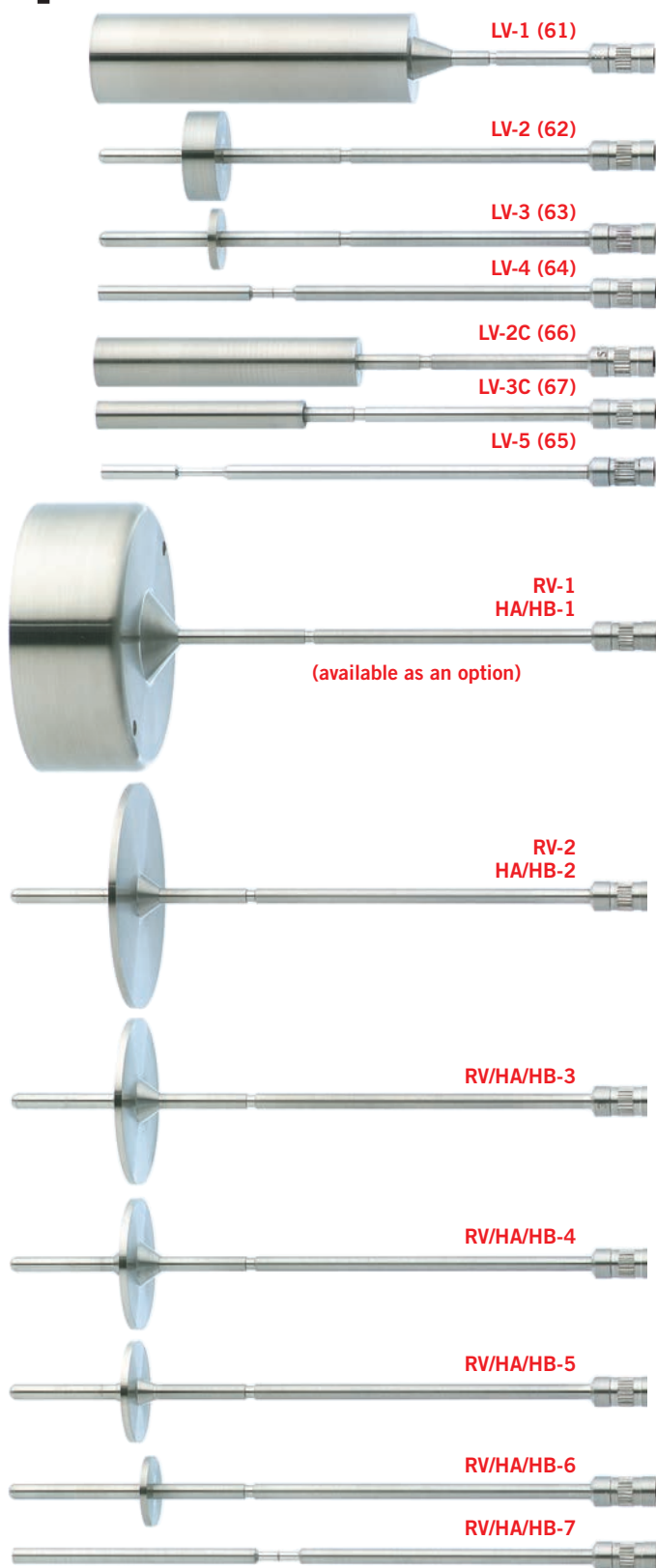

LV Spindles cP(mPa•s)	
SPINDLE	RANGE*
LV-1 (61)	15 - 20K
LV-2 (62)	50 - 100K
LV-3 (63)	200 - 400K
LV-4 (64)	1K - 2M
LV-5 (65)	2K - 4M
LV-2C	50 - 100K
LV-3C	200 - 400K

* Based on Standard LV speeds .3 - 60 rpm M = 1 million K = 1 thousand
 Note: LV-1 through LV-4 are supplied with LV instruments.
 LV-2C & LV-3C are optional "cylindrical spindles" offering geometry for calculating shear rates.
 LV and RV/HA/HB spindles are supplied in 302 stainless steel.
 Optional 316 stainless or teflon coated spindles are available

RV/HA/HB Spindles cP(mPa•s)			
SPINDLE	RANGE* RV SERIES	RANGE* HA SERIES	RANGE* HB SERIES
RV-1 **	100 - 20K	200 - 40K	800 - 160K
HA/HB-1 **	100 - 20K	200 - 40K	800 - 160K
RV-2	100 - 80K	200 - 160K	800 - 640K
HA/HB-2	100 - 80K	200 - 160K	800 - 640K
RV/HA/HB-3	100 - 200K	200 - 400K	800 - 1.6M
RV/HA/HB-4	200 - 400K	400 - 800K	1.6K - 3.2M
RV/HA/HB-5	400 - 800K	800 - 1.6M	3.2K - 6.4M
RV/HA/HB-6	1K - 2M	2K - 4M	8K - 16M
RV/HA/HB-7	4K - 8M	8K - 16M	32K - 64M

* Based on standard RV/HA/HB speeds .5-100 RPM. M = 1 million K = 1 thousand
 Note: LV and RV/HA/HB spindles are supplied in 302 stainless steel.
 Optional 316 stainless or teflon coated spindles are available
 ** This spindle available as an option



RV/HA/HB Spindle Set includes spindles #2 - #7 and is supplied with standard AMETEK Brookfield Viscometers and Rheometers.

Spindle #1 is available as an option.

Spindle Rack is also available as an option with both LV and RV/HA/HB spindle sets.

Spindles

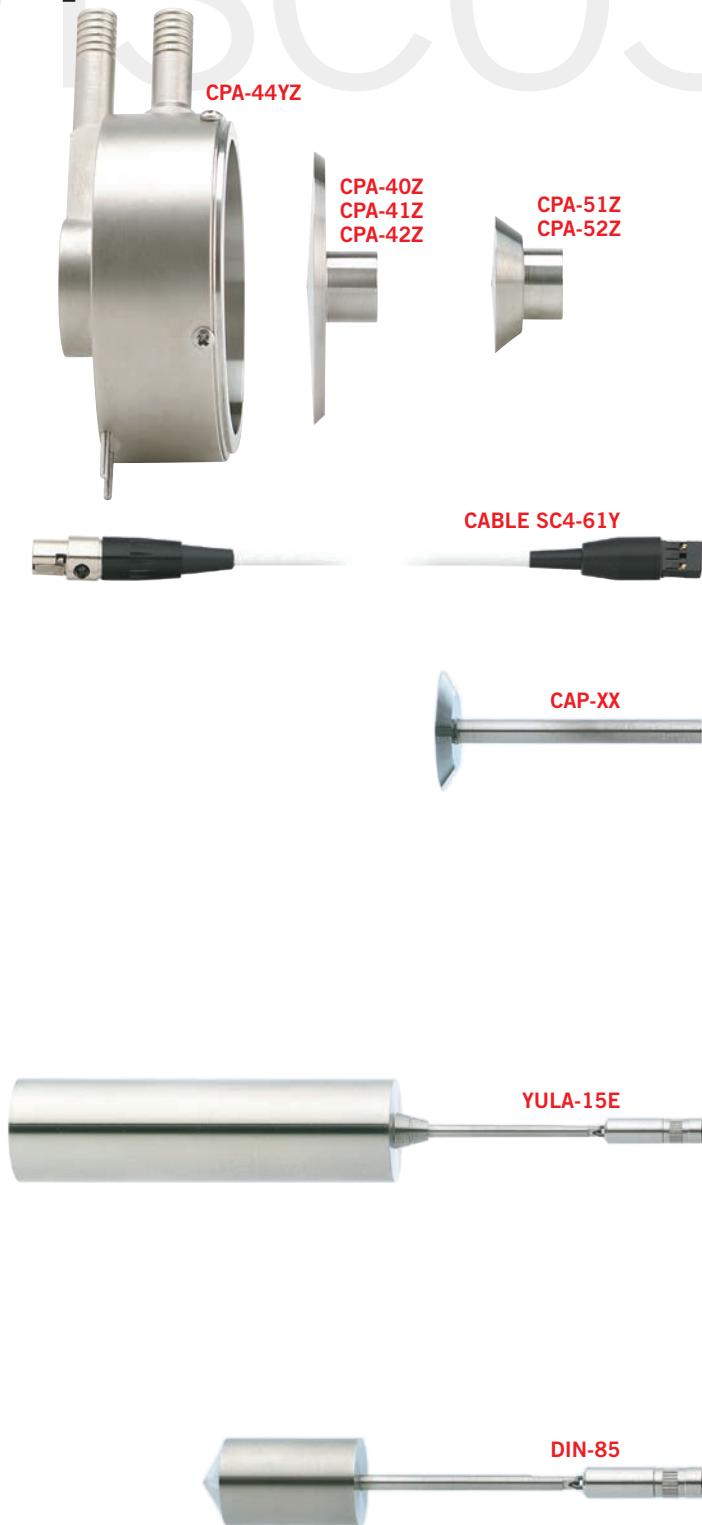

Wells/Brookfield Spindles & Cups				
SPINDLE	SHEAR RATE	SAMPLE VOLUME	CONE ANGLE	CONE RADIUS
CPA-40Z	7.50N sec ⁻¹	.5mL	.8°	2.4cm
CPA-41Z	2.00N sec ⁻¹	2.0mL	3°	2.4cm
CPA-42Z	3.84N sec ⁻¹	1.0mL	1.5°	2.4cm
CPA-51Z	3.84N sec ⁻¹	.5mL	1.5°	1.2cm
CPA-52Z	2.00N sec ⁻¹	.5mL	3°	1.2cm
CUP				
CPA-44YZ	Standard cup without temperature probe			
CPA-44PYZ	Standard cup with RTD temperature probe			
PCPA-3YZ	Cup with 1 purge fitting			
PCPA-6YZ	Cup with luer fitting and 1 purge fitting			
PCPA-4YZ	Cup with luer fitting and 2 purge fittings			
PCPA-7YZ	Cup with luer fitting and 4 purge fittings			

Note: 1. Wells-Brookfield cones and cups are calibrated at the factory.
 Cones ordered after shipment require cups to be returned for calibration to new cone.
 2. CPA cups and spindles are compatible with CPE cups and spindles
 3. See page 18 for viscosity ranges

CAP Spindles				
SPINDLE	SHEAR RATE	SAMPLE VOLUME	CONE ANGLE	CONE RADIUS
CAP-01	13.3N sec ⁻¹	67 µL	0.45°	1.511cm
CAP-02	13.3N sec ⁻¹	38 µL	0.45°	1.200cm
CAP-03	13.3N sec ⁻¹	24 µL	0.45°	0.953cm
CAP-04	3.3N sec ⁻¹	134 µL	1.8°	1.200cm
CAP-05	3.3N sec ⁻¹	67 µL	1.8°	0.953cm
CAP-06	3.3N sec ⁻¹	30 µL	1.8°	0.702cm
CAP-07	2.0N sec ⁻¹	1700 µL	3.0°	2.399cm
CAP-08	2.0N sec ⁻¹	400 µL	3.0°	1.511cm
CAP-09	2.0N sec ⁻¹	100 µL	3.0°	0.953cm
CAP-10	5.0N sec ⁻¹	170 µL	1.2°	1.511cm

Note: 1. Recommend ordering calibration fluids specific to cone for field calibration
 2. See page 21 for viscosity ranges

UL Spindles & Chambers			
SPINDLE	TYPE	SAMPLE VOLUME	SHEAR RATE
YULA-15(E)	Spindle - 304 stainless steel		1.224N
YULA-15(E)Z	Spindle - 316 stainless steel		1.224N
ULA-31(E)Y	Sample Chamber - 304 stainless steel	16mL	
ULA-31(E)YZ	Sample Chamber - 316 stainless steel	16mL	

Note: 1. See page 41 for viscosity ranges
 2. (E) represents enhanced UL version (introduced Jan. 2006) N = rpm

DIN Spindles		
SPINDLE	SHEAR RATE	SAMPLE VOLUME
ULA-DIN-85	1.29N	17.0mL
ULA-DIN-86	1.29N	6.5mL
ULA-DIN-87	1.29N	2.0mL
HT-DIN-81 for Thermosel	1.29N	7.0mL
SC4-DIN-82 for SSA	1.29N	1.5mL
SC4-DIN-83 for SSA	1.29N	1.5mL
CHAMBER		
ULA-DIN-6Y	for use with ULA-DIN-86 and 87	
DAA-1	for use with ULA-DIN-85	



CCT-XX



RCT-XX-X



VT-80-40



RSS-90Y (1-4000BU)



SC4-XXBS SOLID SHAFT*



SC4-XX LINK HANGING



HT-2



HT-2DB-100



CHAMBER RACK HT-54

Call or visit our website for more information on spindles with EZ-Lock connectors.

RST Spindles

SPINDLE	VISCOSITY RANGE	SHEAR RATE	MAX. SHEAR STRESS	SAMPLE VOLUME
COAXIAL	Pa*s	sec ⁻¹	Pa	mL
CCT-DG	0.00005-4.07K	0.043-5.64K	177	15.7
CCT-40	0.0003-27.6K	0.0215-2.79K	594	68.5
CCT-25	0.002-177K	0.013-1.67K	2.28K	16.8
CCT-14	0.012-1M	0.013-1.68K	13K	3.4
CCT-8	0.065-5.41M	0.013-1.672K	69.6K	1.0
CONE				
RCT-25-1	0.005-407K	0.06-7.8K	24.4K	0.1
RCT-25-2	0.01-814K	0.03-3.9K	24.4K	0.2
RCT-50-1	0.0006-50.9K	0.06-7.8K	3.05K	1.0
RCT-50-2	0.0012-101K	0.03-3.9K	3.05K	2.0
RCT-75-1*	0.0002-15K	0.06-7.8K	905	2.5
RCT-75-2*	0.0004-30K	0.03-3.9K	905	5.0
PLATE				
RPT-25	0.03-2.49M	0.013-1.7K	32.6K	0.5
RPT-50	0.002-155K	0.027-3.4K	4.07K	2.0
RPT-75*	0.0004-30.7K	0.04-5.1K	1.2K	4.5

*For use with water bath version only 1 Pa*s = 1,000 cP K = 1 thousand M = 1 million
Note: Values based on minimum speed of 1 RPM and maximum speed of 1000 RPM

RST Vane Spindles

SPINDLE	VANE LENGTH	VANE DIAMETER	SHEAR STRESS
	mm	mm	Pa
VT-10-5	10	5	330-210K
VT-20-10	20	10	41-27K
VT-20-20	20	20	9-5.9K
VT-30-15	30	15	12-8K
VT-40-20	40	20	5.2-3.4K
VT-40-40	40	40	1.2-740
VT-50-25	50	25	2.7-1.7K
VT-60-8	60	8	24-15K
VT-60-15	60	15	7-4.3K
VT-60-30	60	30	1.6-1K
VT-80-40	80	40	0.7-420
VT-80-70	80	70	0.2-120

Values based on minimum speed of 1 RPM and maximum speed of 1000 RPM K = 1 thousand

Thermosel Spindles and Chambers

Link hanging configuration is standard

SPINDLE	SHEAR RATE	SAMPLE VOLUME
SC4-18	1.32N	8.0mL
SC4-31	.34N	10.0mL
SC4-34	.28N	9.5mL
SC4-21	.93N	8.0mL
SC4-27**	.34N	10.5mL
SC4-28	.28N	11.5mL
SC4-29	.25N	13.0mL
HT-DIN-81	1.29N	7.0mL

*SC4-XXBS = Solid Shaft. Not available for SC4-18 and SC4-21 spindles
**Also available as SC4-27D-100 = Disposable spindle, 100 units • SC4-DSY Chuck/Closer is required

CHAMBER	TYPE
HT-2	Sample Chamber - Reuseable, stainless steel
HT-2DB-100	Sample Chamber - Disposable, aluminum, 100 units

Note: See page 37 for spindle ranges

Spindles



SC4-27SD SOLID SHAFT†

SC4-27 LINK HANGING

Required for SC4-27D disposable spindles: SC4-DSY CHUCK/CLOSER



SC4-13RPY



SC4-13RD



KREBS SPINDLE KU-1030

PASTE SPINDLE KU-1031



T-BAR SPINDLE T-A THRU T-F

CHUCK/WEIGHT/CLOSER ASSEMBLY BTU-18Y



SPIRAL ADAPTER SPINDLE SA-70



V-71

Small Sample Spindles and Chambers

SPINDLE	SAMPLE CHAMBER	SHEAR RATE	SAMPLE VOLUME
SC4-18	13R	1.32N	6.7 mL
SC4-31	13R	0.34N	9.0 mL
SC4-34	13R	0.28N	9.4 mL
SC4-16	8R	0.29N	4.2 mL
SC4-25Z (316 s/s only)	13R	0.22N	16.1 mL
SC4-21†	13R	0.93N	7.1 mL
SC4-27*†	13R	0.34N	10.4 mL
SC4-15	7R	0.48N	3.8 mL
SC4-28	13R	0.28N	11.0 mL
SC4-29	13R	0.25N	13.5 mL
SC4-14	6R	0.40N	2.1 mL
SC4-DIN-82	13R	1.29N	1.5 mL
SC4-DIN-83	7R	1.29N	1.5 mL

CHAMBER	TYPE
SC4-13R	Sample Chamber w/o temperature probe
SC4-13RPY	Sample Chamber w/RTD temperature probe & cable
SC4-8R	Sample Chamber w/o temperature probe
SC4-8RPY	Sample Chamber w/RTD temperature probe & cable
SC4-7R	Sample Chamber w/o temperature probe
SC4-7RPY	Sample Chamber w/RTD temperature probe & cable
SC4-6R	Sample Chamber w/o temperature probe
SC4-6RPY	Sample Chamber w/RTD temperature probe & cable
SC4-13RD-100‡	Sample Chamber - Disposable, aluminum, 100 units

Note: See page 39 for spindle/chamber ranges ‡ Requires the use of special water jacket SC4-45YD
 * Also available as SC4-27D-100 = Disposable spindle, 100 units
 † Solid shaft option available for spindles SC4-21 (Part No. SC4-21SD) and SC4-27 (Part No. SC4-27SD).

KU-3 Spindles

SPINDLE	TYPE
KU-1030	Standard Krebs Spindle
KU-1031	Optional Paste Spindle

T-Bar Spindles cP(mPa•s)

SPINDLE	LV	RV	HA	HB
T-A	156 - 62.5K	2K - 400K	4K - 800K	16K - 3.2M
T-B	312 - 124.8K	4K - 800K	8K - 6M	24K - 6.4M
T-C	780 - 312K	10K - 2M	20K - 4M	80K - 16M
T-D	1.5K - 624K	20K - 4M	40K - 8M	160K - 32M
T-E	3.9K - 1.5M	50K - 10M	100K - 20M	400K - 80M
T-F	7.8K - 3.1M	100K - 20M	200K - 40M	800K - 160M

M = 1 million K = 1 thousand

Spiral Adapter Spindle

SPINDLE	CHAMBER
SA-70	SA-1Y

Note: See page 44 for ranges

Vane Spindles

SPINDLE	VANE LENGTH (in)	VANE DIAMETER (in)
V-71	2.708	1.354
V-72	1.706	.853
V-73	.998	.499
V-74	.463	.232
V-75	.632	.316

Note: Container diameter should be twice (2x) the vane diameter when possible. See page 43 for ranges.

Options & Specialty Items



MV1Y

MV1Y Flag Impeller Spindle

Use with the Small Sample Adapter to help keep sample materials in suspension



4B2

4B2 Spindle

Required for viscosity testing in accordance with ASTM D2983 (Low Temperature Viscosity Measurement of Automotive Fluid Lubricants)



ABZ

ABZ Spindle

Used for viscosity testing of thick film pastes. Short spindle length is suitable for immersion into shallow depth containers. Sensing length of spindle is less than 1-inch (2.54cm).

ABZ Spindle		
RV	HA	HB
8K-16M	16K-32M	64K-138M

Custom Spindles

Custom spindles can be developed to meet your particular test requirements. Contact AMETEK Brookfield or an authorized dealer for details.



SP1-UC-Y

YDX-1



SXL-X

SP1-UC-Y

SXR-X

Type D Extension Link with Hook Coupling	
YDX-1	Male coupling nut; attaches to spindle
SP1-UC-Y	Female coupling nut; attaches to viscometer
SXV-XX	Extension link; see below for lengths

Type S Spindle with one SP1-UC-Y coupling	
SPINDLE	
SXL-X	Type S LV spindle (1-4)
SXR-X	Type S RV/HA/HB spindle (1-7)



EXTENSION LINK SXV-XX

Extension		
LINK	LENGTH	USED WITH
SXV-08	1"	UL Adapter
SXV-09	1.12"	Small Sample Adapter
SXV-24	3"	Thermosel
SXV-32	4"	Type D/S Extension
SXV-48	6"	Type D/S Extension
SXV-80	10"	Type D/S Extension
SXV-96	12"	Type D/S Extension

Note: Other lengths available; call for details



SP-7Y QUICK CONNECT COUPLING

SP-4

SP-3

SP-5

Quick Connect Coupling (SP-7Y)	
PART	
SP-3	Coupling to viscometer/rheometer
SP-4	Coupling to spindle
SP-5	Sleeve (to hold together)

Call or visit our website for more information on spindles with EZ-Lock connectors.

Options & Specialty Items

Model A Lab Stand: Dial, DV-E

Model G Lab Stand: DV3T, DV2T, DV1

All standard viscometers are supplied with either a Model A or Model G Laboratory Stand. These traditional stands move the viscometer up and down by turning the knob on the 14 inch rod* and clamp assembly. The clamp itself has been newly redesigned to allow for an easier, more ergonomic grip.

*Lab Stands with 18 inch rod assemblies are also available for testing with baths. Part Numbers for 18" stands: Model A 18, Model G 18



Quick Action Lab Stand:

Optional purchase for Dial, DV-E, DV1, DV2T, DV3T



MODEL QB LAB STAND

Taking measurements has never been so fast or easy! With the push of a button, the instrument moves up and down the lab stand, quicker and easier than ever before. The Quick Action Lab Stand is perfect for busy lab environments, especially those with multiple operators or multiple samples. This stand is available as an option for new Dial, DV-E, and DV1 Viscometers and is also compatible with existing models.

EZ-Lock Spindle Coupling System



Quickly and more safely change spindles with this spring-loaded spindle coupling attachment. Attach the EZ-Lock Spindle Coupling to a spindle and insert the spindle into the chuck. That's it! Changing spindles has never been quicker or easier... making this the perfect option for busy labs with multiple samples to test. EZ-Lock can be purchased as an option for new DV1 and DV2T Viscometers as well as the DV3T Rheometer. It can also be retrofitted to your existing DV-I and DV-II series Viscometer as well as any of your DV-III series Rheometers.

EZ-Lock is also available for use with your favorite AMETEK Brookfield accessories such as the Thermosel and Helipath Stand as well as the following adapters: Small Sample Adapter, UL Adapter, Enhanced UL Adapter and DIN Adapter.*

* Special brackets may be required to accommodate the length of the EZ-Lock system; requirement can be determined at time of ordering.

Ball Bearing Option

If your viscometer or rheometer is used by multiple operators or in a busy lab environment, a more durable ball bearing suspension system may help keep your instrument in calibration longer with less "down time". This option can be ordered at the time of purchase and a retrofit to existing instruments may be available. Consult AMETEK Brookfield or your local AMETEK Brookfield representative for details.**

** This option is for the torque ranges of RV, HA, and HB only - it is not available for instruments in the LV torque range.

Protective Keypad Covers



Protect your keypad against dirt, scratches, spillage and dust with these “peel and stick” disposable covers. They are ideal for instruments with multiple users and for busy, high traffic work areas. These flexible protective covers are packaged in quantities of 10 and are available for most DV-I series, DV-II series, CAP series, DV-III series, VTE series and AST-300SY touch screen controller models.

Complimentary Torque Decals

Now you can quickly identify the torque range of your standard AMETEK Brookfield Viscometer/Rheometer with easy-to-read decals. The decals provide a convenient labeling system for your lab or production personnel. The label sheet comes with pressure-sensitive decals, two large and two small for LV, RV, HA and HB torque ranges. The small decals fit on the instrument faceplate and the large decals on the side, back or top of the instrument. Request Part Number T05-1012.



Dymo 450 Turbo Label Writer

Easily print — and permanently record — test data with this compact Dymo 450 turbo label writer for DV1M, DV2T Viscometers and DV3T Rheometers. It comes complete with three convenient continuous feed paper rolls:

Paper roll, 2 1/4" wide x 300' (Reorder: GV-1047)

Adhesive label roll, 1 1/8" x 3 1/2", 350 labels per roll (Reorder: GV-1048)

Adhesive label roll, 2 5/16" x 4", 300 labels per roll (Reorder: GV-1049)



Touch Screen Protectors

Easy to apply Touch Screen Protectors to shield against dust and dirt are now available for DV2T Viscometers (Part No. GV-1019) and DV3T Rheometers (Part No. GV-1020). Each package includes two touch screen protectors, an application tool for easy alignment, and a cleaning cloth. It's no-water-required application method ensures a no mess, smooth application.



The AMETEK Brookfield Website

Looking for more information? Then the AMETEK Brookfield website is the place to visit. Here you can download manuals, SDSs, article reprints, brochures and find representatives in your area. Find out when our popular training series will be in your area or watch our, free online videos. The website is updated frequently so there's always something new to discover at www.brookfieldengineering.com.

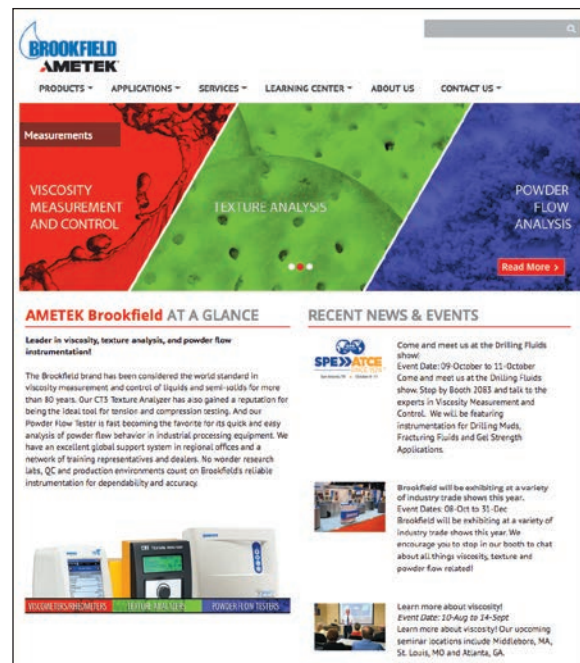

Viscosity Standards

AMETEK Brookfield Viscosity Standards provide a convenient, reliable way to verify the calibration of your AMETEK Brookfield Laboratory Viscometer/Rheometer. AMETEK Brookfield Viscosity

Standards are Newtonian and available as either silicone or oil. Silicone fluids are less temperature sensitive than oil fluids. Note: AMETEK Brookfield recommends that all fluids be replaced annually

Silicone Viscosity Standards

These fluids are most commonly used to verify calibration of AMETEK Brookfield Viscometers/Rheometers.

Accuracy: ±1% of viscosity value

Excellent temperature stability

Recommended for use with AMETEK Brookfield and most other rotational viscometers

Most economical

Special viscosity values and temperature calibrations available upon request



VisCal Kit

The VisCal Kit provides all the necessary items to verify calibration of your Viscometer/Rheometer. Includes AMETEK Brookfield 600mL Beaker, 1 pint of Silicone Viscosity Standard, Dispensing Bottle for cleanup and Trapper Cleaning Agent.*

*Trapper Cleaning Agent available only in shipments within the USA



Plastic VisCal Kit

The AMETEK Brookfield Plastic VisCal Kit provides all the necessary items to verify calibration of your Viscometer/Rheometer in a glass-free environment. Includes AMETEK Brookfield 600mL Plastic Beaker, 1000ml of Silicone Viscosity Standard (5-12,500 cP) in a plastic bottle and a AMETEK Brookfield-designed metal lid for anchoring beaker in the temperature bath.



General Purpose Silicone Fluids			
Brookfield Part #	Nominal Viscosity cP (mPa•s)	Temp °C	Temp °C
5 cps	5	20.0°C	25.0°C
10 cps	10	20.0°C	25.0°C
50 cps	50	20.0°C	25.0°C
100 cps	100	20.0°C	25.0°C
500 cps	500	20.0°C	25.0°C
1000 cps	1,000	20.0°C	25.0°C
5000 cps	5,000	20.0°C	25.0°C
12500 cps	12,500	20.0°C	25.0°C
30000 cps	30,000	20.0°C	25.0°C
60000 cps	60,000	20.0°C	25.0°C
100000cps	100,000	20.0°C	25.0°C

High Temperature Silicone Fluids			
Brookfield Part #	Nominal Viscosity cP (mPa•s)	Temp °C	Temp °F
HT30000	30,000	25.0°C	77°F
	9,000	93.3°C	200°F
	4,500	149.0°C	300°F
HT60000	60,000	25.0°C	77°F
	18,000	93.3°C	200°F
	9,000	149.0°C	300°F
HT100000	100,000	25.0°C	77°F
	30,000	93.3°C	200°F
	15,000	149.0°C	300°F

Special Order Silicone Fluids

For our customers needing a nonstandard viscosity or temperature range, our silicone fluids can be modified to meet most requirements.

VISCOSITY BLENDS CALIBRATED AT 25°C (77°F)

- Minimum: 5 cP (mPa•s)
- Maximum: 60,000 cP (mPa•s)
- Blends will be within ±2% of requested value

TEMPERATURE CALIBRATIONS

- Minimum: 10°C (50°F)
- Maximum: 80°C (176°F)
- Minimum temperature increment: 2°C

Oil Viscosity Standards

These fluids are used for specific instruments using cone/plate or Krebs spindle geometry. Also, certain industries may require use of oil standards.

Accuracy: ±1% of viscosity value

Appropriate for use at shear rates greater than 500 sec⁻¹

Recommended for use with cone/plate Viscometers at viscosities above 5,000 cP

Recommended for AMETEK Brookfield CAP series and KU-3 Viscometers and RST Rheometers

AMETEK Brookfield oil viscosity standards are hydro-carbon based, either mineral oil or polybutenes

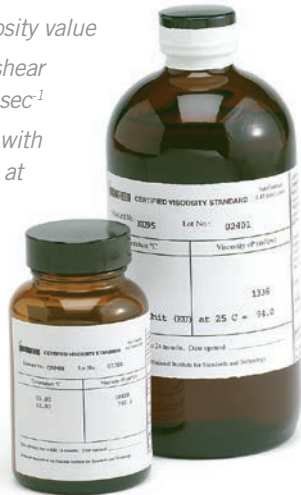

Note: Other oil fluids are available – call for details

AMETEK Brookfield Viscosity Standards are accurate to ±1% of the stated viscosity and are certified by methods traceable to the United States National Institute of Standards and Technology (NIST). The selection of one or two fluids will normally provide sufficient measurement points to verify calibration of your instrument. All fluids are supplied in 1/2 liter (1 pint) containers complete with a certificate of calibration. CAP Oil Fluids are supplied in 150 mL (4 oz) containers

CAP Viscometer Oil Fluids For calibrating CAP Series cones each spindle has its own fluid

Cone Spindle	HIGH TORQUE CAP				LOW TORQUE CAP			
	Low Temp 25°C		High Temp 60°C		Low Temp 25°C		High Temp 60°C	
	Brookfield Part #	Viscosity cP (mPa•s)	Brookfield Part #	Viscosity cP (mPa•s)	Brookfield Part #	Viscosity cP (mPa•s)	Brookfield Part #	Viscosity cP (mPa•s)
1	CAP1L	89	CAP1H	89	CAP0L	57	CAP0H	57
2	CAP2L	177	CAP2H	177	CAP1L	89	CAP1H	89
3	CAP3L	354	CAP3H	354	CAP2L	177	CAP2H	177
4	CAP4L	708	CAP4H	708	CAP3L	354	CAP3H	354
5	CAP5L	1,417	CAP5H	1,417	CAP4L	708	CAP4H	708
6	CAP6L	3,542	CAP6H	3,542	CAP5L	1,417	CAP5H	1,417
7	CAP7L	1,328	CAP7H	1,328	CAP1L	89	CAP1H	89
8	CAP8L	5,313	CAP8H	5,313	CAP3L	354	CAP3H	354
9	CAP9L	21,250	CAP9H	21,250	CAP5L	1,417	CAP5H	1,417
10	CAP10L	236	CAP10H	236	CAP2L	177	CAP2H	177

HOW TO SELECT A CAP FLUID

- Determine which viscometer is being used: High Torque or Low Torque.
- Determine which temperature model is being used: Low Temperature (5°C-75°C) or High Temperature (50°C-235°C)
- Determine which cone is being used.

Krebs Viscometer Oil Fluids

Brookfield Part #	Nominal Viscosity Krebs Units	Temp °C
KU61	61	25.0°C
KU73	73	25.0°C
KU87	87	25.0°C
KU99	99	25.0°C
KU106	106	25.0°C

General Purpose Oil Fluids

Brookfield Part #	Nominal Viscosity cP (mPa•s)	Temp °C
B29	29	25.0°C
B200	200	25.0°C
B400	400	25.0°C
B600	600	25.0°C
B1060	1,060	25.0°C
B2000	2,000	25.0°C
B10200	10,200	25.0°C
B21000	21,000	25.0°C
B73000	73,000	25.0°C
B200000	200,000	25.0°C
B360000	360,000	25.0°C

RST Rheometer Oil Fluids (calibrated at 25.0°C)

Cone Spindle	Brookfield Part #	Nominal Viscosity cP (mPa•s)
RCT-25-1	B41000	41,000
RCT-25-2	B73000	73,000
RCT-50-1	B10200	10,200
RCT-50-2	B21000	21,000
RCT-75-1	B4900	4,900
RCT-75-2	B10200	10,200

RST Rheometer Oil Fluids (calibrated at 25.0°C)

Coaxial Spindle	Brookfield Part #	Nominal Viscosity cP (mPa•s)
CCT-DG	B200	200
CCT-40	B2000	2,000
CCT-25	B10200	10,200
CCT-14	B73000	73,000
CCT-8	B360000	360,000



texture analyzer



S



What is texture analysis?

Texture analysis is primarily concerned with measurement of the mechanical properties of a product, often a food product, as they relate to its sensory properties detected by humans. Fifty years of texture research has developed a set of definitions relating the sensory properties of a product to the instrumental properties which can be calculated from the results of a two cycle texture profile analysis test. Texture analyzers perform this test by applying controlled forces to the product and recording its response in the form of force, deformation and time.

These graphs show two ways of looking at the data from one 2 cycle Texture Profile Analysis test. The force vs time graph clearly shows the force peak resulting from each compression cycle, while the force vs distance graph better displays the response of the sample to the application and removal of strain.

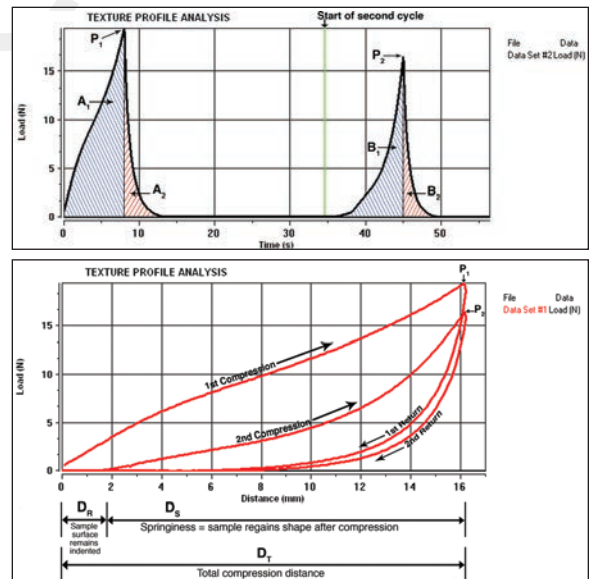

PARAMETERS	SENSORY DEFINITION	INSTRUMENTAL DEFINITION	
Hardness	Force required to compress a food between the molars (Defined as force necessary to attain a given deformation)	Peak force of the first compression cycle	P_1
Resilience (PELEG, 1976)	Measurement of how a sample recovers from deformation in relation to speed and forces derived	Resilience is the ratio of work returned by the sample as compressive strain is removed (known as recoverable work done A_2), to the work required for compression (known as hardness work done A_1)	$\frac{A_2}{A_1}$
Adhesive Force (Fizman and Damaio, 2000)	The maximum force required to separate teeth after biting sample	Maximum negative force generated during probe return	
Adhesiveness	The work necessary to overcome the attractive forces between the surface of the food and the surface of other materials with which the food comes into contact (e.g. tongue, teeth, palate) (Work required to pull food away from a surface)	The negative area for the first bite, representing the work necessary to pull the compressing plunger away from the sample (No adhesiveness is seen in graphs above)	
Springiness Index Preferred for comparing samples of different lengths	Ratio of the height the sample springs back after the first compression compared to the maximum deformation	Springiness divided by total deformation	$\frac{D_s}{D_T}$
Cohesiveness A measurement of how well the structure of a product withstands compression	The strength of internal bonds making up the body of the product (Greater the value the greater the cohesiveness)	The ratio of the work during compression (downward stroke only) of the second cycle B_1 divided by that of the first cycle A_1	$\frac{B_1}{A_1}$
Corrected Cohesiveness (PELEG, 1976)	Net work invested in the non-recoverable deformations of the first and second chews	The ratio of the net work of the second cycle $B_1 - B_2$ divided by that of the first cycle $A_1 - A_2$	$\frac{B_1 - B_2}{A_1 - A_2}$
Chewiness Solid foods only	The energy required to chew a SOLID food to the point required for swallowing it	The product of hardness, cohesiveness and springiness	$P_1 \times \frac{B_1}{A_1} \times D_s$
Corrected Chewiness	The net energy required to chew a SOLID food to the point required for swallowing it	The product of hardness, corrected cohesiveness and springiness	$P_1 \times \left(\frac{B_1 - B_2}{A_1 - A_2} \right) \times D_s$
Gumminess Applies to semi-solid products only if they have no springiness & undergo permanent deformation	Energy required to disintegrate a SEMI-SOLID food product to a state ready for swallowing (Related to foods with low hardness levels)	The product of hardness and cohesiveness	$P_1 \times \frac{B_1}{A_1}$

Why Choose AMETEK Brookfield?

AMETEK Brookfield is recognized around the world for offering high quality measurement instruments at an affordable price. Unsurpassed customer support is but one more reason to choose an AMETEK Brookfield product when you are considering a viscometer, rheometer, texture analyzer or a powder flow tester. To find out about the in-depth service that we provide, ask any customer who has uses one of our viscometers.

The CT3 offers the highest performance/cost ratio on the market. Distance accuracy is assured during calibration for each and every CT3 by storing the unique compensation curve for load cell deflection. Each load cell deflects naturally and uniquely as the force builds to the maximum range for the load cell. This unique deflection of each load cell is stored during calibration and applied to the drive system in real time as the test runs. This compensation assures accurate distance travel regardless of the load force recorded.

The CT3 Texture Analyzer utilizes uni-axial compression and tension forces in combination with a selection from our extensive list of probes, grips and fixtures to test a wide variety of food, personal care products and industrial materials. Most tests desire to imitate conditions imposed on these products during manufacture, handling, and consumption or use. Characterizing the physical properties of your products in such an analytical manner provides “real life” insight and can be invaluable toward maintaining consistent, high quality manufacturing while minimizing cost.

The AMETEK Brookfield Texture Department can also provide customers with complete texture assessment service. We specialize in the development of novel and innovative test applications and accessories for solid and semi-solid materials, enabling our customers to maximize the practical value of their texture studies within all test environments.

AMETEK Brookfield’s compact design of the CT3 has a long heritage dating from the Stevens gelatin Bloom tester. The CT3 still contains the Bloom test method and we now offer the complete gelatin bath preparation system along with GMIA and GME approved Bloom bottles. The system includes a CT3, a rack allowing easy handling of twelve Bloom bottles, two TC-450MX large reservoir baths and a TC-351 chiller.



CT3 Gelatin System

Why Measure Texture?

Consumer products succeed in the marketplace in part because their “textural characteristics” are pleasing to customers. This is certainly true with food products but it also applies to cosmetics, pharmaceuticals, packaging, industrial materials and even adhesive type materials.

Applications

Quality Control, Product Development and R&D

FOOD

Dairy	Bakery	Snack Foods	Meat	Fruit & Vegetables
Butter	Bread	Chips	Beef	
Cheese	Dough	Confections	Poultry	
Tofu	Pastry	Granola Bars	Seafood	
Yogurt			Surimi	

COSMETICS & PERSONAL CARE

Creams	Eye liner pencils	Lipstick
Mascara	Powder compacts	Soap bars

PHARMACEUTICALS

Adhesive dressing	Gelatins	Inhalation	Syringe testing
Tablet hardness	Topicals	Transdermal	

MATERIALS

Adhesives	Caulking	Grease	Packaging
Paste	Rubber	Wax	

Properties Measured

Adhesiveness	Apparent Modulus	Breaking Point
Burst Strength	Chewiness	Coefficient of Friction
Cohesiveness	Consistency	Elasticity
Fracture Force	Gel Strength	Gumminess
Hardness	Pliability	Relaxation
Ripeness	Spreadability	Tackiness
Yield Point		

CT3™ Texture Analyzer

compression and tension testing for rapid QC analysis

An extensive history and customer input have contributed to the development of the most powerful, low cost, stand-alone Texture Analyzer ever produced. With six test modes (plus calibration check) and a wide choice of accessories, no other texture analyzer has ever done so much without requiring a computer and software!

Standard Test Modes

Normal Test:

a single compression cycle

Hold Time Test:

compress and hold

Cycle Count Test:

compress multiple times

Bloom Test:

gelatin bloom strength test

TPA Test:

texture profile analysis

Tension Test:

tensile testing

Surimi Test:

gel strength

Static Load Test:

calibration check

Texture Loader Software

allows up to ten custom tests and ability to lock parameters

Compression distance

up to 10cm, can accommodate sample up to 22.5cm, almost 9 inches tall. Probe shaft is 8cm from back wall.

Choice of Load Cells

7 measurement ranges up to 50kg

Choice of Base Tables

allows for larger samples and more accessory choices



CT3 with Fixture Base Table and Cylindrical Probe in compression (TPA) mode

What's Included?

Instrument with choice of load cell
Texture Loader Software
USB & Power Cables

What else do I need?

Rotary Base Table, Fixture Base Table (see below) or Adjustable Base Table (p66)
At least one probe or test fixture (p60-64)

Optional Accessories

The CT3 has a wide variety of probes, fixtures and jigs which enable it to be very versatile. AMETEK Brookfield can also custom design a fixture and probe for most applications.

TexturePro CT Software TA-CT-PRO-AY (p59)
Temperature Probe DVP-94Y
Bubble Level TA-LVL
Calibration Weight Set (p59)
Gelatin Bath System for gel conditioning (p57)
Bloom Jar - industry approved TA-GBB-2

TexturePro CT Software Optional

COLLECT DATA AND PERFORM DETAILED DATA ANALYSIS WITH REAL-TIME GRAPHIC PLOTTING.

While the CT3 can perform many tests in stand alone mode, use of TexturePro CT Software permits creation of multiple tests and automatic execution without operator involvement.

Easily create custom reports and graphs right from the menu screen.

- Sample identification set-up screen helps new operators quickly get started; test fields outline a variety of parameters
- Intuitive set up for test methods and database file structures in a single window
- Data is captured as a graph and stored in tabular database format
- Advanced data analysis with built-in parameter calculations such as springiness, chewiness, hardness and much more!

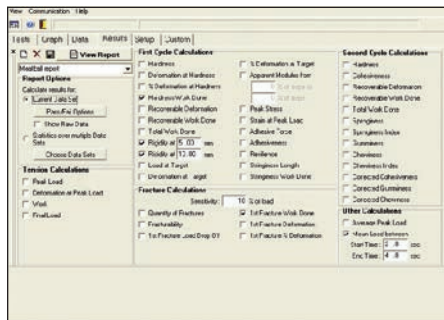

Sample Test Set-up

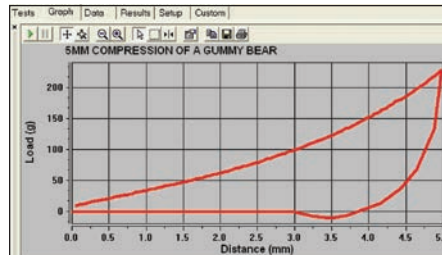

On Screen Live Force Deformation Curve



Tension Mode

provides tensile testing capability

MODEL	Load Range / Resolution*
CT3-100	0-100g/0.01g
CT3-1000	0-1000g/0.10g
CT3-1500	0-1500g/0.20g
CT3-4500	0-4500g/0.50g
CT3-10kg	1-10000g/1.0g
CT3-25kg	1-25000g/2.0g
CT3-50kg	2-50000g/5.0g

g = grams kg = kilograms *Accuracy = ±0.5% Full Scale Range (FSR)

ALL CT3 MODEL SPECIFICATIONS	
Speed:	
Range	0.01-0.1mm/s (increments 0.01mm/s) 0.1 - 10mm/s (increments 0.1mm/s)
Accuracy	±0.1% of setspeed
Position:	
Range	0-101.6mm
Resolution	0.1mm*
Accuracy	0.1mm

mm = millimeter s = seconds
*Resolution 0.01mm when used with TexturePro CT Software



TA-CW-1500C

Calibration Weight Set contains a combination of certified weights which may be used to confirm the calibration and linearity of each specific load cell.

CT3 Accessories

FOR A WIDE RANGE OF TESTS.

While many CT3 accessories have multiple applications, some are particularly useful for specific industries. The following color coded icons are used here to identify these industries.

- F** FOODS
- C** COSMETICS
- P** PHARMACEUTICALS
- M** MATERIALS & PACKAGING
- D** DEVICES - MECHANICAL

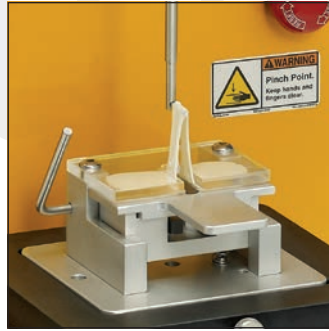

TA-KF F
Kieffer Dough and Gluten Extensibility Fixture quantifies maximum force and distance needed to break sample. Fixture Base Table required.

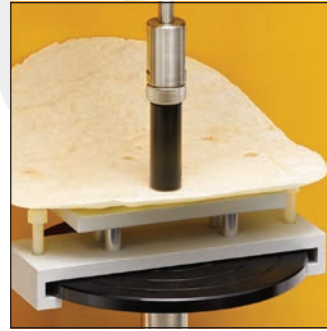

TA-JPA F M
Junior Punch Fixture is for punching through flat samples; 12.7mm max. diameter probe. Hole in fixture is 14mm. Rotary Base Table required.



TA-TPB F
Three Point Bend Fixture is used with TA7 blade from general probe kit. Fixture Base Table required. Small scale version TA-JTPB is available.

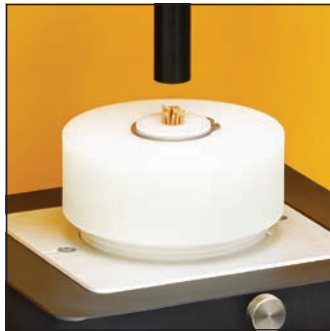

TA-DSJ F
Dough Stickiness Fixture is standard test for measuring dough stickiness; important for processing raw dough. Fixture Base Table required.



TA-DE F
Dough Extensibility Fixture for holding sheet of raw dough or flat bread to measure breaking point of stretched sample. Fixture Base Table required.



TA-CTP F
Compression Top Plate for applying uniform compression forces on samples up to 4x6 inches (10x15cm) Fixture Base Table required.



TA-VBJ F
Volodkevich Bite Jaws for testing bite force of meat products using shear cutting-test. Fixture Base Table required.



TA-PTF F M
Pizza Tensile Fixture quantifies cooked pizza firmness by measuring the tensile force and deformation distance to break sample.



TA-FMBRA F
Standard dough pot set for preparing dough samples and measuring dough firmness.



TA-AACC36 F
AACC spec probe for measuring bread firmness and performing texture profile analysis (TPA). Fixture Base Table required.



TA-SBA-WB-1 F
1mm Shear Blades for cutting-shear test: meat, fish, sausage, etc. TA-SBA-WB-3 option for 3mm blades. Fixture Base Table required.



TA-SFF ⓘ

Spaghetti Flexure Fixture quantifies flexure characteristics of uncooked spaghetti and other dry pastas.



TA-OC-002 ⓘ

Ottawa Cell (447cc) for bulk compression to determine hardness and crispness of cereals, vegetables or fruits. Fixture Base Table required.



TA-PFS ⓘ

Pasta Firmness and Stickiness Fixture measures the firmness and stickiness of uncooked pasta. Fixture Base Table required.

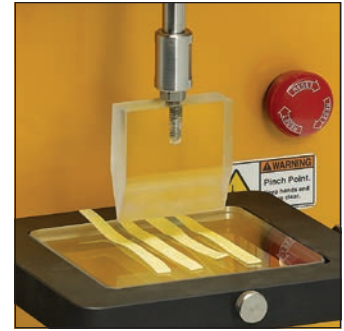

TA-PFS-C ⓘ

Pasta Firmness and Stickiness Fixture measures shear strength when biting pasta and like products. Fixture Base Table required.



TA-KSC-002 ⓘ

Kramer Shear Cell - Sharp to measure shear force of small composite samples such as grapes, corn and beans. Fixture Base Table required.



TA-CSF ⓘ

Circular Support Fixture provides support for round samples and retains any potential fluid expressed during the test. Fixture Base Table required.

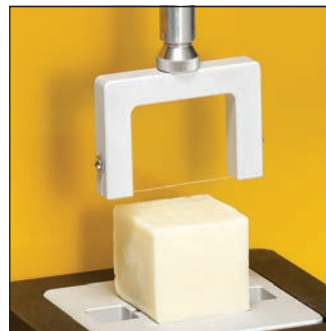

TA-WSP ⓘ

Wire Shear Plate cuts through the sample. Good for products with significant stickiness like cheese and butter. Fixture Base Table required.



TA-CEF ⓘ

Cheese Extensibility Fixture measures the extensibility of molten cheese sample to breaking point.

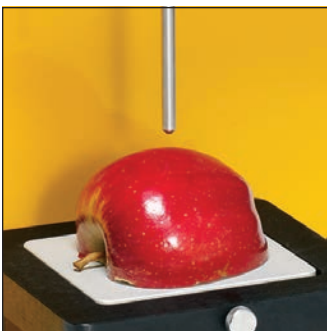

TA-MTP ⓘ

Magness-Taylor Probes for puncture test to measure hardness of fresh fruit and vegetables. Fixture Base Table required.



TA10 ⓘ

GMIA & GME probe and spec Bloom bottle TA-GBB-2 sold in package of twelve bottles.



TA-MCF ⓘ

The Multiple Chip Fixture is used for testing the penetration or firmness of multiple chips / french fries. Fixture Base Table required.



TA-CJ ⓘ

Confectionary Fixture for holding candies and similar products for penetration testing. Fixture Base Table required. Probe not included.

CT3 Accessories

FOR A WIDE RANGE OF TESTS.

While many CT3 accessories have multiple applications, some are particularly useful for specific industries. The following color coded icons are used here to identify these industries.

- F** FOODS
- C** COSMETICS
- P** PHARMACEUTICALS
- M** MATERIALS & PACKAGING
- D** DEVICES - MECHANICAL

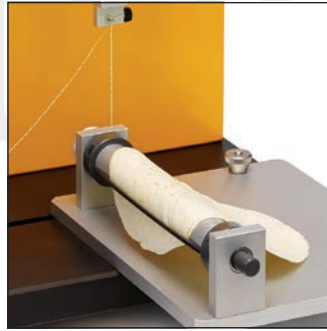

TA-TRF **F**

Tortilla Roll Up Fixture evaluates changes in corn tortilla texture per AACC technical paper by measuring the force to roll up a tortilla.



TA-CKA **F**

Craft Knife Adapter cuts cleanly into and through material with minimum deformation of the sample.



TA-52 MOHRS **F**

Shear Blade used for cutting tests, especially meat, poultry, fish or similar products. Fixture or rotary base table recommended.



TA-MP **F** **M**

Mesh Probe quantifies the consistency of products such as mayonnaise and yogurt.

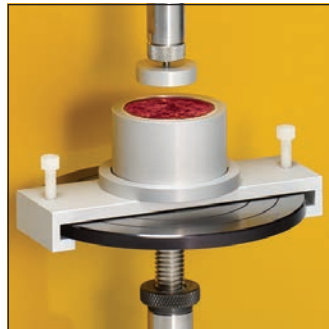

TA-BEC **F** **M**

Back Extrusion Cell for measuring consistency of applesauce, pudding, yogurt and similar products. Rotary Base Table required.

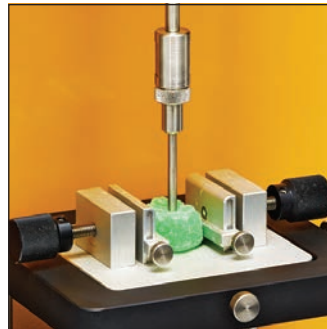

TA-AVJ **F** **M**

Adjustable Vice Fixture for holding small samples for puncture test. Good for jelly beans, gum drops, etc. Rotary Base Table required.



TA-JMPA **F** **P**

Multiple Probe Assembly consisting of nine 3mm probes and base plate designed to hold nine small samples of irregular geometry. Base Table required.



TA-DEC **F** **C** **P**

Dual Extrusion Cell for either forward or back extrusion of fruit puree, pudding, yogurt or similar products. Fixture Base Table required.



TA-STF **C** **P** **F**

Spread Test Fixture quantifies the spread force of a material. Comes with 1 male cone probe, 5 five samples cups and 1 sample cup holder. Base Table required.



TA-HCF **C**

Hair Combability Fixture measures the effect of hair dye, shampoos and conditioners on the combability of hair.



TA-EP **C** **M**

Eye Pencil Test Fixture measures hardness of cosmetic pencil tips for eye- or lip-lining products and can also be used for artistic type pencil tips. Fixture Base Table required.



TA-LC C

Lipstick Cantilever Test Fixture allows imitative tests on lipstick and similar products to quantify strength of product. Fixture Base Table required.

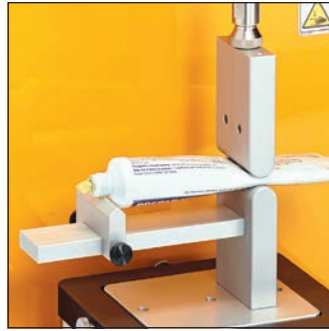

TA-TE C P

Tube Extrusion Jig measures the force needed to squeeze cream, paste or ointment out of a tube. Base Table required.

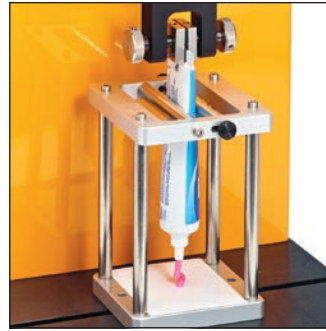

TA-TEF C P

Tube Extrusion Fixture measures continuous extrusion force of tube or sachet samples. Top vice grip included.



TA-MA P

Muco Adhesion Test Fixture Simulates body/temperature conditions and force needed to pull a tablet away from a mucosal surface.



TA-RT P

Raft Tester measures alginate Raft Strength by pulling wire raft hook out of the sample material.



TA-MDI P

Metered Dose Inhaler Fixture measures the push-button force to actuate the inhaler. Fixture Base Table required.



TA-STJ P

Syringe Test Fixture for measuring the force required to push or pull syringe plunger. Important to all syringe markets. Base Table required.



TA-TCA P

Tablet Coating Adhesion Fixture measures the adhesion force of a tablet coating to a tablet. Fixture Base Table required.



TA-BLS P

Bi-Layer Shear Fixture measures shear strength by cutting a two-part tablet or capsule using a guillotine blade. Fixture Base Table required.



TA-BPS P

Blister Pack Support Fixture is used to measure the force required to remove the tablet from its blister pack. Fixture Base Table required.

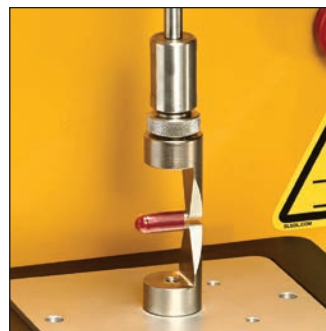

TA-CLT P

Capsule Loop Tensile Test Fixture is used to measure the force required to split one half of a hard gel capsule. Fixture Base Table required.



TA-TCF P

Tablet Compression Fixture performs a ring crush test (includes four rings). Bead compression test fixture is also included. Fixture Base Table required.

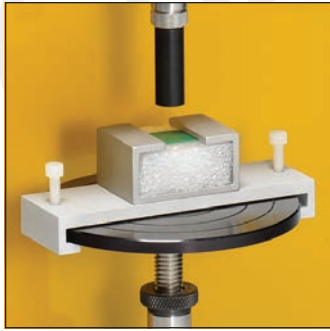

TA-ATT M P

Adhesive Tack Tester for measuring stickiness of pressure sensitive adhesive materials such as tape. Rotary Base Table required.



TA-FSF M P

Film Support Fixture for puncture test to measure strength of fine films. Fixture Base Table required.



TA-LTT M

Loop Tack Test measures the adhesive strength of pressure sensitive tape and stickers according to ASTM D6195.

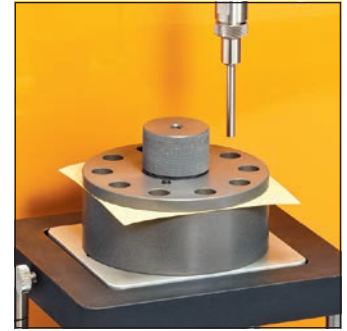

TA-RIF M

Rotary Indexing Fixture measures adhesive force to pull tape off a surface. Multiple tests done on same sample for average value. Fixture Base Table required.

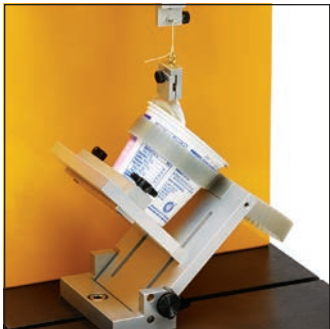

TA-GPJ M

General Peeling Jig measures the adhesive strength needed to remove the lid from a sealed container at 0°, 45°, and 90° angles.



TA-PF180 M

180° Peel Fixture consists of top & bottom grips to measure adhesive strength when pulling tape off rigid surface using force at 180° angle.

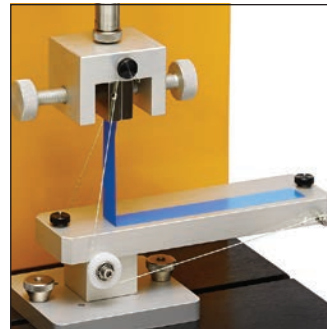

TA-PF90 M

90° Peel Fixture measures the adhesive strength to pull a tape off of a rigid surface using force at a 90° angle.



TA-ATTPT M

Adhesive Test Fixture measures adhesive force of plaster and similar samples. Includes flat cylindrical probe, base plate and top clamp to hold the sample.



TA-DGF M P D

Dual Grip Fixture for tensile testing of thin films or integrity of seals for packaging.

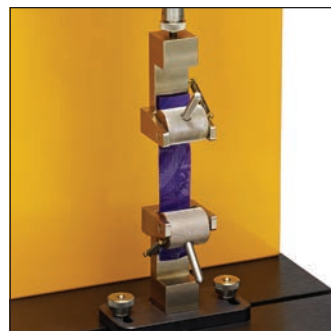

TA-RCA M D

Roller Cam Accessory grips measure the tensile strength and tear characteristics of material such as polymer films.



TA-SFJ M D

Sliding Friction Jig measures the coefficient of friction for packaging materials according to ASTM D1894.



TA11 D

Cylindrical probe TA11 is used to measure the force vs. distance in mechanical springs. TA11: included in TA-P-KIT2 or as a standalone part.



TA-P-KIT2 F C P M D

*General Probe Kit
with Carrying Case*

Variety of probes:

- (1) cutting wire
- (8) cylindrical
- (3) cone
- (1) knife-edge
- (2) ball
- (1) needle

Complies with BS and AACC.

Standard Probes

- | | | |
|----------|-----------|---------------|
| A | TA53 | cutting wire |
| B | TA25/1000 | 50.8mm dia. |
| C | TA4/1000 | 38.1mm dia. |
| D | TA11/1000 | 25.4mm dia. |
| E | TA10 | 12.7mm dia. |
| F | TA17 | 24mm dia. 30° |
| G | TA15/1000 | 30mm dia. 45° |
| H | TA2/1000 | 30mm dia. 60° |
| I | TA7 | knife-edge |
| J | TA43 | 25.4mm dia. |
| K | TA18 | 12.7mm dia. |
| L | TA9 | needle |
| M | TA41 | 6mm dia. |
| N | TA39 | 2mm dia. |
| O | TA44 | 4mm dia. |
| P | TA5 | 12.7mm dia. |

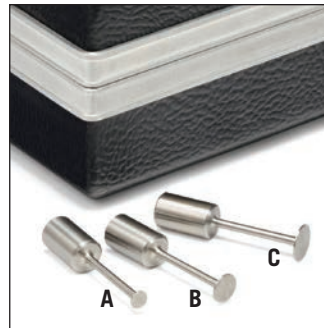

TA-P-KIT3 F

*Curd Probe Kit
one each of:*

- A** TA46 5mm
- B** TA47 8mm
- C** TA48 10mm



TA-CW-1500C

Calibration Weight Set contains a combination of certified weights which may be used to confirm the calibration and linearity of each specific load cell.

Also available:

A variety of cylindrical, cone, ball, needle, knife-edge, and wire cutting probes are also available.

AMETEK Brookfield can also make custom fixtures and probes for a variety of applications. Please contact AMETEK Brookfield or an authorized dealer to discuss solutions to your texture and materials testing challenges.

BASE TABLES



TA-RT-KIT

Rotary Base Table provides quick and easy height adjustment to accommodate samples of various sizes. Included are pair of T-bolts for securing Rotary Base Table to slot in base of CT3 Texture Analyzer.



TA-BT-KIT

Fixture Base Table is rectangular with removable insert which can be used as test surface or replaced with a number of test fixtures. Included are pair of T-bolts for securing Fixture Base Table to slot in base of CT3 Texture Analyzer. Also included are four sets of extension legs with different lengths to adjust the test surface height.



TA-ABT-KIT

Adjustable Base Table for use with fixtures requiring table heights between 1.5" and 5"



The AMETEK Brookfield Texture Analysis Lab

TEXTURE ANALYSIS TESTING SERVICES

A variety of texture analysis testing services can be performed at all AMETEK Brookfield locations (USA, UK, Germany, China and India). Most services are performed free-of-charge.

TEST AND RECOMMEND

A simple evaluation designed to help determine the appropriate CT3 equipment for your application.

SAMPLE PROFILING

Analysis testing to determine specific properties of your sample.

DISPUTE RESOLUTION

Analysis testing for mediating a resolution between producers and/or suppliers in cases where each has different results for the same material.

MULTIPLE SAMPLE TEST

Expands the capability of your laboratory by utilizing AMETEK Brookfield's services to accomplish testing work on a timely basis.

TEXTURE APPLICATIONS

The CT3 Texture Analyzer is used to test many different types of materials. General categories are identified and examples from each are presented.



TA-HCF
Hair Combability
Fixture

COSMETICS

Measure the effect of shampoos and conditioners on the combability of hair. Lipstick firmness is confirmed with a bending test. Extrusion cell characterizes physical consistency of cosmetic creams.

SOME RECOMMENDED CT3 ACCESSORIES

TA-DEC TA-EP TA-HCF TA-LC TA-TEF



TA-NTF
Noodle Tensile
Fixture

FOODS

Evaluate noodle quality by stretching it with tension test. Snap test on cracker gives clear indication of freshness. Two-cycle compression test on bread slice quantifies firmness and springiness.

SOME RECOMMENDED CT3 ACCESSORIES

TA-DE TA-DSJ TA-FMBRA TA-JPA
TA-KF TA-MP TA-PFS TA-PFS-C
TA-PTF TA-SBA TA-SFF TA-TPB
TA-VBJ TA-WSP *and many more*



TA10
GMIA & GME
probe and spec
Bloom bottle

GELATIN

Universal method for establishing the value of gelatin is via the Bloom Test which measures the physical strength of the sample using a cylinder probe.

RECOMMENDED CT3 ACCESSORY

TA10, TA5



TA11
Spring Rate Test
measures force vs
distance of springs

MECHANICAL DEVICES

The CT3 has been extensively tested with various mechanical components. We have solutions for o-ring force vs. compression distance, key pad button actuation force, crimping force test for wire in clamps, life cycle testing for switches and actuators and much more. Call us for details.

RECOMMENDED CT3 ACCESSORY

TA11 TA-DGF TA-RCA TA-SFJ TA-P-KIT2



TA-DGF
Dual Grip Fixture

PACKAGING

Tensile test on package seals determines how hard it will be to rip open. The force required to remove capsules from blister packaging is measured with a finger probe in compression.

SOME RECOMMENDED CT3 ACCESSORIES

TA-ATT TA-AVJ TA-BEC TA-DGA TA-FSF
TA-GPJ TA-JPA TA-LTT TA-PF90 TA-PTF
TA-SFJ TA-TSF



TA-TEF
Tube Extrusion Fixture

PERSONAL CARE PRODUCTS

The squeezing force to extrude creams and pastes is quantified using a support fixture to hold the tube in place while pressing down with a finger-shaped blade.

RECOMMENDED CT3 ACCESSORY

TA-TEF, TA-STE, TA-TE, TA43



TA-BLS
Bilayer Shear
Test Fixture

PHARMACEUTICALS

Measure shear strength of two-part tablet or capsule using guillotine blade. Burst strength of capsule shell is quantified using tension test to rip the capsule apart. Adhesive property of tablet coating is determined with tension test.

SOME RECOMMENDED CT3 ACCESSORIES

TA-BPS TA-DEC TA-FSF TA-MA TA-MDI
TA-RH TA-STF TA-STJ TA-TCA TA-TEF

powder testers



flow

What is powder analysis?



Particulate materials constitute a large group of solids that can range in size from sub micron particles to large rocks and minerals. AMETEK Brookfield's Powder Flow Tester measures the flow behavior of bulk solid materials that have a top particle size of 1mm in diameter using the standard volume 263cc shear cell or 250 microns using the small volume 43cc shear cell. In many instances, powders with larger particles can still be characterized effectively by sieving the material and testing the fines (the fines control the flow properties of a material with a wide size range). The generic term used by AMETEK Brookfield to name these materials is "powder", therefore the name of our instrument is "Powder Flow Tester".

Unlike liquids which, under the influence of gravity, tend to have a horizontal surface, powders exhibit a structure, due to internal friction and cohesion, which allows them to form piles with angles relative to the surface on which they are placed. At ambient conditions, powders do not change flow behavior when subjected to variable shear rates, whereas most liquids do. However, pressure controls the strength of a powder (i.e., increases the resistance to flow) whereas a liquid will show limited change in rheology under pressure. In other words, the consequence of subjecting a powder to a compressive force is that the powder will flow less easily; the relationship between the compressive stress applied to consolidate the powder and the strength it obtains is the measurement of the powder flowability, or its "Flow Function".

There is a need throughout industry to characterize powder flow properties and flow behavior. The AMETEK Brookfield Model PFT Powder Flow Tester is a precision instrument of robust design that satisfies this need and more.

What are the industrial issues with powders?

The classic problem with powders is their failure to discharge reliably from bins, hoppers, silos, etc., and poor or unpredictable flow in feeders, dosing machines, packing machines, etc. This causes unwanted interruptions in the production process, leading at times to complete plant shutdown in order to correct the flow restrictions and stoppages. It also leads to variations in pack weight, mixture, performance and sensory properties of powder products.

Quality Control Departments are constantly dealing with raw materials in powder form, which come from multiple suppliers. The variability in particle size and distribution, moisture content, and basic ingredients requires a battery of incoming inspection tests, none of which assure that proper flow will take place when loaded into the plant equipment. The Powder Flow Tester is a single-solution instrument which can resolve this uncertainty.

R&D Departments are constantly adjusting formulations of powder products to satisfy customer demand for improved properties: better coating action for paints, enhanced taste for spices, rapid dissolving of chemicals when put into solution. New formulations do not necessarily have the same flow properties, thereby leading to production problems when the process is scaled up to high volume. The AMETEK Brookfield Powder Flow Tester can predict those problems so they can be prevented.

How can flow problems with powders be eliminated? Using a Jenike Shear Cell.

Scientific work has been conducted with shear cells for over 50 years to evaluate powder flowability. AMETEK Brookfield collaborated with The Wolfson Centre at University of Greenwich, England, to evaluate these earlier methods before designing its unique annular shear cell now known as AMETEK Brookfield Powder Flow Tester, or simply PFT.

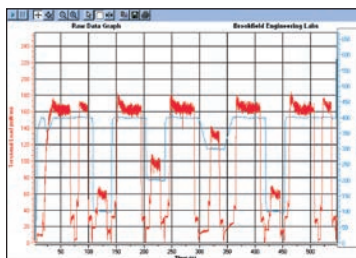

Test algorithm for AMETEK Brookfield PFT requires compression of the sample contained in an annular shear cell to defined axial loads followed by torsional shearing to determine powder failure strengths.

PFT test data produces a graph called “Flow Function”, similar in concept to the “Flow Curve” generated by a Viscometer measuring liquids for viscosity behavior. Flow Function plots compression applied to the powder sample (called Consolidation Stress) on the x-axis vs. yield stress for onset of powder flow (known as failure strength) on the y-axis.

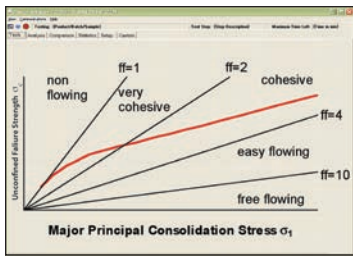

Flow Function curve from PFT test appears in red. Note that industry has established five regions of flow behavior ranging from “non flowing” to “easy flowing”.

Analysis of Flow Function data leads to calculation of values for Fill and Final Bulk Density, Arching Dimension and Rat Hole Diameter. Critical outlet dimensions for feeders and hoppers should exceed the Arching Dimension and Rat Hole Diameter values to minimize potential blockages in mass flow and core flow respectively. A second test on the powder sample called Wall Friction provides additional information for calculation of the hopper half angle needed to achieve mass flow behavior.

All values are calculated automatically by PFT without operator involvement other than loading the powder sample onto the instrument and measuring the weight.

By comparing Flow Function and Wall Friction data for various formulations, powders can be benchmarked and ranked for flowability. New formulations can be quickly compared to existing powder products that have processed successfully in manufacturing. Adjustments can be made to the formulation by the addition of a flow aid and the resulting Flow Function will tell whether the change is sufficient to eliminate potential flow issues.



To perform a calibration check on your Powder Flow Tester, use certified BCR-116 limestone powder. Run the standard Flow Function test at 5 consolidation stresses and record the failure strength values. They must be between published min/max values for the instrument to pass. BCR-116 limestone powder is supplied in 3.2kg jars and certified by the European Commission, Community Bureau of Reference. Contact AMETEK Brookfield for more information.

Why Choose AMETEK Brookfield?

AMETEK Brookfield has over 80 years experience in providing reliable, low cost viscosity and texture measurement instruments while offering high quality product support. We are now using this recipe for success to expand our line of physical testing products to include the Powder Flow Tester.

The AMETEK Brookfield Powder Flow Tester is the simple answer to industry needs:

The purchase price is a small fraction of current devices on the market.

A competent lab technician can run tests and collect data within minutes, eliminating the need for a powder specialist.

The automated analysis provided by the Powder Flow Pro software calculates various properties of the powder, including the critical dimensions for reliable powder flow out of the hoppers, feeders, bins and silos.

The Wolfson Center for Bulk Solids Handling Technology at the University of Greenwich, England, has worked closely with AMETEK Brookfield to design the Powder Flow Tester, thereby, ensuring its suitability for practical industrial use.

Applications

R&D, Incoming Materials Inspection, New Product Formulation, Quality Control, Process Plant Design

Adhesives

Additive
Manufacturing:
3D Printing

Cosmetics

Chemicals

Construction:

Cement
Fly Ash
Gypsum
Hydrated Lime

Detergents

Equipment

Manufacturing:

Silos
Bins
Feeders
Hoppers

Energy:

Biomass
Coal

Fluxes

Food:

Beverages
Biscuits
Cereal
Chocolate
Cocoa/Milk Powder
Cookies
Crackers
Flavorings
Flour
Seasonings
Spices

Gunpowder/ Ammunition

Healthcare
Products:
Tablets

Minerals

Nutraceuticals

Personal Care

Products:

Talcom Powder

Pharmaceuticals

Starch

Properties Measured

Flow function
relation between consolidation stress
and powder strength

Angle of internal friction

Angle of wall friction

Cohesive strength

Bulk density

Arching dimension

Rat-hole diameter

Hopper half angle

PFT™ Powder Flow Tester

...affordable testing for powder characterization

The PFT Powder Flow Tester brings quick and easy analysis of powder flow behavior in industrial processing equipment. Evaluate powder discharge from storage containers. Use as QC check for incoming materials. Rapidly characterize new formulations for flowability and adjust composition to match flow behavior of established products.

Choice of Test Options:

- Flow Function
- Time Consolidated Test with Flow Function
- Wall Friction
- Bulk Density

Choice of Flow Function Tests:

- Standard 5 Point (16 minutes)
- 2 Point (10 minutes)
- Time Consolidation

Real Time Clock Displays:

- Test Step
- Remaining Time to Completion

Shearing Algorithm Captures:

- Peak Stress Value
- Subsequent Stable Stress Value

Data Output Flow Function:

- Flow Index for Powder Flowability
- Arching Dimension
- Rat-hole Diameter
- Hopper Half Angle
- Gravity Chute Angle
- Wall Friction Angle
- Bulk Density

Compact design with small footprint
Tester fits conveniently on workbench
Depth: 15inches / 38cm
Width: 14inches / 36cm
Height: 27inches / 69cm



Developed in association with
The Wolfson Centre
for Bulk Solids Handling Technology
at the University of Greenwich, England.

What's Included?

Instrument
Powder Flow Pro Software
with USB Cable

What else is needed?

Choose one or both:

- Standard Volume Accessory Kit
230cc Trough & 33cc Vane Lid
- Small Volume Accessory Kit
38cc Trough & 5cc Vane Lid

Each of the above include:

- Wall Friction Lid
304 s/s simulated 2B finish
- Outer Catch Tray
- Inner Catch Tray w/ Scraper Tool
- Powder Scoop
- Cleaning Brush

Optional Accessories

- Wall Friction Lids in Mild Steel
22-28RA, Tivar 88 or special order
- Temperature Probe
- Humidity Sensor
- Sieve Kit Standard or Small Volume
- Powder Flow Demonstration Tool



Small Volume Vane Lid
.795-13.252 kPa

Standard Volume Vane Lid
.289-4.819 kPa

Powder Flow Pro Software Included

Operation and control of the Powder Flow Tester is accomplished with Powder Flow Pro Software.

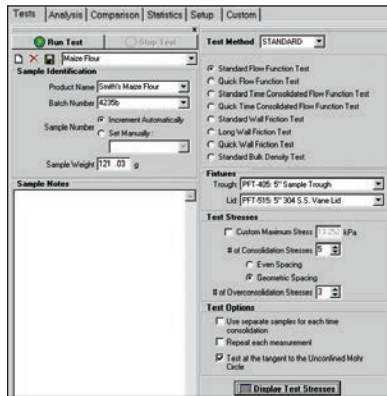

Main screen provides choice of basic tests:

- Flow Function
- Wall Friction
- Time Consolidated Flow Function
- Bulk Density

Custom test options available

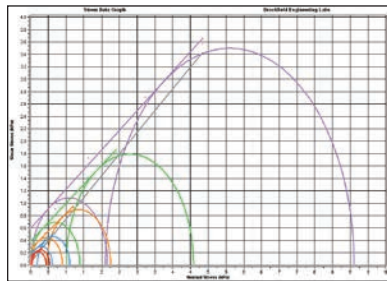

Stress data output screen captures "normal stress" and "shear stress" values and plots data in graphical format (calculates Mohr Circle Failure Loci).

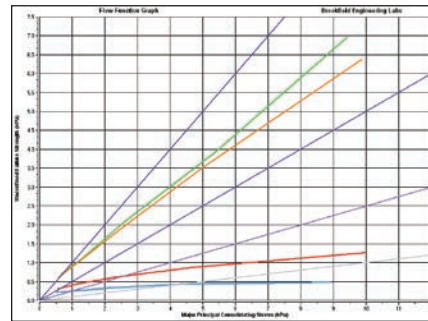

Flow Function test produces graphs of powder flow behavior which show:

- Unconfined Failure Strength vs. Major Principal Consolidating Stress
- Arching Dimension vs. Principal Consolidation Stress
- Rat-hole Diameter vs. Powder Fill Level
- Bulk Density (Fill and Final)

PFT POWDER FLOW TESTER SPECIFICATIONS

Load for Vertical Axis Compression:	7 kg — Accuracy $\pm 0.6\%$ FSR
Axial Speeds:	0.1mm/second up to 5mm/second
Distance:	Accuracy $\pm 0.3\text{mm}$
Torque:	$\pm 7.0 \text{ N}\cdot\text{m}$ — Accuracy $\pm 1.2\%$ FSR
Trough Rotational Speeds:	1 revolution/hour (RPH) up to 5 RPH
Temperature Sensing:	-20°C to 120°C^*
Humidity Sensing:	10% to 95% RH $\pm 5\%^\dagger$
Dimensions (wxdxh):	(cm) 36.2 x 39.7 x 67.6 (in) 14 $\frac{1}{4}$ x 15 $\frac{5}{8}$ x 26 $\frac{5}{8}$
Weight:	34 kg (75 lb)

* Requires Part No. DVP-94Y

† Requires Part No. PFT-607Y

MINIMUM COMPUTER SPECIFICATIONS FOR POWDER FLOW PRO SOFTWARE

2GHz processor with 1 GB of RAM and 30 MB hard drive space available
 1024x768 video resolution with 128 MB of graphics memory
 Windows 7, 8 or 10 (32 and 64 bit) with one USB or RS-232 port



Close-up View of Vane Lid used for Flow Function Test.



Close-up View of Wall Friction Lid for wall friction and bulk density test

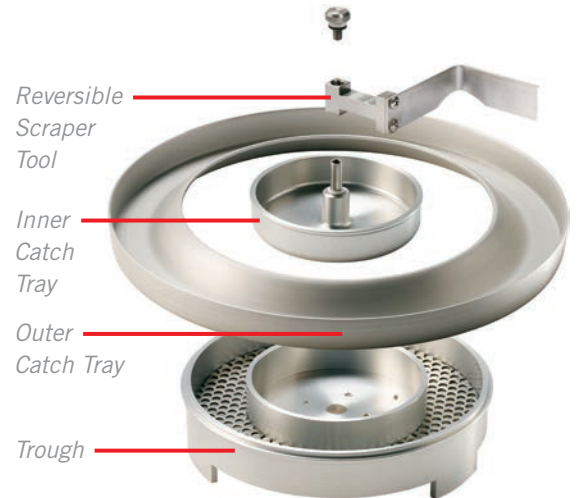

Outer and Inner Catch Trays with Scrapper Tool for Sample Preparation in Trough

Adhesives Applications

recommended viscometer choices



DV2TRV/HB
Viscometer (p10)
Thermosel (p36)
Programmable
Controller (p36)

DV3THBCP
Rheometer (p8)

Adhesives can vary significantly in viscosity. Product viscosity can be modest with easy flow capability to paste-like consistency, requiring high force to apply to a substrate. Choosing the proper test method is critical.

Lab FEATURES & BENEFITS

Multiple choices for “best-fit” instrument and spindle
Guarantees consistent end product from batch-to-batch
Small sample size (<2mL) for high value products

Process FEATURES & BENEFITS

Continuous control of viscosity when applying to substrate
Ensures economic use of adhesives in continuous operations

Chocolate Applications

recommended viscometer choices



DV2THA Viscometer (p10)
or DV3THA Rheometer (p8)
Ball Bearing Suspension (p50)
TC-150 Water Bath (p35)
Small Sample Adapter (p38)
SC4-27 Spindle (p48)
SC4-13RPY Sample Chamber
w/RTD probe (p48)

Measuring chocolate viscosity is important to the confectioner in order to help optimize chocolate flow properties in a melted condition for various mixing and coating applications.

FEATURES & BENEFITS

Determines Casson yield and Plastic Viscosity
Conforms to NCA and Bureau of the Technical Committee Office Internationale du Cacao et du Chocolat.
Control of melting temperatures assuring reproducible comparisons
Easy to clean, easy to operate

Paints, Coatings & Ink Applications

recommended viscometer choices



DV2T Viscometer
not shown (p10)

KU-3
Viscometer (p17)

CAP 2000+
Viscometer (p22)

AMETEK Brookfield has viscometers that have been designed specifically for use in Paint and Coating applications. Whether your requirement is to measure in Krebs units with the KU-3, simulate flow behavior at high shear with the CAP, measure new formulations with DV2T.

FEATURES & BENEFITS

Easy to clean, easy to operate
Instant results, no calculations means fewer errors
Ensure coating quality
Long term reliable performance
Economically priced

Asphalt Applications

recommended viscometer choices



DV2TRV Viscometer (p10)
or DV3TRV Rheometer (p8)
Thermosel (p36)
SC4-27 Spindle (p47)
Programmable Controller (p36)

Specific test methods for measuring the viscosity of highway asphalt “binders” at mixing and compacting temperatures using AMETEK Brookfield’s Thermosel System have been defined by SHRP, the Strategic Highway Research Program, sponsored by the US Government.

FEATURES & BENEFITS

Adheres to ASTM D4402

Ensures asphalt pumpability

Provides variable temperature and shear rate capability for complete viscosity profiles

Personal Care Products Applications

recommended instrument choices



RST-CPS Touch
Rheometer (p25)



CT3 Texture
Analyzer (p58)
w/Extrusion Cell

Shampoos and lotions need to flow easily yet retain sufficient thickness. Viscosity analysis and temperature profiling are important QC tools to use. The R/S-CPS Rheometer is important for comprehensive data analysis.

Viscosity FEATURES & BENEFITS

Small sample volume & rapid temperature control

Texture FEATURES & BENEFITS

The CT3 Texture Analyzer can extrude the semi-solid gel of cream or ointment in a controlled manner, revealing the yield stress and flow characteristics of the product.

Electronics Paste Applications

recommended viscometer choices



DV2THB
Viscometer
(p10)
Spiral Adapter
(p44)
Ball Bearing
Suspension
(p50)

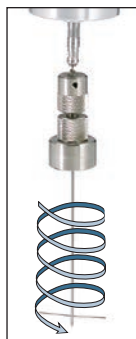

DV1MRV
Viscometer (p12)
Model D Helipath
Stand (p42)

FEATURES & BENEFITS

The rheological properties of solder paste affect behavior during application to electronic assemblies. This includes dispensing operations and flow characteristics during screen and stencil printing. The AMETEK Brookfield DV1MRV Viscometer with Helipath Stand and T-bar spindle provides single point viscosity measurement for QC control. The AMETEK Brookfield DV2THB Viscometer with Spiral Adapter offers an automated test method for total flow curve evaluation.

Spindle can be inserted directly into paste container

Methods comply with IPC test specifications

AMETEK Brookfield In-line Systems also available - call for details

Pharmaceutical Applications

recommended instrument choices



*RST-CPS
Touch
Rheometer
(p25)*



*CT3 Texture
Analyzer (p58)
w/Syringe Test
Fixture*

Viscosity FEATURES & BENEFITS

Most ointments need to be sufficiently thick when standing to prevent them from oozing away from the intended area of use. They also need to flow easily when applied (known as shear thinning behavior). The R/S-CPS Rheometer measures high viscosity at near zero shear rate to determine yield stress values.

Texture FEATURES & BENEFITS

The hardness of a tablet, the dissolution of a tablet or the strength of a gel capsule will have an effect on drug release rate in the body. The CT3 accommodates variable geometries while maximizing the value of data obtained.

Petroleum Applications

recommended instrument choices



PVS Rheometer (p30)



*DV2TLV
Viscometer (p10)*

PVS Rheometer FEATURES & BENEFITS

Fracturing fluids, drilling muds, cements and oil/water emulsions are examples of materials easily analyzed.

Viscosity measurements under pressure & at elevated temperature

Automate standard test procedures

DV2TLV Viscometer FEATURES & BENEFITS

Ensures a quick and easy way to check fracturing fluid viscosity. Special cylindrical spindles provides capability for Low Shear Rate Viscosity Test (LSRV).

Sauces & Dressings Applications

recommended instrument choices



*DV1MRV
Viscometer (p12)
Model D Helipath
Stand (p42)*



*CT3 Texture
Analyzer (p58)
w/Extrusion Cell*

Lab FEATURES & BENEFITS

Multiple instrument/spindle choices to suit most applications

Economically priced to meet low budget requirements

Quick, single point viscosity tests often meet the objective

Texture FEATURES & BENEFITS

Quick, easy method to quantify flow behavior out of the bottle or tube using an Extrusion Cell Fixture

Rugged, easy-to-use instrument for use on the production floor

Use with application software for new formulation testing

Construction Materials

recommended instrument choices



*RST-SST Touch
Rheometer (p27)
Vane Spindle (p47)*



*DV3T
Rheometer (p8)
Vane Spindle (p43)*

The construction industry manufactures a wide range of materials with medium to high viscosity. Methods and spindles are available that can handle materials ranging from gypsum-based joint compounds, cements, concretes, mortars and grouts to various clay mixtures.

FEATURES & BENEFITS

Multiple spindle types can be used with the same instrument minimizing investment cost

Yield stress test gives more information than traditional “slump test”

Flow curves are quickly generated to show complete shear thinning behavior for consistent quality

Dairy Products Applications

recommended instrument choices



*RST-SST Touch
Rheometer (p27)*



*CT3 Texture
Analyzer (p58)*

The dairy industry has a broad range of products requiring viscosity and texture measurement. AMETEK Brookfield instruments ensure consistent quality, flow/spread behavior, and mouth-feel.

Lab FEATURES & BENEFITS

Accommodates homogenous liquids as well as heterogeneous mixtures with particles

Guarantees customer satisfaction because quality is repeatable

Texture FEATURES & BENEFITS

Simple, easy-to-implement test methods

Wide choice of probes to simulate customer experience in handling/consumption of product



process viscome

A high-speed photograph of a water splash against a vibrant yellow background. The water is captured in mid-air, forming a complex, multi-lobed shape with intricate ripples and droplets. The lighting highlights the texture and movement of the liquid. The word "eters" is printed in a clean, white, sans-serif font, partially overlapping the water splash on the left side of the image.

eters

Why measure viscosity in-line?

Why Measure Viscosity In-Line?

Practical application of viscosity measurement data often leads to the need for in-process control of viscosity. The installation of viscosity control equipment on a process can provide a level of control achievable by no other means. Variations in viscosity are detected and corrected instantly before they can negatively affect product quality. Real time viscosity control can reduce downtime and material waste by ensuring that the process is operating within its specified viscosity parameters. In many cases, the savings from increased efficiency can pay back the cost of the viscometer in only a few months.

Why Choose AMETEK Brookfield?

AMETEK Brookfield builds its Process Control Viscometers to the same high standards of performance and value as its Laboratory Viscometers. Particular attention has been devoted to making these instruments rugged and easy to maintain for long service in demanding industrial environments.



FAST-101

Advanced sensor technology for direct in-line viscosity measurement (p82)



FAST-102

Compliant to 3A sanitary standards (p82)



TT-100

For in-line system applications requiring pipeline mounting (p82)



PV-100

In-tank, Probe Viscometer for pressurized systems (p83)



Viscosel

For systems open to the atmosphere (p83)

Questions to Consider

1. What is the viscosity range of your material?
2. Is your material Newtonian, Dilatant, Non-Newtonian, Thixotropic or Plastic?
3. What is the minimum, maximum and average pressure requirement of your application?
4. What is the minimum, maximum and average temperature of your application?
5. What is the minimum, maximum and average flow rate of your application?
6. Where in production would you like the viscometer: in-line, on the top of the tank or on the side of the tank?
7. What electrical code requirements do you have:
 - NEMA 1 (general purpose—indoor)
 - NEMA 4 (watertight/dust tight for indoor/outdoor use)
 - NEMA 7 (explosion proof—Class 1, Div. 1&2, Group D)
 - ATEX (explosion proof—Code: EE x d 11B T6)

The above parameters may eliminate some of the instrument models because, for example, the viscosity is higher than the range of the instrument or outside of the pressure rating of the instrument. In many cases, more than one instrument may be applicable.

Please allow us to assist you in choosing the best viscosity control system for your application.

In-Line Viscometers Provide Automatic Control of Process Fluid Viscosity

There are many ways that viscosity can be measured, such as capillary, vibration and rotational. These methods have different benefits and may work well for process monitoring or control but will likely not give the same values as laboratory or analytical methods. In general, laboratories require a more scientifically accurate measurement, while process control requires a stable, repeatable signal. Process measurements are made both in-line and off-line. A bench-top viscometer has often been used for off-line measurements wherein a sample of the process fluid is drawn and tested under controlled conditions (temperature, shear history, shear rate, etc.). In-line viscometers are immersed in the process stream. They measure and control continuously under process conditions helping to maintain a consistent quality product. The demands of these two environments are different, and it is unlikely the same equipment can be used for both or that the exact same results will be generated. However, if done properly, the results will follow the same trend and can be correlated to the bench top, making in-line measurement useful for ensuring consistent production quality.

WHAT ARE THE BENEFITS TO BRINGING YOUR MEASUREMENT IN-LINE?

In-line measurements give real-time, continuous readings of the fluid's viscosity during processing and consequently provide a means to automate the modification and viscosity control of the process fluid. While it is difficult to control all the factors present in the process that affect the fluids' viscosity (such as temperature, air bubbles, shear history, turbulence, pressure variations, etc.), if these factors are kept relatively constant, then good control can be achieved.

WHAT EFFICIENCIES ARE GAINED BY MEASURING IN-LINE?

Automatic control of the process fluid viscosity insures consistent product all the time and reduces or eliminates human errors and expensive sample testing. Also, it provides for a complete record of how the process varied over a span of time, instead of at just one point in time.

WHAT ARE THE TOP THREE FACTORS TO CONSIDER WITH CHANGING YOUR MEASUREMENT PROCESS?

For process measurements, the critical factors are stability, repeatability, and sensitivity to changes in viscosity. In the laboratory or for analysis environment controls (e.g. temperature, flow, sedimentation, air, etc.) and scientific measurements (controlled shear, geometry measurements and sample preparation) must also be included.

HOW DOES MONITORING THE VISCOSITY AFFECT PRODUCT QUALITY?

Most products are formulated to flow or spread in a controlled manner. Monitoring viscosity at critical shear points ensures that the product will act the same way every time the customer uses it. This is the most tangible indicator of quality.

Manual Viscosity Control

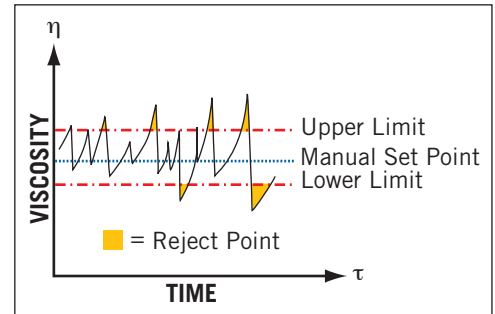

In-Line Viscosity Control

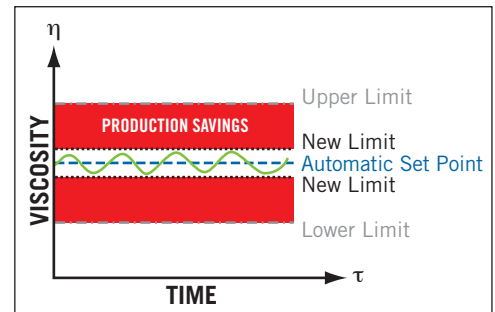

**For more information,
call or visit our website
to request your copy of our
Process Viscometers Catalog**

FAST-101™ Viscosity Controller

Advanced Sensor Technology for simple, direct in-line viscosity measurement



FAST-102

Compliant to 3A sanitary standards



Probe Style

Allows for insertion into the tank from above



Flange Mount

Designs are available to allow direct mounting onto a process tank through a sidewall flange.



What's Available?

Vibrating Element Viscosity Sensor in Nema 4, Nema 7, ATEX, Sanitary, or Ink System Configurations

Optional Accessories

- | | |
|---------------------------|--------------------------|
| Single Station Controller | Multi-Station Controller |
| Mounting Brackets | Solenoid Control Valve |
| Viscosity Standards (p52) | |

TT-100™ Viscometer

for in-line system applications



Viscosel™ Series

for systems open to the atmosphere



What's Available?

VTE-250 In-Line Rotational Viscometer

- Optional Accessories**
- Sample chambers
 - Solenoid Control Valve
 - Solvent Bottle
 - Test Stand
 - Mounting Brackets
 - Additional Spindles
 - Viscosity Standards (p52)

PV-100™ Viscometer

for in-line system applications



What's Available?

PV-100 Rotational Viscometer in NEMA 4 or NEMA 7 (explosion proof Class 1, Division 1 & 2, Group D design)

- Optional Configurations**
- PT temperature sensor
 - Readout indicator/controller

What's Available?

Rotational, Couette Flow Viscometer in Nema 4, Nema 7 (explosion proof Class I, Division 1 & 2, Group D design), ATEX or Sanitary Configurations

- Optional Accessories**
- Optional 12V or 24V DC operation
 - Readout Indicator
 - Variable Speed Motor

Testing & Consulting

Viscosity Testing Services Available

TEST AND RECOMMEND

A simple evaluation designed to help determine the appropriate AMETEK Brookfield equipment for your application.

FLUID PROFILING

Analysis testing to determine properties of your fluid sample. We will supply a complete report on the characteristics of your sample.

DISPUTE RESOLUTION

Analysis testing for mediating a resolution between producers and/or suppliers obtaining varying viscosity results of the same material.

MULTIPLE SAMPLE TEST

Expands the capability of your laboratory by utilizing AMETEK Brookfield's services to accomplish testing work on a timely basis.

Viscosity Test Services are performed for a fee with the exception of "Test and Recommend".

For more information, contact our Rheology Laboratory:
Tel: 800.628.8139 or 508.946.6200, ext. 7144
Fax: 508.946.6262
E-mail: ma-mid.info@ametek.com

Methodology Consulting Service On Viscosity Test Development*

A DETAILED REPORT WILL INCLUDE:

- Sample preparation method
- Equipment recommendations
- Controlled shear rate and shear stress tests
- Temperature profiling
- Thixotropic testing
- Material structure recovery evaluation
- Data collection and reporting
- QC viscosity control limit values

For more information, contact our Rheology Laboratory:
Tel: 800.628.8139 or 508.946.6200, ext. 7144
Fax: 508.946.6262
E-mail: ma-mid.info@ametek.com

*Note: Consulting Services can also be scheduled to take place at AMETEK Brookfield's facility in Middleboro, MA



AMETEK Brookfield's state-of-the-art laboratory offers a variety of viscosity testing services capable of measuring Newtonian and non-Newtonian fluids using a wide range of spindle geometries. Detailed test results include equipment and measurement system description, viscosity data which includes appropriate tables and graphs, and any recommendations pertinent to your specific material and associated method.



The key to successful quality control is designing effective viscosity test methods. Our Methodology Consulting Service brings a AMETEK Brookfield consulting engineer to your facility to review and recommend appropriate test methods for your materials. We will work with you to define acceptable viscosity behavior taking into consideration relevant shear rates, shear stresses, temperature and time sensitivity issues.

Calibration & Certification

for long life and optimal performance of your Viscometer, Rheometer, Texture Analyzer and Powder Flow Tester

Service Center Calibration and Certification

AMETEK Brookfield recommends that you return your instrument to AMETEK Brookfield or an authorized dealer on an annual basis for our Calibration and Certification Service. Please call for a Return Authorization Number.

SPECIAL ARRANGEMENTS:

Loan instruments are available should you need a temporary replacement while your instrument is in for service. Contact AMETEK Brookfield or an authorized dealer.

Twenty-Four and 48 hour rush service can be arranged. Call for details.

Ball Bearing Retrofit for RV/HA/HB torque range on any standard AMETEK Brookfield Viscometer or Rheometer.

SPECIAL INSTRUMENT TESTING PER CUSTOMER SPECIFICATION

When sending your instrument to AMETEK Brookfield for the Calibration and Certification Service, there may be additional tests that you would like AMETEK Brookfield to perform. One example is a calibration check using a viscosity standard fluid similar to the one you use in your laboratory. This testing can be requested when the instrument is returned to AMETEK Brookfield. Complete test results will be included with the instrument when you receive it back at your facility. Our standard hourly rate for lab services will apply.

Contact the Customer Service Department for complete details:

T: 800.628.8139 or 508.946.6200 E-mail: ma-mid.ccs@ametek.com

Outside the United States, contact our authorized representatives. See Pages 89-91 for a comprehensive list.

On-Site Service Calibration and Certification*

We now offer On-Site Calibration and Certification Service. Ideal for multiple instrument users, this service allows all your instruments to be serviced at your facility by our trained technician in one convenient visit.

BENEFITS INCLUDE:

- Minimal production disruption
- Reduced down time
- No shipping damage or costs
- Expert on-site advice in preventative maintenance

For more information, contact our Field Service Specialists:

T: 800.628.8139 or 508.946.6200 E-mail: ma-mid.onsite@ametek.com

*Note: Spindle straightening not performed on-site. Spindles must be shipped to AMETEK Brookfield

IQ, OQ, PQ for AMETEK Brookfield Products

For those customers in specific industries who need documented validation of installed instrument systems we offer a number of approaches. Call for details or go to www.brookfieldengineering.com.

VISCOSITY STANDARDS FLUIDS should be replaced annually

See pages 52 & 53 for details.

BALL BEARING SUSPENSION OPTION

See pages 50 for details.

EZ-LOCK SPINDLE COUPLING SYSTEM

See pages 50 for details.



For your viscometers and rheometers, we will inspect your instrument for wear, clean, adjust and lubricate the internal mechanisms, replace part of the sensing system element (the pivot support assembly and, when required, the pointer shaft), and check your spindles. Spindles that are returned to a AMETEK Brookfield Service Center are also straightened if necessary. In addition to this maintenance, we calibrate and certify in writing that your instrument is operating within proper AMETEK Brookfield specifications. This certification states that your instrument has been calibrated against standards which are traceable to the National Institute of Standards & Technology (NIST). This is becoming an increasingly important requirement as industry throughout the world takes steps to comply with ISO 9000 regulations.

For texture analyzers, we also inspect for wear, clean, adjust and lubricate internal mechanisms, and adjust, if necessary, the zero and span for proper load cell performance. Certified calibration weights can be purchased for your texture analyzer.

Education



Practical Course on Viscosity Measurements

A one-day course designed to address the major concerns about AMETEK Brookfield rotational viscosity measurements. At this course, you will learn:

- Principle of Operation: How the viscometer makes measurements
- Calibration: The truth about calibration checks
- Rheology: Why fluids change their flow behavior and why you need to understand it
- Methodology: How to write a method everyone can live with — and use
- Data Interpretation: What all the viscosity data really means

TWO OPTIONS FOR ATTENDANCE ARE OFFERED:

Option #1: At AMETEK Brookfield, Middleboro, MA

- Provides hands-on lab time, small class size and the opportunity to test your sample

Option #2: At major metropolitan areas

- Regionally located for convenience
- Limited hands-on time with your fluid

Lab Day/Advanced Viscosity Test Methods

Is offered by request only for companies with seven or more participants

A one-day, advanced course goes beyond pass/fail criteria. Using real world sample testing, the class examines how to apply viscometric data as a problem solving/product performance/processing tool. Discussion topics include how AMETEK Brookfield Rotational Viscometers and Rheometers can be used to provide meaningful analysis of your products. This course is offered by request for companies who have training requirements for seven or more participants.

Practical Course on Texture Analysis

A single-day course designed to provide a better understanding of texture analysis as well as the practical use of AMETEK Brookfield Texture Analyzers. This course addresses:

- Principles of texture analysis
- Considerations for successful instrumental measurements
- An overview of accessories and their applications
- Proper texture testing measurements
- Developing test method

Who are the instructors?

Experienced presenters from the technical staff of AMETEK Brookfield Engineering Laboratories lead each seminar.

What else?

Customers are encouraged to bring samples of their material for discussion with prior approval.

Course Attendees will receive a course workbook and AMETEK Brookfield Training Certificate for their training records.

Note: Classes can be presented at the customer's site. Please ask for information regarding this option.

For more information on the schedules or to register for a course, contact the Customer Training Department at AMETEK Brookfield:

Tel: 800.628.8139 or 508.946.6200

Fax: 508.946.6262

E-mail: ma-mid.training@ametek.com

Help & Resources

Feeling overwhelmed? Our Customer Service or Technical Sales Departments can help guide you toward the proper instrumentation and measuring technique for your application. We also offer courses, free technical papers, and a website full of videos, application notes, and manuals.

Frequently asked questions

YOU MAY WANT TO REVIEW THESE BEFORE CALLING FOR ASSISTANCE.

I've read page 7 regarding model selection, and I've reviewed the models available to me, but I'm still unsure — can you test my product for me?

AMETEK Brookfield has a test and recommend service wherein we will test your sample and make a product and method recommendation to help get you up and running. Please call us for details.

Do I need an accessory?

There are no firm rules for determining when an accessory is required. If your test method is not already established within your company, we recommend calling AMETEK Brookfield so that we may review the best choices available for your specific application. As a general guideline, you may want to consider and discuss with us the accessories shown in [blue](#) if any of the following apply to your situation:

- The product is similar to the consistency of water.
[Consider: UL Adapter](#)
- The product is similar to the consistency of peanut butter.
[Consider: Helipath Stand](#)
- The product has suspended solids, similar to relish.
[Consider: vane spindles](#)
- The product sample is limited.
[Consider: Small Sample Adapter accessory or Cone/Plate Viscometer](#)
- The product must remain at a consistent temperature.
[Consider: TC series water bath](#)
- The product is wax-like and needs to be melted at a high temperature just like asphalt
[Consider: Thermosel](#)
- The product is very paste-like similar to solder paste.
[Consider: Spiral Adapter or R/S Rheometer](#)

Do I need software?

Our software provides an easy way to gather data, plot graphs, export data to Excel and should be considered if detailed records are needed or if you want a more automated process. Software is also ideal for multiple operators and complex or repetitive testing.

Do I need a viscosity standard and when should it be replaced?

Yes, verification of instrument calibration with a viscosity standard should be done periodically to ensure that your instrument is in calibration and providing reliable results. We typically recommend replacement of standards every 6-12 months depending on the frequency of use and material tested.

Is verifying calibration the same as the yearly calibration service that AMETEK Brookfield recommends?

No, verifying calibration is performed by you using viscosity standard fluids in accordance to the procedure outlined in the instrument's operator manual. Our Calibration & Certification Service is similar to getting your car's oil changed and a tune-up. You return your instrument to us, and we clean, adjust and lubricate the internal mechanism. We also replace part of the sensing system when necessary, and certify that the instrument is working properly in compliance with ISO 9000 regulations.

Other Educational Resources

SEMINARS

Our popular Practical Course on Viscosity Measurements seminar is ideal for someone new to viscosity. This single-day class includes an overview of viscosity, measurement method discussions and hands-on testing to demonstrate what is being learned in the classroom session. A brief overview on AMETEK Brookfield Viscometers and accessories is part of the curriculum and may also be helpful to those who have yet to choose an instrument. A similar course is also offered for texture analysis.

VIDEOS, APPLICATION NOTES AND OTHER PUBLICATIONS

Online help is available 24/7 on the AMETEK Brookfield website: www.belusa.com. Navigate to the LEARNING CENTER tab for a more in-depth discussion on viscosity, rheology, texture and powder flow as well as helpful videos, more frequently asked questions, product instruction manuals, a calibration template and many other technical publications. Videos are also available on our AMETEK Brookfield YouTube channel.

3A

A US industrial standard for process equipment design; required certification for clean-in-place capability.

Absolute Viscosity

The viscosity value associated with a Newtonian material

Angle of Wall Friction

Represents the friction between the sliding powder and the wall of the hopper or chute at the onset of flow

Arching Dimension

Minimum hopper outlet size needed to insure that the powder will discharge in Mass Flow instead of forming a stable arch across the opening.

ASTM

American Society of Testing and Materials

Autorange

Maximum viscosity value that can be measured using a specific spindle at a designed rpm.

Bob

spindle used with PVS and R/S series rheometers; also referred to as “bob/stator” because it does not rotate on this instrument. The sample cup rotates instead, causing the shearing action.

Bulk Density

The mass of the powder divided by its total volume

Cohesion

A measure of the strength retained by a powder after it has been compacted to a given consolidation level

Concentric Cylinder

A cylinder within a cylinder. For viscosity measurement, a cylindrical spindle rotates within a cylindrical chamber. Also known as “Coaxial Cylinder” because both cylinders have the same center line.

Consolidation

The process of applying a normal and a shear stress to a bulk solid to move the particles together in order to observe any increases in its cohesion, bulk density, etc.

Core-Flow

A first in-last out discharge pattern where the powder flows from the top of the vessel through a vertical channel above the outlet. Powder that is near the walls of the vessel remain stagnant until the level descends to the point where the powder is at the top surface.

dyne•cm

A unit of measurement for torque.

Gap

The distance between the spindle and the chamber or cup in which the spindle is rotating.

Hopper Half Angle

Maximum angle of the converging hopper wall (from the vertical axis) to insure mass flow. Angles greater (shallower) than this will produce core flow.

In-line

Process viscometer placement in a pipe.

Loose Fill Density

The bulk density of the powder in the trough before any stress is applied.

Mass Flow

A first in-first out discharge pattern where the powder flows at the vessel walls and all the material is in motion.

NIST

National Institute of Standards and Technology. US Government organization for test standards.

Newtonian

a material whose viscosity value is the same at all shear rates (e.g. water, honey).

Non-Newtonian

A material whose viscosity changes as shear rate changes (shampoo, mayonnaise).

On-line

Use of a process viscometer to provide continuous viscosity measurement of a material.

Pneumatic

Air operated

PP

Plate and plate geometry.

Rathole Diameter

Minimum outlet diameter of a core flow hopper needed to insure that the powder will flow instead of forming a stable rathole.

Relative Viscosity

The viscosity value of a non-Newtonian material at a defined shear rate.

RPM

Rotations per minute; a unit of measurement for spindle speed.

RTD

Resistance thermal detector; type of sensor for measuring temperature

sec⁻¹

The scientific unit of measurement for shear rate; expressed as “reciprocal seconds” or “inverse seconds.”

Shear Rate

The velocity gradient in a flowing material; the shape and rotational speed of the spindle rotating in a chamber or cup are used to calculate shear rate.

Shear Stress

The force per unit area used to move a material.

Spindle Geometry

The shape of a spindle. AMETEK Brookfield spindles supplied with standard Viscometers/Rheometers (Dial Reading, DV-E, DV1, DV2T, DV3T) are disc type. Other choices include Cylindrical, Cone, Plate, KREBS, etc.

Torque Range

The torque measurement capability of a AMETEK Brookfield Viscometer/Rheometer measured in dyne•cm; designations such as LV, RV, HA or HB are used to define the Torque Range for a specific instrument.

Torque %

The amount of torque resistance measured by a rotating spindle immersed in a material.

Yield Stress

The amount of force required to cause a material to flow.

Conversion Tables**Viscosity**

1 cP	=	1 mPa•s
1 P	=	100 cP
1 Pa•s	=	1,000 mPa•s

Sample Volume

1 L	=	1000 mL
1 mL	=	1000 µL
1 gal	=	8 pt. = 3.7 L
1 pt	=	16 oz.

Torque Range

LV	=	673.7 dyne•cm
RV	=	7,187 dyne•cm
HA	=	14,374 dyne•cm
HB	=	57,496 dyne•cm
5xHB	=	287,480 dyne•cm
1N•m	=	10 ⁷ dyne•cm

Temperature

°C	=	$\frac{5}{9} (°F-32)$
----	---	-----------------------

Texture

1 Kg	=	1000 g
1 Kg	=	9.8 N
1 inch	=	2.54 cm
1 cm	=	10 mm

Please refer to AMETEK Brookfield's publication "More Solutions to Sticky Problems" for a detailed explanation of viscosity and AMETEK Brookfield methodology for making measurements.

DOMESTIC DEALERS

L Laboratory **P** Powder Flow
T Texture **P** Process

ARIZONA**PHOENIX INSTRUMENTATION, INC.**

L T P P
Phoenix, AZ 85021
Tel: (602) 393-3045
E-mail: sales@iwestco.com
Website: www.phoenixinstrumentation.com

CALIFORNIA**CFM-SF, INC.**

L T P P
Martinez, CA 94553
Tel: (925) 370-1500
E-mail: sales@iwestco.com
Website: www.cfmcontrols.com

GOLDEN STATE CONTROLS

L T P P
Irvine, CA 92618
Tel: (949) 559-1941
E-mail: sales@iwestco.com
Website: www.iwestco.com

PACIFIC PROCESS INC.

L T
Los Angeles, CA 91387
Tel: (661) 424-1690
E-mail: pacificprocess@gmail.com

COLORADO (oil and gas only)**JD INSTRUMENTS, INC.**

P
Houston, TX 77224
Tel: (713) 468-8087
E-mail: sales@jdinstruments.com
Website: www.jdinstruments.com

COLORADO**CFM PROCESS CONTROLS**

L T P P
Commerce City, CO 80214
Tel: (303) 232-4996
E-mail: sales@iwestco.com
Website: www.cfmprocesscontrols.com

FLORIDA**PAUL N. GARDNER COMPANY**

L T P P
Pompano Beach, FL 33060
Tel: (954) 946-9454 (800) 762-2478
E-mail: gardner@gardco.com
Website: www.gardco.com

ILLINOIS**BROOKFIELD AMETEK**

L T P P P
Mt. Prospect, IL 60056
Tel: (847) 368-8472
E-mail: davidc.larson@ametec.com
website: www.belusa.com

NEW ENGLAND STATES, NEW YORK**NORTHEAST ENGINEERING**

L T P P P
Cataumet, MA 02534
Tel: (800) 426-1239
E-mail: scrowley@northeastengineering.com
Website: www.northeastengineering.com

MARYLAND**BYK-GARDNER USA**

L
Columbia, MD 21046-2729
Tel: (800) 343-7721 (301) 483-6500
E-mail: info.byk.gardner.usa@altana.com
Website: www.byk.com

MICHIGAN**ADVANCE AUTOMATED SYSTEMS, INC.**

L P
Sparta, MI 49345
Tel: (616) 887-0316
E-mail: dale@advanceautomatedsystems.com
Website: advanceautomatedsystems.com

MISSOURI**ECC SUPPLY COMPANY**

L T P P P
St. Louis, MO 63144
Tel: (314) 645-2420
E-mail: mkrziske@eccstl.com
Website: www.eccstl.com

MONTANA, WYOMING**CFM PROCESS CONTROLS**

L T P P P
Commerce City, CO 80214
Tel: (303) 232-4996
E-mail: sales@iwestco.com
Website: www.cfmprocesscontrols.com

MONTANA, NORTH DAKOTA, WYOMING (oil and gas only)**JD INSTRUMENTS, INC.**

P
Houston, TX 77224
Tel: (713) 468-8087
E-mail: sales@jdinstruments.com
Website: www.jdinstruments.com

NORTH CAROLINA, SOUTH CAROLINA**W.K. HILE COMPANY, INC.**

L T P P P
Matthews, NC 28106
Tel: (704) 847-9125
E-mail: sales@wkhile.com
Website: www.wkhile.com

OHIO**FOX & DOLE TECHNICAL SALES, INC.**

L T P P
Cleveland, OH 44146
Tel: (440) 735-0100
E-mail: sales@foxanddole.com
Website: www.foxanddole.com

W.T. BRYAN & ASSOCIATES, INC.

L T P P P
Cincinnati, OH 45240
Tel: (513) 522-8532
E-mail: AliceKelsey@wtbryan.com
Website: www.wtbryan.com

PENNSYLVANIA, NEW YORK**FOX & DOLE TECHNICAL SALES, INC.**

L T P P
Bridgeville, PA 15017
Tel: (412) 257-0200
E-mail: sales@foxanddole.com
Website: www.foxanddole.com

IVES EQUIPMENT CORP.

L T P P P
King of Prussia, PA 19406
Tel: (610) 768-1600
E-mail: sales@ivesmail.com
Website: www.ivesequipment.com

TEXAS**JD INSTRUMENTS, INC.**

L T P P P
Houston, TX 77224
Tel: (713) 468-8087
E-mail: sales@jdinstruments.com
Website: www.jdinstruments.com

TENNESSEE**CONTROL MANAGEMENT TECHNOLOGY LLC**

P
Knoxville, TN 37922
Tel: (865) 584-0208
E-mail: sales@controlmgmt.com
Website: www.controlmgmt.com

UTAH**MOUNTAIN STATES INSTRUMENTS**

L T P P P
Salt Lake City, UT 84120
Tel: (801) 521-8045
E-mail: sales@iwestco.com
Website: www.iwestco.com

WASHINGTON**FIELD INSTRUMENTS & CONTROLS**

P
Spokane, WA 99218
Tel: (509) 466-8226
E-mail: sales@fieldinst.com
Website: www.fieldinst.com

EXPORT DEALERS

L Laboratory **P** Powder Flow
T Texture **P** Process

ALGERIA, MOROCCO, TUNISIA**LABOMAT ESSOR**

L T P
Saint-Denis, France
Tel: (33) 1/4809-6611
E-mail: info@labomat.com
Website: www.labomat.eu

ARGENTINA**BIO ANALÍTICA ARGENTINA S.A.**

L T P
Buenos Aires, Argentina
Tel: (54) 11/4909-2600
E-mail: info@bioanalitica.com.ar
Website: www.bioanalitica.com.ar

pH. ELECTRONICA S.A.

P
Capital Federal BS AS, Argentina
Tel: (54) 11/4331-0707
E-mail: luftman@phelectronica.com.ar
Website: www.phelectronica.com.ar

AUSTRALIA**JOHN MORRIS GROUP PTY LTD**

L T P P P
Sydney, Australia
Tel: (61) 7/3212-5240; 1300 501 555
E-mail: info@johnmorrisgroup.com
Website: www.johnmorrisgroup.com

AUSTRIA**METROHM INULA GmbH**

L T P P P
Vienna, Austria
Tel: (43) 1/405-6235
E-mail: office@metrohm.at
Website: www.metrohm.at

BANGLADESH**BANGLADESH SCIENTIFIC INSTRUMENT COMPANY**

L T
Dhaka, Bangladesh
Tel: (880) 2/955-3274
E-mail: bssibd@citech.net
Website: www.bsicbd.com

BELARUS**BELAQUILON ODO**

L T P P
Minsk Region, Belarus
Tel: (375) 17/502-2650
E-mail: info@belaquilon.by
Website: www.belaquilon.by

BELGIUM**ANALIS N.V.**

L P
9051 Sint-Denijs-Westrem, Belgium
Tel: (32) 9/243-7710
E-mail: phystest@analisis.be
Website: www.analisis.be

ELSCOLAB NV.

L T P P
Kruibeke, Belgium
Tel: (32) 3/250-1570
E-mail: elscolab@elscolab.com
Website: www.elscolab.com

BRAZIL**ALEM MAR COMERCIAL E INDUSTRIAL S.A.**

L T P P
São Paulo, SP, Brazil
Tel: (55) 11/3229-8344
E-mail: alemmar@alemmar.com.br
Website: www.alemmar.net.br

BRASEQ BRASILEIRA DE EQUIPAMENTOS LTDA.

L T P P P
Jarinu, SP, Brazil
Tel: (55) 11/4016-0000
E-mail: braseq@braseq.com.br
Website: www.braseq.com.br

BULGARIA/MACEDONIA**MARVEL LTD.**

L T P P
Plovdiv, Bulgaria
Tel: (359) 32/678026
E-mail: office@marvel.bg
Website: www.marvel.bg

CANADA**CAN-AM INSTRUMENTS LTD**

L T P P P
Oakville, Ontario, Canada
Tel: 905-829-0030
E-mail: support@can-am.net
Website: www.can-am.net

CANADA - Oil & Gas in Alberta only**JD INSTRUMENTS, INC.**

P
Houston, Texas 77224-9463
Tel: (713) 468-8087
E-mail: sales@jdinstruments.com
Website: www.jdinstruments.com

CHILE**ARQUIMED S.A.**

L T P P P
Santiago, Chile
Tel: (56) 2/634-6266
E-mail: arquimed@arquimed.cl
Website: www.arquimed.cl

CHINA (P.R.)**AMETEK COMMERCIAL ENTERPRISE (Shanghai) CO., LTD**

L T P P P
Guangzhou, 510075, P.R.China
Tel: (86) 20/3760-0995; -8953
Fax: (86) 20/3760-0548; -8953
E-mail: info@brookfield.com.cn
Website: www.brookfield.com.cn

SINOINSTRUMENT CO., LTD.

L
Guangzhou, P.R. China
Tel: (86) 20/6661-8088
E-mail: dongnan@sinoinstrument.com
Website: www.sinoinstrument.com

PETROLABS TECH LIMITED

P
Beijing, P.R. China
Tel: (86) 10/8766-4678
E-mail: info@petrolabs.com.cn
Website: www.petrolabs.com.cn

SKYLINK FLUID PROCESS TECHNOLOGY (SHANGHAI) CO LTD.

P
Shanghai, P.R. China
Tel: (86) 21-6243-3309
E-mail: warren.zhou@skylink-tec.com
Website: www.skylink-tec.com

COLOMBIA**BIOLABOR SAS**

L T P P
Bogota, Colombia
Tel: (57) 1/694 41 19
E-mail: biolabor@biolabor.net
Website: www.biolabor.net

CZECH REPUBLIC**SYNPO A.S.**

L T P P P
Pardubice Czech Republic
Tel: (420) 46/606-7293
E-mail: instruments@synpo.cz
Website: www.synpo.cz

DENMARK**BUCH & HOLM A/S**

L T P P
Herlev Denmark
Tel: (45) 44/540000
E-mail: b-h@buch-holm.dk
Website: www.buch-holm.dk

SENTEK

P
Copenhagen, Denmark
Tel: (45) 4343-5126
E-mail: sentek@sentek.dk
Website: www.sentek.dk

EGYPT**CTS CHEMICAL & TECHNICAL SERVICES**

L T P P
Cairo, Egypt
Tel: (20) 2/2378-2908
E-mail: ctsegypt@ctsegypt.com
Website: www.ctsegypt.com

EL SALVADOR**ANALITICA SALVADORENA SA DE CV** **LTP**

San Salvador, El Salvador
Tel: (20) 2/2378-2908
E-mail: analisa@analiticasal.com
Website: www.analiticasal.com

ESTONIA/LATVIA/LITHUANIA**G. W. BERG OÜ** **LTP**

Tallinn, Estonia
Tel: (372) 6/505658
E-mail: gwb@gwb.ee
Website: www.gwb.ee

FINLAND**OY G.W. BERG & CO. AB** **LTP**

Vantaa, Finland
Tel: (358) 201/255255
E-mail: gwb@gwb.fi
Website: www.gwb.fi

FRANCE**LABOMAT ESSOR** **LTP**

Saint-Denis, France
Tel: (33) 1/4809-6611
E-mail: info@labomat.com
Website: www.labomat.eu

GERMANY**AMETEK GmbH** **LTPP**

Lorch, Germany
Tel: (49) 7172/927100
E-mail: info@brookfield.eu
Website: www.brookfield.eu

AMETEK Germany GmbH **LTPP**

Schutterwälder Straße 23
D-01458 Ottendorf-Okrilla
Tel: 03 52 05/59 67-0
Fax: 03 52 05/59 67-30
E-mail: brookfield-dresden@ametek.com
Website: www.brookfield.eu

GREECE**ALFA ANALYTICAL INSTRUMENTS** **LTP**

Athens, Greece
Tel: (30) 210/957-3172
E-mail: sales@instruments.gr
Website: www.instruments.gr

HONG KONG**SINOINSTRUMENT CO., LTD.** **LTP**

Guangzhou, P.R. China
Tel: (86) 20/6661-8088
E-mail: dongnan@sinoinstrument.com
Website: www.sinoinstrument.com

HUNGARY**SZIKKTI LABOR LTD.** **LTPP**

Budapest, Hungary
Tel: (36) 1/388-8752
E-mail: szikktilaborkft@t-online.hu
Website: www.szikktilaborkft.hu

VITÁLIS KERESKEDELMI kft. **LTP**

Budapest, Hungary
Tel: (36) 1/355-4106
E-mail: info@vitaliskft.com
Website: www.vitaliskft.com

INDIA**BRK INSTRUMENTS INDIA LLP** **LTPP**

Thane, India
Tel: (91) 22/6614-1666
E-mail: info@brkindia.net
Website: www.brkindia.net

INDONESIA**PT. TRANSINDOTAMA SINAR PERKASA** **LTPP**

Jakarta, Indonesia
Tel: (62) 21/45840670
E-mail: transindotama@transindotama.com
Website: www.transindotama.com

IRELAND**LAB UNLIMITED - CARL STUART GROUP** **LTP**

Dublin, Ireland
Tel: (353) 1/452-3432
E-mail: brookfield@labunlimited.com
Website: www.labunlimited.com

FULLBROOK SYSTEMS LIMITED **P**

Herts, England
Tel: (353) 1/442-876777
E-mail: sales@fullbrook.com
Website: www.fullbrook.com

ISRAEL**AGENTEK (1987) LTD.** **LTPP**

Tel-Aviv, Israel
Tel: (972) 3/649-3111
E-mail: sales2@agentek.co.il
Website: www.agentek.co.il

ITALY**GENERALCONTROL S.P.A.** **P**

Milano, Italy
Tel: (39) 02/3801-1111
E-mail: vendita@generalcontrol.it
Website: www.generalcontrol.it

URAI SPA **LTP**

ASSAGO (Milano), Italy
Tel: (39) 02/892-399.1
E-mail: ambrogio.villa@urai.it
Website: www.urai.it

JAPAN**EKO INSTRUMENTS CO., LTD.** **LTP**

Tokyo, Japan
Tel: (81) 3/3469-6715
E-mail: info@eko.co.jp
Website: www.eko.co.jp

JAPAN MACHINERY COMPANY **P**

Tokyo, Japan
Tel: (81) 3/3573-5421
E-mail: sales@japanmachinery.com
Website: www.japanmachinery.com

JORDAN**PETRA SCIENTIFIC TECHNOLOGIES** **LTP**

Amman, Jordan
Tel: (962) 6/420-1920
E-mail: petrarec@go.com.jo

KOREA**HWASHIN INSTRUMENT CO., LTD.** **LTP**

Seoul, Korea
Tel: (82) 2/3450-5605
E-mail: mail@hwasin.net
Website: www.hwasin.net

JONGRO INDUSTRIAL CO., LTD. **LTP**

Seoul, Korea
Tel: (82) 2/2297-9900
E-mail: jongro@jri.co.kr
Website: www.jri.co.kr

JINWOO HI-TECH CO. LTD. **P**

Seoul, Korea
Tel: (82) 2/511-0374
E-mail: webmaster@jwhitech.com
Website: www.jwhitech.com

LATVIA/LITHUANIA**G. W. BERG OÜ** **LTP**

Tallinn, Estonia
Tel: (372) 6/505658
E-mail: gwb@gwb.ee
Website: www.gwb.ee

MALAYSIA**MECOMB MALAYSIA SDN. BHD.** **LTP**

Petaling Jaya, Malaysia
Tel: (60) 3/7784-3422
E-mail: brookfield@simedarby.com
Website: www.mecomb.com

MEXICO**EL CRISOL, S.A. DE C.V.** **LTP**

Mexico D.F., Mexico
Tel: (52) 55/5264-5500
E-mail: ventas@elcrisol.com.mx
Website: www.elcrisol.com.mx

EQUIPAR, S.A. DE C.V. **LTP**

Mexico, D.F., Mexico
Tel: (52) 55/5420-9901
E-mail: equipar@equipar.com.mx
Website: www.equipar.com.mx

REACTIVOS Y EQUIPO, S.A. DE C.V. **LTP**

Monterrey, Nuevo Leon, Mexico
Tel: (81) 8333 6691
E-Mail: info@reactivosyequipos.com.mx
Website: www.reactivosyequipos.com.mx

MEXICO, ECUADOR, PANAMA**GRUPO MAGNACOLOR, S.A. DE C.V.** **P**

Atizapan, Edo. De Mexico
Tel: (52) 55/5308-0941
E-mail: info@grupomagnacolor.com
Website: www.grupomagnacolor.com

NETHERLANDS**BENELUX SCIENTIFIC BV** **LTP**

Ochten, Netherlands
Tel: (31) 344/655 556
E-mail: info@benelux-scientific.nl
Website: www.benelux-scientific.nl

ELSCOLAB B.V. **P**

Terschuur, Utrecht/Netherlands
Tel: (31) 342 42 60 80
E-mail: main@elscolab.nl
Website: www.elscolab.nl

NEW ZEALAND**THERMO FISHER SCIENTIFIC** **LTPP**

Auckland, New Zealand
Tel: (64) 9/980-6753; 0800 933 966
E-mail: nzinfo@thermofisher.com
Website: www.thermofisher.co.nz

NORWAY**NERLIENS MESZANSKY AS** **LTPP**

Oslo, Norway
Tel: (47) 22/666500
E-mail: info@nmas.no
Website: www.nmas.no

PAKISTAN**RAYS TECHNOLOGIES** **LTP**

Lahore, Pakistan
Tel: (92) 42/35753903
E-mail: info@raystechno.com
Website: www.raystechno.com

PARAGUAY**ALDENOR SA** **LTP**

Asuncion, Uruguay
Tel: (598) 29169857
E-mail: info@aldenor.com.uy
Website: www.aldenor.com.uy

PERU**ARSA REPRESENTACIONES** **LTP**

Lima, Peru
Tel: (51) 1/4221167
E-mail: ventas@arsarep.com.pe
Website: www.arsarep.com.pe

PHILIPPINES**GOLDEN BAT (FAR EAST) INC.** **LTP**

Quezon City, Philippines
Tel: (63) 2/521-9140
E-mail: gbat_acctg@yahoo.com.ph
Website: www.goldenbat.ph

POLAND**LABO PLUS LTD.** **LTP**

Warszawa, Poland
Tel: (48) 22/646-7727
E-mail: laboplus@laboplus.pl
Website: www.laboplus.pl

PORTUGAL**SOQUÍMICA** **LTP**

Lisboa Porto, Portugal
Tel: (351) 21/711 9300
E-mail: soquimica@soquimica.pt
Website: www.soquimica.pt

PUERTO RICO**PUERTO RICO PROCESS TECHNOLOGY, INC.** **LTP**

Fajardo, PR
Tel: (787) 801-4483
E-mail: jgwt@coqui.net

ROMANIA**MULTI LAB SRL** **LTPP**

Bucharest, Romania
Tel: (40) 21/312-7144 / 45
E-mail: contact@multilab.ro
Website: www.multilab.ro

RUSSIA**AVRORA LTD.** **LTP**

Moscow, Russia
Tel: (7) 495 258-8305
E-mail: avrora@com2com.ru
Website: www.viscometer.ru

ARGOSY TECHNOLOGIES LTD. **P**

Moscow, Russia
Tel: (7) 095 510-6236
E-mail: moscow@argosy-tech.ru
Website: www.argosy-tech.ru

SAUDI ARABIA**K. I. ABDULKADIR & PARTNERS CO. LTD.** **LTP**

Jeddah, Saudi Arabia
Tel: (966) 12/640-5846
E-mail: info@kiaksa.com
Website: www.kiaksa.com

NAIZAK GLOBAL ENG. SYSTEMS **P**

Al-Khobar, Saudi Arabia
Tel: (966) 13 8989577
E-mail: sigedaap@naizak.com
Website: www.naizak.com

SERBIA, MONTENEGRO**SUPERLAB** **LTP**

Novi Beograd, Serbia
Tel: (381) 11/222-2222
E-mail: superlab@super-lab.com
Website: www.super-lab.com

SINGAPORE**MECOMB SINGAPORE LIMITED** **LTP**

Singapore
Tel: (65) 6572-1200
E-mail: enquiry.msl@simedarby.com.sg
Website: www.simedarbyenergyutilities.com

PRECISION CONTROL PTE. LTD. **P**

Singapore, Singapore
Tel: (65) 6285-3011
E-mail: sales@pcsin.com.sg
Website: www.precisioncontrol.com.sg

SLOVAK REPUBLIC

ECOTEST, s.r.o. **L T P**
Topolcany, Slovak Republic
Tel: (421) 38/532-0171
E-mail: ecotest@isternet.sk
Website: www.ecotest.sk

SLOVENIA/CROATIA/ BOSNIA-HERZEGOVINA

LABSYS, D.O.O. **L T P**
Ljubljana-LG, Slovenia
Tel: (386) 1/286-2330
E-mail: labsys@labsys.si
Website: www.labsys.si

SOUTH AFRICA

**MONITORING & CONTROL
LABORATORIES (PTY) LTD.** **L T P**
Johannesburg, South Africa
Tel: (27) 11/608-4664
E-mail: sales@moncon.co.za
Website: www.moncon.co.za

**WIRSAM SCIENTIFIC & PRECISION
EQUIPMENT (PTY) LTD.** **P**
Johannesburg, South Africa
Tel: (27) 11-482 1060
E-mail: wirsamjb@wirsam.com
Website: www.wirsam.com

SPAIN

INSTRUMENTACION ANALITICA, SA
L T P
Barcelona, Spain
Tel: (34) 93 478 71 61
E-mail: barcelona@instru.es
Website: www.instru.es

SRI LANKA

HEMSONS INTERNATIONAL (PTE) LTD
L T P
Colombo, Sri Lanka
Tel: (94) 11/232-3308
E-mail: hemasl@hemsons.lk
Website: www.hemsons.lk

SWEDEN

CHEMICAL INSTRUMENTS AB **L T P**
Sollentuna, Sweden
Tel: (46) 8/5448-1260
E-mail: info@ciab.se
Website: www.ciab.se

TEAMATOR AB **P**
Helsingborg, Sweden
Tel: (46) 42-250357
E-mail: info@teamator.com
Website: www.teamator.com

SWITZERLAND

HUNTER & CAPREZ AG **L T P**
Zumikon, Switzerland
Tel: (41) 44/918-0808
E-mail: mail@huntercaprez.com
Website: www.huntercaprez.com

TAIWAN

TODAY'S INSTRUMENTS CO., LTD.
L T P
New Taipei City, Taiwan, R.O.C.
Tel: (886) 2/2603-2311
E-mail: todays@todays.com.tw
Website: www.todays.com.tw

THAILAND

**PRECISION CONTROL (THAILAND) Co.
LTD.** **P**
Bangkok, Thailand
Tel: (66) 2/910-5280
E-mail: sales@pc-thai.com
Website: www.pc-thai.com

SCIENTIFIC PROMOTION CO., LTD.
L T P
Bangkok, Thailand
Tel: (66) 2/185-4333
E-mail: marketing@spcgroup.co.th
Website: www.spcgroup.co.th

TURKEY

ARIF SALTUK LTD. STI. **P**
Istanbul, Turkey
Tel: (90) 212/231-8893
E-mail: arifsaltuk@superonline.com
Website: www.arifsaltuk.com

SEM BIO TEKNOLOJI VE TICARET A.S.
L T P
Istanbul, Turkey
Tel: (90) 216/325-7836
E-mail: info@sembio.com.tr
Website: www.sembio.com.tr

UKRAINE

TEC ENGINEERING LTD. **L T P**
Kiev, Ukraine
Tel: (380) 44/496-2690
E-mail: office@tec.com.ua
Website: www.tec.com.ua

UNITED ARAB EMIRATES, OMAN, QATAR, KUWAIT, YEMEN, BAHRAIN

VENKTRON ELECTRONICS L.L.C.
L T P
Dubai, United Arab Emirates
Tel: (971) 4/8817213
E-mail: venk@eim.ae
Website: www.venktron.com

UNITED KINGDOM

AMETEK (GB) LIMITED **L T P**
Harlow, Essex, England
Tel: (44) 1279/451774
E-mail: sales@brookfield.co.uk
Website: www.brookfield.co.uk

FULLBROOK SYSTEMS LIMITED **P**
Herts, England
Tel: (44) 1-442-876777
E-mail: sales@fullbrook.com
Website: www.fullbrooksystems.co.uk

URUGUAY

ALDENOR SA **L T P**
Montevideo, Uruguay
Tel: (598) 29169857
E-mail: info@aldenor.com.uy
Website: www.aldenor.com.uy

VIETNAM

RONG TIEN CO., LTD **L T P**
Ho Chi Minh City, Vietnam
Tel: (84) 8/3816-4708
E-mail: rongtien@rongtien.com
Website: www.rongtien.com

AMETEK Brookfield Regional Offices

AMETEK (GB) Limited
Brookfield Technical Centre
1 Stadium Way
Harlow, Essex CM19 5GX, England
Tel: 1279/451774
Fax: 1279/451775
E-mail: uk-har.sales@ametek.com
Website: www.brookfield.co.uk

AMETEK GmbH
Hauptstrasse 18
D-73547 Lorch, Germany
Tel: 7172/927100
Fax: 7172/927105
E-mail: brookfield.de@ametek.com
Website: www.brookfield.eu

AMETEK Germany GmbH
Hugo-Junkers-Ring 5
Haus 107 W
01109 Dresden
Tel: 03 51 88/96 81-0
E-mail: sven.osburg@ametek.com
Website: www.brookfield.eu

**AMETEK Commercial
Enterprise (Shanghai) Co., Ltd**
Suite 905-906, South Tower, Suntec Plaza, 193
Guangzhou Da Dao Bei Road
Yuexiu District Guangzhou, Guangzhou, P.R.C.
510075
Tel: (86) 20/3760-0995
Fax: (86) 20/3760-0548
E-mail: brookfield-china.sales@ametek.com
Website: www.brookfield.com.cn

**AMETEK Brookfield
Midwest Regional Office**
8 North Maple Street
Mt. Prospect, IL 60056 USA
Tel: (847) 368-8472
E-mail: davidc.larson@ametek.com
Website: www.belusa.com



AMETEK Brookfield

11 Commerce Boulevard, Middleboro, MA 02346-1031 USA

T (800) 628 8139 or (508) 946 6200

F (508) 946 6262

www.brookfieldengineering.com