

BUCH  HOLM



Edition 4

Your Lab is our Mission!

Lab Instruments and Comsumables



WE KNOW WHAT IT TAKES...

“ Your lab is our mission and after more than eight decades in the market as suppliers for Danish and Swedish laboratories we at Buch & Holm are still proud to say: **We know what it takes.** ”



SERVICE

We are an authorised service centre for a great number of manufacturers. We offer maintenance and service contracts carried out by trained technicians using certified equipment.



PRODUCT SPECIALISTS

Every day our talented and dedicated employees make an effort to keep their fingers on the pulse. We always strive to acquire the knowledge and skills needed to provide you with the right solution.



SEMINARS

We offer a number of different seminars, which are all for free. Our seminars aim to convey knowledge at a high professional level. You will find the seminars at our web page. Please join and learn something!

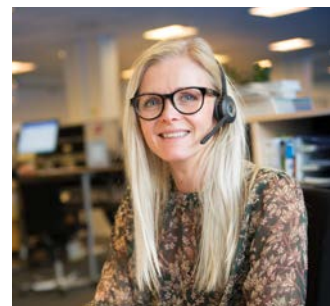

CUSTOMER SUPPORT

When you call us, one of our skilled employees from Customer Support will take your call. Please do not hesitate to contact us by email b-h@buch-holm.dk or by phone +45 44 54 00 00.



Detailed table of contents	I
Alphabetical index	A 1
General laboratory consumables	1
Occupational safety, Security	49
Analytical measurement and testing.....	72
Stirring, Shaking, Mixing	84
Sample preparation	97
Distillation, separation, filtration.....	100
Heating and cooling technology.....	118
Liquid Handling.....	127
Vacuum technology, Drying, Dry storage.....	144
Optical instruments and Microscopes	149
Cleaning and sterilisation	156
Environmental-, soil-, water-, food analysis	166
Life Sciences.....	168
Chromatography.....	179

Imprint

Published by:

Lab Logistics Group GmbH
Meckenheim, Germany

Editor:

Lab Logistics Group GmbH, Germany

Printing:

KonradinHeckel
Konradin Druck GmbH, Nürnberg

Software:

Wisssoft GmbH, Schifferstadt, Germany

Design:

Lab Logistics Group GmbH, Germany
Stock Photos by Shutterstock.com, Fotolia.de, istockphoto.com

© Copyright 2018, Lab Logistics Group GmbH

Copying of information or data, especially all or part of the text and illustrations is only allowed if LLG has given written agreement to this in advance. Existing rights of trademarks, patents, registrations etc. are indicated and acknowledged. A missing mark does not mean that there are no protective rights existing.

Illustrations are only representative of the products supplied and may show accessories and associated items which are not included within the scope of supply. Technical specifications are subject to change.

Copies: 32,050

Published: 2018

Abbreviation key:

PK = packaging unit
E & OE = Errors and omissions excepted

Liability, information on products and rights belonging to third parties

Lab Logistics Group GmbH and the dealer who uses this catalogue accept no liability for the suitability of an item listed in the catalogue for a specific application. The responsibility for the suitability of an item for a specific application lies with the user. Please ask your dealer for advice.

Information contained within the catalogue concerning items of personal protective equipment are of general nature only and do not recommend any specific application. To determine whether a product meets the safety requirements of a specific application, the user must assess the technical data sheets/safety data sheets of the manufacturer/supplier indicated.

All product listings have been researched and presented in co-operation with the respective supplier.

Every effort has been made to ensure that data, descriptions and prices given within this catalogue were correct at the time of going to press but we accept no liability for any error. We kindly ask you for your understanding.

Your LLG-Partner's Terms and Conditions of Business will apply.

Some products and brands shown in this catalogue may not be available in all countries.

General laboratory consumables	1
Vessels	1
Tools	26
Heating	33
Tubing	35
General laboratory aids	40
Occupational safety, Security	49
Eye protection	49
Breathing protection	52
Gloves	54
Protective clothing	62
Identification of hazards	64
Waste disposal	65
Transport	67
Furniture	69
Analytical measurement and testing	72
pH-measurement	72
Balances	74
Thermometers	77
Timing	81
Analytical instruments and systems	83
Stirring, Shaking, Mixing	84
Magnetic stirrers / Hotplates	84
Shakers and mixers	91
Sample preparation	97
Sampling	97
Grinding	99
Distillation, separation, filtration	100
Distillation, synthesis	100
Separating, centrifuging	107
Filtration	112
Heating and cooling technology	118
Cooling	118
Heating	122

Contents

Liquid Handling	127
Volumetric apparatus	127
Pipettes	131
Dispensing	140
Titration	142
Vacuum technology, Drying, Dry storage	144
Pumps	144
Vacuum controller	145
Desiccators	145
Optical instruments and Microscopes	149
Optical instruments	149
Microscopy	150
Refractometers	153
Photometers	154
Cleaning and sterilisation	156
Disinfection	156
Cleaning implements	157
Steam sterilisers - Autoclaves	162
Environmental-, soil-, water-, food analysis	166
Sample analysis	166
Life Sciences	168
Genomics	168
Cell Culture	170
Microbiology	172
General Consumables	177
Chromatography	179
Vials	179
NMR/EPR	193
Liquid chromatography	194

2in1 Kits vials	
-screw neck ND11	185
-screw neck ND8	180
-screw neck ND9	183
3in1 Kits vials	
-screw neck ND8	180
- A -	
Absorbents	67
Adapters for expansion and reduction	104
Adhesive tapes	40-41
Aluminium	
-containers, round	46
-containers, square	46
-discs	46
-foil	46
Aprons	62
Arm protectors	63
Aspirator bottles	14
Aspirators	171
Assortment boxes	23
Autoclavable bags	65
Autoclave gloves	61
Automatic burettes	
-class AS	143
-Schilling pattern	142
- B -	
Bags	
-autoclavable	65
-biohazard	65
-disposal	47-48,65
-freezer	47
-homogenizing	98
-sample	48,97-98
-waste	65
Balances	
-compact	74
-precision	74
-weighing brushes	161
Beakers	
-boro 3.3	1
-glass, low form	1
-griffin	1
-multi-purpose	11
Biohazard bags	65
Block heaters	94
Block thermostats	94
Blowballs	143
Boiling stones	
-Type A	103
-Type B	103
Bossheads	
-90°	44
-cast iron	44
-cross	44
-die-cast zinc	44
-stainless steel	44
Bottle carriers	12
Bottle-top dispensers	141-142
Bottles	
-aspirator	14
-burette	143
-gas washing	104
-glass, rolled rim	10
-graduated	17-18
-laboratory	16
-narrow-mouth	18
-sample	98
-square	17
-wash	18
-wash, safety	19
-wash, vented	19

- B -	
Bottles	
-wide mouth, graduated	17
-wide neck	16
-wide-mouth, plastic	17
-with screw cap	17
Bouffant caps	63
Bowie & Dick Test Packs	163
Boxes	
-collapsible	13
-display	12
-euronorm	13
-stackable	13
-storage	12
-storage, with lid	13
Breath protection	53
Brush for test tubes	4
Brushes	
-cleaning	160
-hair	161
-natural bristle	160
-red marten hair	161
-weighing	161
Buckets	
-plastic	13
Bulbs	133
Bunsen burners	33
Burettes	
-automatic, class AS	143
-automatic, Schilling pattern	142
-bellows	143
-bottles	143
-clamps	45
-class AS	142
-Schellbach line	142
-with straight stopcock	142
Burners	
-bunsen	33
-gas	33
-gas cartridge	33
-Teclu	33
-tubing	35
- C -	
Cameras, microscopes	150
Cap coders for cryo tubes	118
Caps for vials	
-crimp seals ND11	184
-crimp seals ND13	186
-crimp seals ND20	189-190
-crimp seals ND24	191
-crimp seals ND8	179
-crimping tools	192
-for NMR tubes	193
-headspace seals ND20	190
-plugs	187
-screw bonded ND10	183
-screw bonded ND9	182
-screw seals ND13	186
-screw seals ND15	187
-screw seals ND18	187
-screw seals ND18 magnetic	188
-screw seals ND8	180
-septa ND13	186
-septa ND20	190
-septa ND8	180
-septa ND9	182
-snap caps ND18	188
-snap caps ND22	188
-snap ring ND11	185
-stoppers	190
-thread seals ND9	182

Alphabetical index

- C -		- C -	
Caps		Connectors	
-dropping bottles	19	-threaded tube	104
-for jerricans	15	Containers	
-jars, wide neck	12	-cool	122
-screw	16,18	-sampling	9-10
Carboys	14	-storage	12
Cavity tiles	152	-tamper-evident cap	9
Cell culture plates	170	-transport	12
Cell culture		Controllers	
-flasks	170	-macropipette	132-133
Cells/Optical cells		-pipette	132
-disposable	155	Cool containers	122
-stands	155	Cork rings	101
-storage boxes	155	Cotton	
-VIS-range	155	-applicators	173-174
Cellulose		-wool	159
-stoppers	175	Counters	
-tissues	159	-hand tally	150
-wad	159	Cover slips	151
Cell		Coveralls	63
-counters	150	Crimping tools	192
-disruptors	176	Crucibles	
Centrifuge tubes		-filter, glass	116
-5 ml	177	-porcelain	24
-micro	110	-quartz glass	24
-PP	110-111	Cryo boxes	
-PS	111	-autoclavable	120-121
-racks	7-8	-partition inserts	119-120
-racks, foldable	7	-plastic coated	119-120
-with rim	110	Cryo tubes	118
Centrifuges		Cryo tubes	
-high-speed	109	-floating racks	122
-mini	107-109	-insert cap discs	118
-with timer	108-109	-storage boxes	118-121
Centrifuge		Cryo vials	118
-micro tubes, PP	110	Cryo vials	
-tubes, with rim	111	-cap coders	118
Chairs	70	-floating racks	122
Chemical protection gloves	60	-storage boxes	118
Chemical		Cryogenic	
-binder	67	-apron	62
-sorbents	67	-blocks	121
Clamps		-boxes autoclavable	120
-2-prong	45	-racks	122
-for burette	45	-storage boxes	118-121
-for joint	105	Crystallising dishes	22
-retort	45	Cutters	
Clamp		-tool	30
-with cork	45	-tubing	37
Cleaners		Cuvettes	
-dust remover spray	156	-disposable	155
-technical cleaning cloths	156	-stands	155
Cleaning		-storage boxes	155
-brushes	160	- D -	
-cloths	158	Data loggers	81
-dishwashing	157	Deep-well plates	
-hand towels	159	-384-well	178
-tissues	158	-96-well	178
-tissues for lenses	51	-sealing mats	178
-wipes	157	Desiccators	
-wipes, floor stand	158	-auto dry box	148
Cleansing lotions	62	-discs	145
Clips		-drying agents	148
-conical joint	105	-glass	145
-for joints	105	-PC	146
-for sleeve connections	105	-plates	145
Closure ties	66	-portable	67
Coats, laboratory	62	-vacuum	145-146
Compressors, vacuum pump	144	-vacuum cabinet	147
Condensers		-vacuum, accessories	146
-Dimroth	102	Dimroth condensers	102
-Liebig	102		
-spiral	102		

- D -

Dippers	97
Dishwashing	157
Disinfectant	
-surface	156
-tissues	156
Dispensers	
-bottle-top, fix volume	141
-bottle-top, variable volume	141-142
-gloves	53,59
-hand towels	159
-manual	140
-microscope slides	150
-serial	140
-spectacles	51
-tips, PD	140
Dispensing scoops	32
Display boxes	12
Disposable	
-bouffant caps	63
-cuvettes	155
-dippers	97
-filter units	171
-gloves, latex	54
-gloves, nitrile	55-56,58
-lab coats	62
-Optical cells	155
-overshoes	64
-pasteur pipettes	131
-scalpels	177
-scoops	97
-shoe covers	64
-syringe filters	114-115
-syringes, 3-parts	194
-visitor gowns	62
Disruptors	176
Dissection scissors	29
Draining racks	162
Dropping	
-bottles	19
-funnels	102
Drying ovens	124-125

- E -

Edding markers	42
Electrodes stands	73
Erlenmeyer flasks	
-glass	2
-plastic	2
Evaporating basins	22
Evaporating dishes	22
Evaporating dishes	
-porcelain	25
Exchangeable blocks	94
Extraction thimbles	103
Extractors, soxhlet	103
Eye protection	49-50

- F -

Face	
-visor	52
Film	
-dispenser	48
-sealing	47-48
Filter flasks	117
Filter paper	
-circles	112-113
-folded	112
-glass fibre filters	114
-qualitative	112
-quantitative	113
-sheets	112

- F -

Filter tips	138
Filters	
-bottle-top	171
-glass fibre	114
-glass funnels	116
-inline	115
-syringe filter CA	114
-syringe filter NY	114
-syringe filter PES	115
-syringe filter PTFE	114
-syringe filter PVDF	115
-syringe filter RC	115
Filtration	
-capsules	115
-funnels	20
Fine dust masks	53
Flashlights	30
Flask rings	3,101
Flasks	
-culture	175
-Erlenmeyer, glass	2
-Erlenmeyer, NS joint	101
-filter	117
-flat bottom, NS joint	100
-for rotary evaporators	101
-glass, erlenmeyer	2
-plastic, erlenmeyer	2
-round bottom, NS joint	100
-round bottom, with three necks	100
-round bottom, with two necks	100
-volumetric	129-130
Floor stands for cleaning cloth	158
Forceps	
-assortment	31
-cover glass	32
-dissecting	31
-PMP	32
-stainless steel	31
Fork clamps	105
Funnels	
-Büchner, porcelain	116
-conical joint	21
-dropping funnels	102
-fast filtration	20
-filter	116
-glass	20
-holder	21
-powder	20
-PP	20
-separating, Squibb	103
-stand	21
Furniture	69-71

- G -

Gas washing bottles	104
Gaskets	117
Gas	
-burners	33
-cartridges	33
-lighters	33
Glass	
-fibre papers	114
-wool	194
Gloves	
-chemical protection	60
-cotton	60
-cut protection	61
-dispenser	59
-disposable, latex	54
-disposable, long	57
-disposable, nitrile	55-58
-disposable, powder free	54-58

Alphabetical index

- G -		- L -	
Gloves		Labels	
-heat protection	61	-biohazard	64
-neoprene	60	-hazard GHS	64
-safety, nitrile	60	-removing sprays	41
Graduated pipettes		Lab	
-class AS	131	-chairs	70
-typ 3	131	-coats	62
Grease		-coats, disposable	62
-glass joints	106	-jacks	43
-vacuum, water soluble	106	-notebooks	42
Griffin beakers	1	-stools	69
- H -		Lamps	30
Hair brushes	161	Lens cleaning tissues	51
Half-masks	53	Liebig condensers	102
Hand		Linear shakers	93
-bellows	143	Liquid samplers	97-98
-protection cream	62	Lotions, cleansing	62
-protectors	61	Low temperature thermometers	78
-tally counters	150	- M -	
Hazard labels	64	Macropipette controllers	132-133
Heat protective gloves	61	Magnesia	
Heaters, gas	33	-rods	25
Heating bath liquid	123	-trays	25
Holders for funnels	21	Magnetic stirrers	
Homogenizing bags	98	-complete set	86-88
Hose cutter	37	-multi-position	85
Hotplates		-reaction block	90
-Temperature sensors	88	-Temperature sensors	88
-with stirrer	86-89	-ultra flat	85
HPLC		-with heating	86-89
-columns, with frit	194	-with induction	85
-columns, without frit	194	-with motor	84
-glass wool	194	-without heating	84-85
-quartz wool	194	Magnetic stirring bars	
- I -		-cylindrical	86
Impellers		-retrievers	87
-3-blade	91	Magnifiers	
-4-blade	91	-hand-held	149
In-line filters	115	-illuminated	149
Incinerating boats	25	-precision	149
Incubators	126	-reading	149
Indicator paper		-scale	149
-rolls	72	-table-top	149
-steam	162-163	Magnifying lenses	149
-strips	72	Markers	
Indicator tapes		-diamond-tipped	30
-gas sterilisation	162	-glass	30
-hot air	162	-permanent	42
-steam	162	Measuring cylinders	
Infra-red thermometers	80	-class A, boro 3.3	127
Inoculation loops	174	-class B	128
Instrument		-class B, PP	127-128
-boxes	23	Measuring jugs	1
-tablets	23	Measuring scoops	32
-trays	23	Mediclips	39
Interval timers	82	Melting point instruments	83
- J -		Melting point meters	
Jars		-capillary tubes	83
-glass	12	Micro-spatulas	27
-PE	11	Micro-tubes	
-plastic	10	-racks	6-7
-PP	9-10	-stands	6-7
Jerrycans	15	Micro-tube	
Joint clips	105	-stands	6

- M -

Microscope slides	
-dispenser	150
-folders	151-152
-folders, Munich	152
-mailers	151
-Superfrost	150
-trays	151-152
Microscopes	150
Mini-incubators	126
Mixing cylinders	128
Molecular model systems	42
Mortars	99
Mortars	
-porcelain	99
Multi-purpose tools	30

- N -

Needles containers	66
NMR	
-racks	193
-tube caps	193
-tubes	193
Notebooks	42
NS jointed	
-Erlenmeyer flasks	101
-flat bottom flasks	100
-round bottom flasks	100
-round bottom flasks, 2 necks	100
-round bottom flasks, 3 necks	100

- O -

Oil binder	67
Orbital shakers	93
Orsat blowballs	143
Ovens	
-drying	124-125
-heating	124-125
-universal	124-125
-with forced convection	124-125
Overalls	63
Overhead shakers	95
Overhead stirrers	91
Overshoes	64
Oversleeves	63

- P -

Palette knives	28
Paper	
-indicator	72
-surface protection	47
PARAFILM® M	48
Pasteur pipettes	131
PCR	
-adhesive film	169
-foil	169
-plates, 96-well	169
-racks	169
-tubes	168
-tubes, strips	168
Permanent markers	42
Pestles	
-agate	99
-micro	176
-porcelain	99
Petri dishes	
-glass	172
-holders	172
-PS	172
Photometers, hand-held	166

- P -

pH	
-meters, portable	73
-papers	72
-testers	73
Pipette controllers	132-133
Pipette tips	
-empty racks	139
-filter	138
-low retention	138-139
-refill system	139
-standard	138
Pipettes	
-bulbs	133
-digital microlitre	135-137
-electrical pump	132
-horizontal stand	134
-pasteur, disposable	131
-pasteur, glass	131
-racks	137
-safety bulb	133
-serological	132
-single channel microlitre	135-137
-stands	137
-stepper	140
-teats	133
-tips, PD	140
-variable boxes	134
-variable volume	135-137
-vertical stand	134
Piston pumps	144
Plastic	
-buckets	13
-pitchers	1
Plates	
-cell culture	170
-deep-well	178
-storage	178
Platform rockers	93
Pocket	
-lamps	30
-refractometers	153
-thermometers	79-80
Porcelain	
-crucibles	24
-evaporating basins	22
-evaporating dishes	22
-incinerating boats	25
Portable pH meters	73
Pouches	162-165
Powder spatulas	28
Power failure detector	122
Precision balances	74
Propeller stirrers	91
Propeller stirrers	
-paddle, 3 holes	91
Protection	
-aprons	62
-overalls	63
-overshoes	64
-skin protection cream	62
-sleeves	63
Protective clothing	63
Protective	
-face visor	52
- Q -	
Quartz wool	194
Quick-lock binders	66

Alphabetical index

- R -	- S -
Racks	Scissors
-floating racks 122	-surgical 29
-for centrifuge tubes 7-8	Scoops
-for chromatography vials 192	-dispensing 32
-for cuvettes 155	-disposable 97
-for micro-tubes 6-7	-sampling 97
-for microlitre pipettes 137	Screw caps
-for test tubes, PP 8	-for narrow-neck bottles 18
-for test tubes, steel 9	-for wide-neck bottles 16
-tips, refill system 139	Sealer 165
-wire, for test tubes 8-9	Sealing
Reagent reservoirs 140	-film 47-48
Refractometers	-film, dispenser 48
-digital 153	-mats, deep-well plates 178
-hand-held 153	Seats 69
Repeater pipettes 140	Sedimentation cones
Reservoirs, for reagents 140	-glass 167
Retort	-holders 167
-clamps 45	-Imhoff 167
-stand bases 43	-SAN 167
Rings	Serological pipettes 132
-for round bottom flasks 101	Shakers
-stabilising, lead 3	-disruptor 176
Rods	-linear 93
-magnesia 25	-microtiter 94
-stirring 28	-orbital 93
-support 43	-overhead 95
Roller mixers 96	-rocking 93
Roller	-roller 95
-steps 71	-rotator 95
Rotator mixers 95	-tumbling 93
Rubber	-vertical 95
-pipette balls 133	-vortexer 91
-spacers 117	Sharps containers 66
-stoppers 4-5	Shoe covers 64
- S -	Skin protection 62
Safety	Sleeves
-equipment storage boxes 53	-cone joint 106
-eyeshields 49-50	-stabilising, lead 3
-eyeshields, panoramic 50	-with ribs 106
-face masks 52-53	Slicers 30
-face shields 52	Soakers 47
-face visors 52	Sorbents 67
-fine-dust masks 53	Spatulas
-gloves 61	-double-ended 27
-overshoes 64	-Drigalski 173
-pipette balls 133	-macro 27
-pipette bulbs 133	-micro 27
-protective visors 52	-powder 28
-sharp containers 66	-round grooved 26
-spectacles 49-50	-spoons 26
-spectacles, dispenser 51	Spectrophotometers
-suction systems 171	-accessories 154
-visitors eyeshields 49	-cells 155
Sample	-single beam 154
-bags 97-98	Spiral condensers 102
-containers 9-10	Spoons
-dishes 76	-double ended 26
Sampling	-multi-purpose 26
-bottles 98	-sampling 27
-dippers 97	-short form 26
-scoops 97	-spatula 26-27
-spoons 27	-spatula, macro 27
-transport 98	-spatula, micro 27
-tubes 98	Spreaders 174
Scalpels 177	Staining
Scissors	-jars 152
-stainless steel 29	-plates 152
-steel 29	-troughs 152
	Standing aids 71
	Stands
	-for cuvettes 155
	-for electrodes 73

- S -

Stands	
-for Optical cells	155
-for pipettes	137
-for sedimentation cones	167
-for waste bags	65
-tripod	34
Stepper pipettes	140
Steps	71
Sterilisation	
-Bowie & Dick test	163
-indicator strips	162-163
-indicator tapes	162
-pouches	163-165
-pouches sealer	165
-reels	162-165
-sealer	165
Stirrers	
-magnetic	84-89
-overhead	91
-Temperature sensors	88
Stirring rods	28
Stirring shafts	
-3-blade	91
-4-blade	91
-paddle, 3 holes	91
Stools	69,71
Stoppers	
-cellulose	175
-cork	5
-glass	104
-hollow	104,13
-NS	104,13
-PP	130
-rubber	4
-silicone	5
-test tubes	4
-turn-over flange	5
Storage	
-boxes, microscope slides	151-152
-boxes, microtubes	121
-boxes, vials	192
-plates, deep-well	178
Straight scissors	29
Suction systems	171
Support rings	43
Surface protector	
-paper	47
Surgical face masks	52
Swabs	
-cotton applicator	174
-dry	173
-plain	173
Syringe filters	
-CA membrane	114
-NY membrane	114
-PES membrane	115
-PTFE membrane	114
-PVDF membrane	115
-RC membrane	115
Syringes	
-all-glass	194
Staining	
-disposable	194
- T -	
Taps for aspirator bottles	14
Teats	133
Teclu burners	33
Temperature	
-blocks	121
-strips	78
Test papers, pH	72

- T -

Test papers	
-pH	72
Test tubes racks	
-foldable	7
-PP	7-8
-self-aligning	9
-steel	9
-wire	8-9
-wooden	9
Test tubes	
-brushes	4
-cleaner	4
-glass	3
-holders	9
-PP	111
-PS	111
-rimless	3
-round bottom	3
-stoppers	4-5
Thermometers	
-digital	79-80
-Exact-Temp	78
-general purpose	77
-indoor/outdoor	79
-infra-red	80
-low Temperature	78
-Min/Max	79
-pocket	79-80
-precision	78
-refrigerator	79
-waterproof	80
Thermomixers	
-exchangeable blocks	94
-instruments	94
Thermoshakers	94
Ties for bags	66
Timers	
-4-channel	81
-countdown	82
-dual short period	82
-electronic	81-82
-interval	82
-short period	82
Tips	
-filter	138
-for stepper	140
-low retention	138-139
-refill system	139
-standard	138
Tissues	
-cleaning	157-158
-dispenser bin	156
-hand towels	159
Tongs	
-for basins	34
-for beakers	34
-for crucibles	34
-for flasks	34
Tongue depressors	28
Tools	30
Torches	30
Transport	
-boxes, collapsible	13
-boxes, euronorm	13
-microscope slides	151-152
-trolleys	68
-tubes	98
Trays	23
Tripod stands	34
Trolleys	68
Tube mixers	91-92,95
Tubes	
-capillary, melting point	83

Alphabetical index

- T -	- V -
Tubes	Vials
-centrifuge, 5ml. 177	-shell ND8. 187
-centrifuge, PP 110-111	-short thread ND9 181,184
-centrifuge, PS 111	-snap cap N22. 188
-centrifuge, round bottom. 110	-snap cap ND18. 188
-centrifuge, with rim 110-111	-snap ring ND11 185
-cryogenic. 118	-storage boxes 192
-microcentrifuge 110	Visitor gowns 62
-NMR 193	Volumetric flasks
-test, PP 111	-class A, boro 3.3 129
-test, PS 111	-class A, PMP 129
Tubing	-class B, PP. 130
-adapters, L-shape. 38	-trapezoidal shape 129
-clamps 39	Volumetric pipettes
-clamps, curved 39	-1 mark 131
-clips 40	-class AS, glass 131
-connectors. 38	Vortexer mixers 91-92
-connectors, 3-way 38	
-connectors, 4-way 38	- W -
-connectors, plug type 38	Wash bottles
-gas burners 35	-narrow-mouth 18
-norprene 37	-safety 19
-PFA. 37	-safety, vented 19
-PVC 37	-safety, with valve 19
-re-inforced 36	Waste
-rubber. 35	-bags 65
-silicone 36	-bins 66
-vacuum 35	-containers 66
Tumbling shakers 93	Watch glasses
Tweezers 31	-glass. 21
	-PP 21
- U -	Water jet pumps 144
Ultrasonic cleaners 51	Water sampling 97-98
Undergloves 60	Weighing boats
Urine cups 11	-aluminium 76
USB Hand-held microscopes. 150	-antistatic 76
	-hexagonal 76
- V -	-Kjeldahl. 75
Vacuum	-square 76
-aspiration systems 171	Weighing bottles
-desiccating cabinets 147	-glass. 75
-desiccators 145-146	Weighing brushes 161
-grease. 106	Weighing dishes
-measuring instruments 145	-aluminium 76
-pumps. 144	-PS 76
-tubing. 35	Weighing paper. 75
Valves	Weighing scoops
-greases 106	-glass. 75
-non-return. 39	-porcelain 75
Vertical shakers 95	-stainless steel 75
Vials	Winchester bottles 18
-crimp neck headspace ND20 189	Wire gauzes 34
-crimp neck ND11 184	
-crimp neck ND13 186	
-crimp neck ND20 192	
-crimp neck ND8 179	
-crimping tools 192	
-micro-inserts ND10. 183	
-micro-inserts ND11. 185	
-micro-inserts ND8 179	
-micro-inserts ND9 181	
-racks. 192	
-screw neck ND10 183	
-screw neck ND13 186	
-screw neck ND15 187	
-screw neck ND18. 187-188	
-screw neck ND24 191	
-screw neck ND8. 179	
-screw neck ND9. 181,184	
-shell ND12. 187	
-shell ND15. 187	

1 Beakers, Borosilicate glass 3.3, low form

DIN 12 331. ISO 3819. With approximate graduations and spout.

Capacity	Ext. diam.	Height	PK	Cat. No.
ml	mm	mm		
5*	22	30	10	9.013 905
10*	26	35	10	9.013 906
25*	34	50	10	9.013 900
50	42	60	10	9.013 901
100	50	70	10	9.013 902
150	60	80	10	9.013 903
250	70	95	10	9.013 904
400	80	110	10	9.013 910
600	90	125	10	9.013 911
800	100	135	10	9.013 912
1000	105	145	10	9.013 913
2000	130	185	1	6.289 994
3000	150	210	1	6.270 090
5000	170	270	1	6.280 298

*without graduation



2 Beakers, Borosilicate glass 3.3, tall form

DIN 12 331. ISO 3819. With approximate graduations and spout.

Capacity	Ext. diam.	Height	PK	Cat. No.
ml	mm	mm		
25*	30	55	10	9.013 924
50	38	70	10	9.013 925
100	48	80	10	9.013 920
150	54	95	10	9.013 921
250	60	120	10	9.013 922
400	70	130	10	9.013 923
600	80	150	10	9.013 930
800	90	175	10	9.013 931
1000	95	180	10	9.013 932
2000	120	240	10	6.270 117

*without graduation



3 LLG-Griffin beakers, PP

According to ISO 7056. With spout and printed blue graduations.

Capacity	Grad.	Diam.	Height	PK	Cat. No.
ml	ml	mm	mm		
25	5	32	47	2	9.013 670
50	10	39	60	2	9.013 671
100	10	50	70	2	9.013 672
250	25	67	93	2	9.013 673
500	50	88	119	2	9.013 674
1000	50	109	147	2	9.013 675
2000	100	133	184	1	9.013 676



4 LLG-Measuring jugs, PP

According to ISO 7056. With spout and printed blue graduations. Stackable.

Capacity	Grad.	Diam.	Height	PK	Cat. No.
ml	ml	mm	mm		
250	5	75	115	2	9.013 680
500	10	100	137	2	9.013 681
1000	10	125	167	2	9.013 682
2000	20	148	217	1	9.013 683
3000	25	170	244	1	9.013 684



Vessels/Flasks



1 Erlenmeyer flasks, Borosilicate glass 3.3, narrow neck

DIN ISO 1773. With graduations and beaded rim.

Capacity	Neck diam.	Bottom diam.	Height	PK	Cat. No.
ml	mm	mm	mm		
25	22	42	70	10	9.141 079
50	22	51	90	10	9.141 080
100	22	64	105	10	9.141 081
200	34	79	135	10	9.141 085
250	34	85	145	10	9.141 082
300	34	87	160	10	9.141 086
500	34	105	180	10	9.141 083
1000	42	131	220	10	9.141 084
2000	50	166	280	10	6.270 089
3000	50	187	310	1	6.270 118
5000	50	220	365	1	6.270 119

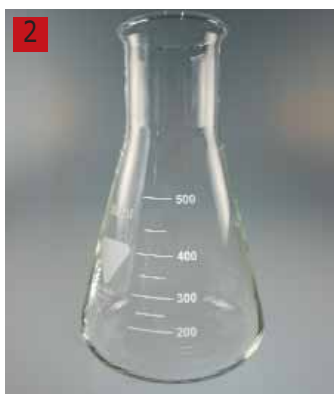

2 Erlenmeyer flasks, Borosilicate glass 3.3, wide neck

DIN ISO 24450. With graduations and beaded rim.

Capacity	Neck diam.	Bottom diam.	Height	PK	Cat. No.
ml	mm	mm	mm		
25	31	43	70	10	9.141 186
50	34	51	85	10	9.141 180
100	34	64	105	10	9.141 181
200	50	79	131	10	9.141 187
250	50	85	140	10	9.141 182
300	50	87	156	10	9.141 183
500	50	105	175	10	9.141 184
1000	50	131	220	10	9.141 185
2000	69	166	280	10	6.270 181
3000	69	187	310	1	6.281 125



3 Erlenmeyer flasks, borosilicate glass 3.3, with screw neck

Borosilicate glass 3.3. Resistant to heat and almost all chemicals. Ideal for contamination free storage of culture specimen and media. Inscriptions are in white enamel which is specially designed for glass use. Autoclavable flasks and PP screw caps are resistant up to 121 °C.

Capacity	Height	Neck thread	PK	Cat. No.
ml	mm	GL		
100	110	32	1	9.141 100
250	145	32	1	9.141 101
500	180	32	1	6.242 393
1000	225	32	1	9.141 102



4 Erlenmeyer flasks with screw neck, PP

Highly transparent, wide-mouth, can also be used with NS stoppers (not included).

Suitable for storage and cultivation of cell cultures.

Safer than glass flasks for use in incubator shakers due to the break resistance of plastic. Suitable for microwaves.

To preserve markings, do not clean at temperatures exceeding 60 °C

Food-safe product according to EC Directive No. 10/2011.

Capacity	Grad.	stopper size	Neck thread	PK	Cat. No.
ml	ml		GL		
50	10	34/35	40	1	9.141 381
100	20	34/35	40	1	9.141 382
250	50	45/40	52	1	9.141 383
500	100	45/40	52	1	9.141 384
1000	200	45/40	52	1	9.141 385

1 Stabilizing/Weighting rings, lead

LAB-Rings to stabilise glassware and plasticware on shakers or to immerse in water baths. Vinyl-coated lead rings will not mark or scratch benchtops and labware.

Type	For flasks ml	Int. diam. mm	PK	Cat. No.
O-Shape	5 - 10	18	1	7.072 085
O-Shape	125 - 500	48	1	6.243 010
O-Shape	250 - 1000	51	1	6.242 742
O-Shape	500 - 2000	57	1	6.243 011
O-Shape	1000 - 4000	70	1	7.054 161
C-Shape	125 - 500	42	1	9.149 902
C-Shape	250 - 1000	51	1	9.149 905
C-Shape	500 - 2000	54	1	9.149 906
C-Shape	1000 - 4000	66	1	9.149 907



2 LLG-Test tubes, Fiolax® glass

Round bottom test tubes made of high quality Fiolax® glass with beaded rim.

Diam. mm	Height mm	Wall thickness mm	PK	Cat. No.
8	70	0.5	100	7.190 001
10	100	0.5	100	6.234 026
12	75	0.5	100	7.613 795
12	100	0.5	100	7.190 011
14	130	0.5	100	7.606 374
16	130	0.6	100	7.606 375
16	160	0.6	100	7.190 021
18	180	0.6	100	7.190 023
20	180	0.6	100	7.190 028



3 Test tubes, Soda-lime glass, heavy wall

Rimless, with round bottom (0.7 to 1.0 mm wall thickness).

Diam. mm	Height mm	Wall thickness mm	PK	Cat. No.
12	75	0.7 ±0.04	250	6.258 821
12	100	0.7 ±0.04	250	6.258 822
16*	100	0.8 ±0.04	250	6.258 825
16*	160	0.8 ±0.04	250	6.258 826
18*	180	1.0 ±0.05	250	6.258 827

* Suitable for Kapsenberg caps.



4 LLG-Test tubes, soda-lime glass

Test tubes with round bottom. Hydrolytic resistance: Class HGB 3 acc. to ISO 719, Type III acc. to C - USP.

Diam. mm	Height mm	Wall thickness mm	Rim	PK	Cat. No.
12	75	0.8	smooth rim	100	9.400 009
16	100	0.8	smooth rim	100	9.400 022
14	130	0.8	smooth rim	100	9.400 030
16	160	0.8	smooth rim	100	9.400 040
18	180	0.8	smooth rim	100	9.400 050
10	100	0.5	beaded rim	100	6.801 073
12	100	0.5	beaded rim	100	7.607 198
16	130	0.6	beaded rim	100	6.800 382
16	160	0.6	beaded rim	100	7.600 405
25	150	0.9	beaded rim	50	6.800 621
30	200	0.9	beaded rim	50	7.600 324



Test tube cleaners, rubber

For removing heavy soiling from test tubes by scraping. With 5 mm boring for rod.

Form	Width mm	PK	Cat. No.
Rubber Spatulas (grey)	35	1	9.190 902 2
Rod-shaped	8	1	9.190 901 1
4 blades	30	1	9.190 903 3



9.190 901

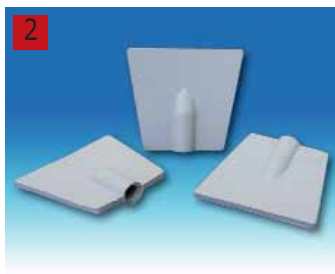

9.190 902



9.190 903



4 LLG-Stoppers, PE, for test tubes

Available in different sizes and colours.

For tubes diam. mm	Colour	PK	Cat. No.
12 - 13	neutral	100	9.231 270
12 - 13	blue	100	9.231 271
12 - 13	yellow	100	9.231 272
12 - 13	red	100	9.231 273
12 - 13	green	100	9.231 274
15 - 16	neutral	100	9.231 275
15 - 16	blue	100	9.231 276
15 - 16	yellow	100	9.231 277
15 - 16	red	100	9.231 278
15 - 16	green	100	9.231 279



5 Rubber stoppers

DIN 12871. Solid.

Bottom diam. mm	Top diam. mm	Height mm	PK	Cat. No.
3.5	6.5	15	1	9.230 203
5.0	9.0	20	1	9.230 205
8.0	12.0	20	1	9.230 208
10.5	14.5	20	1	9.230 210
12.5	16.5	20	1	9.230 212
14.0	18.0	20	1	9.230 214
17.0	22.0	25	1	9.230 217
18.0	24.0	30	1	9.230 218
21.0	27.0	30	1	9.230 221
23.0	29.0	30	1	9.230 223
26.0	32.0	30	1	9.230 226
29.0	35.0	30	1	9.230 229
31.0	38.0	35	1	9.230 231
36.0	44.0	40	1	9.230 236
41.0	49.0	40	1	9.230 241
47.0	55.0	40	1	9.230 247
50.5	59.5	45	1	9.230 250
56.0	65.0	45	1	9.230 256
60.0	70.0	50	1	9.230 260
64.5	75.5	55	1	9.230 264
71.0	83.0	60	1	9.230 271
79.0	92.0	65	1	9.230 279
94.0	107.0	65	1	9.230 294

1 Silicone rubber stoppers

Transparent. To DIN 12871. Solid. Operating temperature up to 220 °C. Supplied singly.

Bottom diam. mm	Top diam. mm	Height mm	PK	Cat. No.
3.5	6.5	15	1	9.230 503
5.0	9.0	20	1	9.230 505
8.0	12.0	20	1	9.230 508
10.5	14.5	20	1	9.230 510
12.5	16.5	20	1	9.230 512
14.0	18.0	20	1	9.230 514
17.0	22.0	25	1	9.230 517
18.0	24.0	30	1	9.230 518
21.0	27.0	30	1	9.230 521
23.0	29.0	30	1	9.230 523
26.0	32.0	30	1	9.230 526
29.0	35.0	30	1	9.230 529
31.0	38.0	35	1	9.230 531
36.0	44.0	40	1	9.230 536
41.0	49.0	40	1	9.230 541
47.0	55.0	40	1	9.230 547
50.5	59.5	45	1	9.230 550
56.0	65.0	45	1	9.230 556



2 Stoppers, rubber, with turn-over flange

These stoppers guarantee perfect sealing even with poorly finished rims on glass or plastic bottles. The top of the stopper has a septum which can be punctured by a hypodermic needle. Very secure fit prevents accidental opening.

Diam. mm	PK	Cat. No.
30.7	1	9.230 657
19.4	1	9.230 655
10.2	1	9.230 651
12.7	1	9.230 652
23.7	1	9.230 656
14.9	1	9.230 653
15.9	1	9.230 654
7.1	1	9.230 650



3 Stoppers, silicone, with turn-over flange

These stoppers guarantee perfect sealing even with poorly finished rims on glass or plastic bottles. The top of the stopper has a septum which can be punctured by a hypodermic needle. Very secure fit prevents accidental opening.

Diam. mm	PK	Cat. No.
30.7	1	9.230 488
19.4	1	9.230 486
10.2	1	9.230 482
12.7	1	9.230 483
23.7	1	9.230 487
14.9	1	9.230 484
15.9	1	9.230 485
7.1	1	9.230 481



4 Stoppers, cork

A1 quality. Non-porous.

Bottom diam. mm	Top diam. mm	Height mm	PK	Cat. No.
3	6	16	1	9.230 703
10	13	22	1	9.230 710
12	15	22	1	9.230 712
14	17	22	1	9.230 714
15	18	22	1	9.230 715
16	19	23	1	9.230 716
18	22	26	1	9.230 718
20	24	27	1	9.230 720
22	26	27	1	9.230 722
26	30	27	1	9.230 726
28	32	27	1	9.230 728
30	34	27	1	9.230 730
45	50	30	1	9.230 745



Vessels/Tube racks

1

1 Microtube Rack, PP, 20-Well

Interlocking racks with 2 x 10 array hold 0.5/1.0/1.5/2.0 ml tubes. Polypropylene racks lock together on each side, permitting the user to attach several together to increase capacity. Features an innovative "hold-it" finger slot on the front, and internal ribbing for stability. Autoclavable. Dimensions: 210 mm x 90 mm x 46 mm.

Colour	PK	Cat. No.
blue	1	9.409 088

2

2 Microtube racks, PP, 80-Well

Autoclavable. Popular fraction collector plate-style rack. Easily load and transfer 80 tubes with 1.5 ml or 2.0 ml in a compact format (5 x 16 array). Polypropylene rack has moulded-in coordinates to aid organisation. Assorted colours. Dimensions (L x W x H): 225 mm x 67 mm x 28 mm.

Colour	PK	Cat. No.
Blue, green, pink, yellow and orange	5	6.237 973
Blue	1	6.243 204
Yellow	1	6.243 205
Natural	1	6.243 206
Orange	1	6.243 207
Pink	1	6.243 208
Green	1	6.243 209

3

3 Microtube racks, PP, 96-Well

Autoclavable. Polypropylene rack has 96 wells for 0.5 ml microcentrifuge tubes on one side and 96 wells for 1.5 ml to 2.0 ml microcentrifuge tubes on the other side. Wells are arranged in standard 8 x 12 array. Handy lid snaps into place via tabs on each end of rack. Dimensions (L x W x H): 246 mm x 121 mm x 50 mm.

Colour	PK	Cat. No.
Blue, green, pink, yellow and orange	5	9.193 982
Natural	1	6.237 620
Blue	1	6.237 267
Green	1	6.237 268
Pink	1	6.237 621
Yellow	1	6.237 622

4

4 Microtube racks, PP, 4-Way

Build as large a rack as you need by linking together multiple rack units. Racks feature a unique system of tabs and slots, which facilitate easy assembly and sturdy fit. Heavy-duty polypropylene racks can hold 4 x 50 ml or 12 x 15 ml conical tubes, 32 x 1.5 ml or 32 x 0.5 ml microtubes. Autoclavable. Dimensions (L x W x H): 175 x 95 x 51 mm.

Colour	PK	Cat. No.
Natural	1	9.409 131
Blue	1	9.409 132
Green	1	9.409 133
Pink	1	9.409 134
Yellow	1	9.409 135
Orange	1	9.409 136
Blue, green, pink, yellow, orange	5	9.409 137

1 Tube Rack for 5ml centrifuge tubes, PP

Designed specifically for 40 x 5 ml centrifuge tubes this rack will also accommodate other tubes with a diameter of 13 to 16 mm. Made of durable and corrosion resistant white polypropylene. End plates have handles for easy transport and stacking

- Steam autoclavable at 121 °C
- Dimensions (L x W x H): 260 x 113 x 105 mm
- Rows: 4 x 10

For tubes diam.	Array	PK	Cat. No.
mm			
13 - 16	40	1	9.194 026



2 Tube Rack Adapt-a-Rack™, POM

Capable of holding different size tubes in each available slot as the well literally adapts to your tube size to hold firmly in an upright position. The design enables you to hold 12 to 30 mm (5 to 50 ml) tubes simultaneously and still allow full viewing of the tube label. Racks can be linked together for additional holding capacity. Autoclavable. Dimensions (W x D x H): 181 x 56 x 76 mm

Colour	Array	PK	Cat. No.
Blue	4	2	9.194 027
Green	4	2	9.194 028
White	4	2	9.194 029



3 Tube Rack, ABS

Made of "modified" high density ABS which enables the rack to be used in water baths. Racks can be linked together to form a multiple rack system. Rod type spacious tube compartments are ideal for screw cap tubes of 15 ml and 50 ml. Unique rack design enables perfect adaptance of the tubes and allows easy viewing of the tube contents. Pegs hold the tubes firmly in place and remain straight even after repeated autoclaving. Interlocking system for linking the racks in multiple rows.

For tubes	Array	PK	Cat. No.
ml			
15	5 x 10	1	6.267 416
50	5 x 5	1	6.267 417



4 Tube Rack pop-up™, foldable, PP

Robust polypropylene construction. Simple, easy to open and close. Flatten for compact storage. Pops up for instant use. Expand and collapse when racks are needed. Printed grid aids rapid retrieval. Stack racks in open or closed position. Saves space when racks are not in use. Not recommended for steam sterilisation. Dimensions (L x W x H): 255 mm x 137 mm x 72 mm when expanded, 21 mm high when collapsed.

For	Colour	PK	Cat. No.
21 x 15 ml and 12 x 50 ml tubes	Pink	2	9.193 997
21 x 15 ml and 12 x 50 ml tubes	Blue	2	9.193 998
45 x 15 ml tubes	Purple	2	6.254 577
18 x 50 ml tubes	Green	2	6.254 578



5 Tube Rack Rota-Rack®, PP

Interlocked racks. Rotate each of the four modules independently. Use several sizes of test tubes, culture tubes, centrifuge tubes or microcentrifuge tubes at the same time. Autoclavable.

Each module of the Rota-Rack® for large tubes holds 2 x 50 ml tubes, 8 x 15 ml tubes, 6 x 20 mm tubes or 10 x 10/13 mm tubes. Each module of the Rota-Rack® for microtubes holds 6 x 15 ml tubes, 9 x 1.5/2.0 ml tubes, 12 x 0.5 ml tubes or 32 x 0.2 ml PCR tubes or 4 x 8-tube strips.

Description	Width mm	Length mm	Height mm	PK	Cat. No.
Rota-Rack® for large tubes	110	224	110	1	9.193 988
Rota-Rack® for micro tubes	100	210	100	1	9.193 989



Vessels/Tube racks



1 Tube rack, PP

Manufactured from high density polypropylene. Due to their weights, they do not float in the water baths, not even in agitated water. These racks are supplied dismantled and can be easily assembled. Autoclavable. A moulded-in alpha-numeric grid reference on the top tier of the rack allows easy sample identification.

Rack dimensions : 250 x 110 x 70 mm

For tubes diam.	Array	PK	Cat. No.
mm			
13	6 x 15	1	9.193 146
16	5 x 12	1	6.238 007
20	4 x 10	1	7.970 029
25	3 x 8	1	9.193 147
30	3 x 7	1	6.237 160



2 Test tube rack, PP, "monoblock"

Manufactured from high density polypropylene. Moulded-in alpha numeric grid reference on the top tier of the rack allows easy sample identification. Due to their weights, they do not float in the water baths. Autoclavable.

Rack dimensions 140 mm x 275 mm x 72 mm

For tubes diam.	Array	PK	Cat. No.
mm			
12 - 13	50	1	9.193 141
15 - 16	50	1	9.193 142
17 - 18	50	1	9.193 143
28 - 30	26	1	9.193 145

LLG-Test tube rack, PP

Made of PP. Stackable. Supplied in three parts and are easy to assemble. Alphanumeric grid referenced on top tier for easy identification of probes. Can be used in water baths. With large lateral marking area. Autoclavable.

For tubes diam.	Colour	Dimensions (l x w x h)	Array	PK	Cat. No.
mm					
16	white	106 x 251 x 71	60	1	6.286 169
16	blue	106 x 251 x 71	60	1	6.286 170 3
16	red	106 x 251 x 71	60	1	6.286 171
20	white	108 x 252 x 72	40	1	6.286 172 4
20	blue	108 x 252 x 72	40	1	6.286 173
20	red	108 x 252 x 72	40	1	6.286 174
30	white	107 x 252 x 71	21	1	6.286 175
30	blue	107 x 252 x 71	21	1	6.286 176
30	red	107 x 252 x 71	21	1	6.286 177 5



6.286 170



6.286 172



6.286 177



6 LLG-Test tube racks, wire/nylon

White nylon-coated wire. Opening size 18 x 18 mm (6.286 416 = 30 x 30 mm)

Length	Width	Height	Array	PK	Cat. No.
mm					
130	54	70	2 x 6	1	6.286 410
248	55	70	2 x 12	1	6.286 411
248	73	70	3 x 12	1	6.286 412
130	95	70	4 x 6	1	6.286 413
248	94	70	4 x 12	1	6.286 414
215	208	70	10 x 10	1	6.286 415
235	85	80	6 x 2	1	6.286 416

1 Test tube racks, stainless steel

Corrosion resistant, stainless steel wire. Electrochemically polished.
Opening size 18 x 18 mm. Mesh grid levels are positioned at the top and 30 mm above the base.

Height	Array	PK	Cat. No.
mm			
70	2 x 12	1	9.193 824
70	3 x 12	1	9.193 836
70	4 x 12	1	9.193 848
100	4 x 12	1	9.193 948



2 LLG-Test tube racks, self-aligning, stainless steel

Robust stainless steel (brushed) test tube racks. Due to the special construction the racks align the test tubes automatically so that the tubes are more comfortable to use. Contamination from vessel to vessel is also reduced as the tops of the tubes do not touch. Dishwasher safe, steam autoclavable, suitable for dry heat (200 °C) and water bath. Each rack holds up to 50 test tubes.

For neck diam.	Bore diam.	Dimensions (l x w x h)	PK	Cat. No.
mm	mm	mm		
16	17.5	224 x 120 x 75	1	9.409 014



3 Test tube holders, wood

Wood with metal spring.

For neck diam.	PK	Cat. No.
mm		
Up to 20	1	9.193 992
Up to 30	1	9.193 993



4 LLG-Sample containers, PP, Heavy Duty, with screw cap, PE-HD

Ideal for liquid specimen collection, transportation and storage.

- Ideally suited for liquid histological samples
- Container made of non-cytotoxic polypropylene
- Very solid quality
- Top and bottom gripping assures easy opening and closing when wearing gloves
- Half-transparency containers
- With graduation
- With label
- Leak proof

Capacity	Diam. with cap	Height	Grad. up to	PK	Cat. No.
ml	mm	mm	ml		
30	37	42	15	1000	6.265 649
60	50	40	30	500	6.265 650
80	50	60	50	500	6.265 651
100	50	77	70	300	6.265 652
140	58	80	120	300	6.265 653
250	97	58	150	154	6.265 654
500	97	112	350	132	6.265 655
1000	120	140	700	64	6.265 656

* without label.



5 LLG-Sample containers, PS/PP, with tamper-evident cap, PE-LD/PP

White with tamper-evident cap. Multi-purpose containers e.g. for storage or transport of samples.

Capacity	Diam. with cap	Height with cap	Material container	Material Lid	PK	Cat. No.
ml	mm	mm				
40	36	52	PS	PE-LD	10	9.402 350
100	58	58	PP	PP	10	9.402 353
250	64	95	PS	PE-LD	10	9.402 356
1000	116	116	PP	PP	5	9.402 359



Vessels/Containers

1



1 LLG-Sample containers, PS, with screw cap, sterile

With PE//PP screw cap. Ideal for many applications as sample collection, transportation or storage.

- Non-cytotoxic
- EO sterilized
- 30 ml container with conical skirted bottom
- Ideal for small volume samples
- Leakproof-tested
- Unique leak tight cap ensures exceptional leak proof seal
- With plain label

Capacity ml	Outer diam. mm	Diam. with cap mm	Height mm	Material container	Material Lid	PK	Cat. No.
7	17	22	48	PS	PP	700	6.265 646
30	24	30	90	PS	PP	50	6.265 647
60	39	43	58	PS	PE	60	6.265 648

2



2 LLG-Sample containers, PP, with screw cap, PP

White with screwed on lid.

Capacity ml	Diam. with cap mm	Height with cap mm	PK	Cat. No.
30	58	19	10	9.402 310
75	58	47	10	9.402 313
310	81	81	10	9.402 318
600	119	67	10	9.402 321
1250	119	130	5	9.402 324

3



3 LLG-Sample containers, PS, with metal cap, sterile

Ideal for sample collection and storage. Made of virgin polystyrene. All materials are non-cytotoxic. The metal cap with inert PVC-Liner ensures leak proof seal.

Capacity ml	Diam. with cap mm	Height with cap mm	PK	Cat. No.
60	43	60	300	9.070 321
60	43	60	60	6.261 958
100	49	75	200	9.070 322
100	49	75	40	6.261 959
250	63	121	50	9.070 323
250	63	121	25	6.261 960

4



4 Rolled rim bottles, Soda-lime glass with PE snap-on lid

With PE snap-on lid. Tight closing.

Capacity ml	Diam. with cap mm	Height with cap mm	PK	Cat. No.
3	19	31	200	9.400 211
5	19	41	200	9.400 215
10	21	51	200	9.400 220
10	22	46	200	9.400 225
15	24	53	200	9.400 235
20	27	56	200	9.400 240
20	25	71	200	9.400 250
25	30	51	250	9.400 230
30	28	76	200	9.400 260
40	30	81	200	9.400 270
50	30	101	200	9.400 280
100	34	146	100	9.400 290

1 Multi-purpose beakers with screw cap, PP

Transparent, with red screw cap. Non-sterile or sterile. Sterile beakers are single packed. Ideal beaker for sampling and storing of solid, muddy and liquid samples.

Description	Capacity ml	Diam. with cap mm	Height with cap mm	PK	Cat. No.
non-sterile	30	43	48	1000	9.401 860
sterile	30	43	48	500	6.287 527
non-sterile*	60	43	67	600	6.260 493
sterile*	60	43	67	500	6.258 714
non-sterile*	120	62	72	500	6.803 183
sterile*	120	62	72	250	6.093 728
sterile	200	64	81	150	6.262 099
non-sterile	200	64	81	200	6.261 429

*with graduation and labelling area

1



2 Multi-purpose beakers, PP

Transparent, pressure-resistant and unbreakable sample cup, ideal for collecting and storing samples of all types. Can be ordered with and without screw cap.

- Graduated
- Writing field on the cup and labeling area on the lid
- Wide opening for easy and safe filling
- Fluid tight sealing screw cap with thread

Description	PK	Cat. No.
Beaker 125 ml, PP, with screw cap, green, HDPE	500	6.238 122
Beaker 125 ml, PP, without screw cap	1000	6.237 981
Screw lid, green, HDPE	1000	6.237 982

2



3 Universal -jars, PE-HD with cap, PE-LD

PE-HD with PE-LD cap. Resistant to acids and chemicals. Suitable for cold storage rooms, refrigerators and freezers. Stackable. Food safe. Color: natural.

Capacity ml	Diam. with cap mm	Height with cap mm	PK	Cat. No.
200	98	42	1	9.033 201
400	114	55	1	9.033 202
700	114	88	1	9.033 211
1000	136	110	1	9.033 212
2000	169	143	1	9.033 213

3



4 Cylindrical jars with ribbed cap, PE-HD

The cylindrical jars are supplied with insert and cap. Thanks to the large neck they are suitable for powders, solid specimen, creamy or semisolid substances, crystals and hygroscopic substances. Suitable for foodstuff according to EC Regulation 1935/2004 and EC Regulation 10/2011.

Capacity ml	Diam. with cap mm	Neck i. d. mm	Height with cap mm	PK	Cat. No.
70	50	36	60	1	6.205 920
120	56	36	71	1	6.206 304
250	69	50	94	1	6.205 857
500	86	70	107	1	6.205 921
1000	111	85	128	1	6.205 922
1500	111	87	182	1	6.226 130
2000	111	87	235	1	6.223 901

4



Vessels/Wide-neck jars - Transport boxes



1 LLG-Wide-neck jars, glass

Twist-off jar, wide-neck. Perfect for sample storage. Glass, clear.
Without cap, please order cap separately.

Capacity ml	Ø Glass jar mm	Height Glass jar mm	PK	Cat. No.
106	48	78.0	12	9.070 301
212	63	80.5	12	9.070 302
375	63	120.5	12	9.070 303
720	82	148.0	12	9.070 304
1062	82	176.0	12	9.070 305



2 Caps for LLG-Wide-neck jars

Twist-off screw cap for LLG-Wide-neck jars

For	Diam. mm	PK	Cat. No.
106 ml LLG Twist-Off-jar	48	12	9.070 306
212 ml and 375 ml LLG Twist-Off-jar	63	12	9.070 307
720 ml and 1062 ml LLG Twist-Off-jar	82	12	9.070 308



3 LLG-Bottle carriers, wire/nylon

For carrying laboratory bottles.

For bottles ml	Int. diam. mm	PK	Cat. No.
6 x 2000	130	1	6.286 408
6 x 1000	100	1	6.286 409



4 Display boxes, PS

Polystyrol. Heavy duty, industrial quality. Stackable (lengthways and crosswise). With RAL certificate.
Shock-resistant, high impact PS. Food safe colors. Smooth underbody, therefore suitable for transport.

Colour	Width mm	Depth mm	Height mm	Size	PK	Cat. No.
red	100	165	75	2	1	9.033 121
blue	100	165	75	2	1	9.033 123
green	100	165	75	2	1	9.033 124
red	145	232	125	3	1	9.033 131
blue	145	232	125	3	1	9.033 133
green	145	232	125	3	1	9.033 134
red	200	336	150	4	1	9.033 141
blue	200	336	150	4	1	9.033 143
green	200	336	150	4	1	9.033 144



5 Storage and transport containers, PP/PE-HD

White. Made of thermoplastic resin. Stackable.

The raw material used is physiologically compatible and corresponds with the directives of the Federal Board of Health.

Capacity Litres	External dimensions (W x D x H) mm	Internal dimensions (W x D x H) mm	Material	PK	Cat. No.
9	560 x 360 x 64	510 x 310 x 60	PP	1	9.301 643
10	445 x 345 x 90	410 x 310 x 85	PP	1	9.301 641
23	460 x 330 x 210	395 x 295 x 200	HDPE	1	9.301 663
28	660 x 450 x 130	600 x 400 x 120	HDPE	1	9.301 647
31	550 x 450 x 170	480 x 410 x 160	HDPE	1	9.301 645
35	600 x 350 x 220	530 x 315 x 210	HDPE	1	9.301 661
50	660 x 450 x 220	600 x 400 x 210	HDPE	1	9.301 649
96	660 x 450 x 410	600 x 400 x 400	PP	1	9.301 651



6 Lids for stacking and transport containers.

For	Width mm	Length mm	PK	Cat. No.
9.301 647 / 649 / 651	450	660	1	9.301 655
9.301 663	330	460	1	9.301 664

1 Collapsible Box mini, PP, stackable

A straightforward and tough folding mechanism permits a safe and easy handling. Volume 4 liter, weight 180 g, load 2.5k g. Dishwasher safe, food safe. Autoclavable at 120 °C, enduring temperature stability from -40 °C to 90 °C.

Colour	Width mm	Depth mm	Height mm	PK	Cat. No.
black	238	161	100	1	9.301 480
white	238	161	100	1	9.301 481



2 Collapsible Box midi, PP, stackable

A straightforward and tough folding mechanism permits a safe and easy handling. Volume 14.5 liter, weight 300 g, load 8 kg. Dishwasher safe, food safe. Autoclavable at 120 °C, enduring temperature stability from -40 °C to 90 °C. The Folding Box mini perfectly fits two-times into the Midi.

Colour	Width mm	Depth mm	Height mm	PK	Cat. No.
black	400	300	145	1	9.301 485
white	400	300	145	1	9.301 486
blackberry	400	300	145	1	9.301 489



3 Euronormboxes, PP, stackable

Solid transparent plastic containers, odorless, cold and heat-resistant, stable against most acids and alkalis. Dishwasher safe, food safe. Two sizes (40 x 30 cm and 60 x 40 cm) available.

- Corresponding lids please order separately
 - Suitable Trolley (Cat. No.: 9.301 502)

Type	Capacity l	External dimensions (W x D x H) mm	Colour	PK	Cat. No.
Euronormbox	20	400 x 300 x 220	transparent	1	9.301 503
Lid	-	400 x 300 x 10	transparent	1	9.301 506
Euronormbox	46	600 x 400 x 220	transparent	1	9.301 504
Euronormbox	66	600 x 400 x 320	transparent	1	9.301 505
Lid	-	600 x 400 x 10	transparent	1	9.301 507



4 Storage boxes, PE-HD with tightly closing PE-LD lid

PE-HD. With tightly closing PE-LD lid. Suitable for cold storage rooms and refrigerators. Temperature range/withstands temperatures (without mechanical stress) from -20 to +95°C. Stackable. Acid and chemical resistant. Food safe. Colour: natural.

Capacity L	Width mm	Depth mm	Height mm	PK	Cat. No.
0.50	103	103	64	1	9.033 270
1.00	103	103	127	1	9.033 275
1.00	103	208	64	1	9.033 280
1.50	103	208	94	1	9.033 285
2.00	103	255	94	1	9.033 286
2.00	208	208	64	1	9.033 287
3.20	208	208	94	1	9.033 288



5 LLG-Buckets, PP

White. With lid and temper-evident closure. For transport, packaging and storage of foodstuffs, building materials and non-corrosive chemicals. Stability guaranteed when filling up with material up to 80 °C.

Capacity Litres	Diam. mm	Height mm	PK	Cat. No.
1	131	127	1	9.040 030
2	179	133	1	9.040 031
3	198	141	1	9.040 032
5	224	193	1	9.040 033
10	266	265	1	9.040 034



6 LLG-Buckets, PP

White. Round. With metal handle. Graduated.

Capacity Litres	PK	Cat. No.
10	1	9.040 216





1 LLG-Bottles, wide mouth, PE-HD

Suitable for food. With carrying handle. Ideal for containing liquids, powders and granules. Very strong and durable quality for extended use over time. With screw cap and additional inner cap for a very tight seal. Screw cap can be attached to the bottle using the integrated loops. The bottles can be used by temperature from -40 °C to +80 °C. Please use only in upright position.

Capacity	Neck Int. diam.	Neck Ext. diam.	Body diam.	Height	Handle	PK	Cat. No.
Litres	mm	mm	mm	mm			
5	84	94	170	350	1	1	9.139 938
10	99	109	210	420	1	1	9.139 939



2 LLG-Aspirator Bottles, narrow neck, PE-HD

With carrying handle. Suitable for food. Very strong and durable quality for extended use over time. With gasket in the screw cap for a very tight seal. Screw cap can be attached to the bottle using the integrated loops. With thread of 12 mm depth for use with a 3/4" stopcock. Please order the stopcock separately (Cat. No. 9.139 937). The bottles can be used by temperatures from -40 °C to +80 °C.

Please use only in upright position.

Capacity	Neck Int. diam.	Neck Ext. diam.	Body diam.	Height	Handle	PK	Cat. No.
Litres	mm	mm	mm	mm			
5	52	62	160	350	1	1	9.139 929
10	52	62	210	430	1	1	9.139 930
25	84	97	270	570	2	1	9.139 931
50	84	97	350	690	2	1	9.139 932



3 LLG-Aspirator Bottles, narrow neck, PE-HD, with stopcock

With carrying handle and 3/4" stopcock. Thread and opening for stopcock provided. Suitable for food. Very strong and durable quality for extended use over time. With gasket in the screw cap for a very tight seal. Screw cap can be attached to the bottle using the integrated loops. The bottles can be used by temperature from -40 °C to +80 °C.

Please use only in upright position.

Capacity	Neck Int. diam.	Neck Ext. diam.	Body diam.	Height	Handle	PK	Cat. No.
l	mm	mm	mm	mm			
5	52	62	160	350	1	1	9.139 933
10	52	62	210	430	1	1	9.139 934
25	84	97	270	570	2	1	9.139 935
50	84	97	350	690	2	1	9.139 936



4 Stopcock, 3/4", for LLG-Aspirator bottles

For 9.139 929 - 9.139 932 and 9.139 933 - 9.139 936.

Type	PK	Cat. No.
Tap for aspirator bottles	1	9.139 937

1 Industrial jerrycans, PE-HD

Jerrycans with capacity of 2 to 30 L.
Please order closures separately.

Capacity	Colour	Width	Depth	Height	Weight	Thread external diam.	PK	Cat. No.
L		mm	mm	mm	g	mm		
2.00	natural	145	109	196	110	45	1	9.140 021
2.50	natural	153	115	208	125	45*	1	9.140 022
3.00	natural	153	115	240	140	45*	1	9.140 023
5.00	natural	190	145	251	250	50*	1	9.140 025
6.00	natural	192	145	294	265	45	1	9.140 026
10.00	natural	230	190	310	450	50*	1	9.140 030
20.00	blue	290	246	385	950	60*	1	9.140 032
25.00	blue	290	246	450	1100	60*	1	9.140 031
30.00	blue	320	284	435	1250	60*	1	9.140 033
20.00	natural	290	246	385	950	60*	1	9.140 037
30.00	natural	320	284	435	1250	60*	1	9.140 038

* With UN approval.



2 Screw caps and accessories for industrial jerrycans, PE-HD



For	Description	PK	Cat. No.
5 / 10 litre jerrycans	Black, with tear-off ring and vent	1	9.140 068
2 / 2.5 / 3 / 6 / 8 litre jerrycans	Black, with tear-off ring and vent	1	9.140 048
20 / 25 / 30 litre jerrycans	Black, with tear-off ring and vent	1	9.140 050
2 / 2.5 / 3 / 6 / 8 litre jerrycans	Black, with tear-off ring	1	9.140 051
20 / 25 / 30 litre jerrycans	Black, with tear-off ring	1	9.140 047
5 / 10 litre jerrycans	Black, with tear-off ring	1	9.140 046
2 / 2.5 / 3 / 6 / 8 litre jerrycans	Red, with tear-off ring	1	9.140 040
5 / 10 litre jerrycans	Red, with tear-off ring	1	9.140 042
20 / 25 / 30 litre jerrycans	Red, with tear-off ring	1	9.140 043
2 / 2.5 / 3 / 6 / 8 litre jerrycans	With stopcock	1	9.140 062
5 / 10 litre jerrycans	With stopcock	1	9.140 061
20 / 25 / 30 litre jerrycans	With stopcock	1	9.140 063
10 litre jerrycans	With pump dispenser	1	9.140 065
2 / 2.5 / 3 / 6 / 8 litre jerrycans	Wrench, PE-HD to apply / remove	1	9.140 073
5 / 10 / 20 / 25 / 30 litre jerrycans	Wrench, PE-HD to apply / remove	1	9.140 108

Vessels/Wide-mouth bottles



1 Laboratory bottles Borosilicate glass 3.3, GL 45, with retrace code

Borosilicate glass 3.3. DIN 168 - 1. EN ISO 4796-1.
With graduations and retrace code, pouring ring, PP screw cap with ISO thread.
Certificates are available on request.

Capacity	Ext. diam.	Height	PK	Cat. No.
ml	mm	mm		
100	56	100	10	9.072 331
250	70	138	10	9.072 332
500	86	176	10	9.072 334
1000	101	225	10	9.072 335
2000	136	260	10	9.072 336
5000	186	330	1	9.072 337
10000	234	410	1	9.072 338



2 Wide-mouth bottles, soda-lime glass

Clear or amber glass. Round thread neck in accordance with DIN 168.
Please order screw caps separately.

Colour	Capacity	Diam.	Height	Neck thread	PK	Cat. No.
	ml	mm	mm	GL		
clear	30	36.0	68.0	32	120	6.287 779
clear	50	44.0	75.0	32	85	7.960 501
clear	100	50.0	93.0	40	63	7.960 502
clear	125	54.0	98.0	40	80	7.960 503
clear	150	57.0	104.0	45	42	9.072 210
clear	250	70.0	113.0	55	48	7.960 504
clear	500	84.0	154.0	55	20	7.960 505
clear	1000	103.5	180.5	68	18	7.960 506
amber	30	36.0	68.0	32	126	7.960 507
amber	50	44.0	75.0	32	85	7.960 508
amber	100	50.0	92.5	40	56	6.270 392
amber	125	54.0	98.0	40	84	7.960 510
amber	150	57.0	104.0	45	48	9.072 211
amber	250	70.0	113.0	55	30	6.287 780
amber	500	84.0	154.0	55	20	7.960 512
amber	1000	103.5	180.5	68	12	7.960 513



3 Screw caps for wide-mouth bottles, PP/LDPE

Cap PP, seal LDPE

Neck thread	Material	PK	Cat. No.
GL			
32	PP	1	9.072 164
40	PP	1	9.072 165
55	PP	1	9.072 166
68	PP	1	9.072 167
45	PPN	1	6.272 535



1 LLG-Wide-mouth bottles, with screw cap, PE-LD, economy pack

Natural, translucent. Thick-walled. Ideal for taking, storing and transporting samples of liquids, pastes and granulated products. Ideal for liquids, pastes and granulates.

Complete with lid. Replacement lids, please see Cat. No. 9.072 778 to 9.072 782.

Capacity	Diam.	Thread external diam.	Height	PK	Cat. No.
ml	mm	mm	mm		
50	39.0	32	76.0	50	9.073 510
100	48.0	32	93.5	20	9.073 511
250	64.0	40	120.0	10	9.073 512
500	77.0	50	154.0	10	9.073 513
1000	95.0	65	205.0	4	9.073 514
1500	108.0	65	226.0	4	9.073 515
2000	120.0	65	247.0	1	9.073 516



2 Wide-mouth bottles, PE, graduated

Will withstand considerable pressure before rupturing. Secured by tagging points on bottle and PP cap.

Confidential notes can be placed in the space between insert sealing plug and cap.

Suitable for foodstuff according to EC Regulation 1935/2004 and EC Regulation 10/2011.

Capacity	Grad.	Ext. diam.	Int. diam.	Height	PK	Cat. No.
ml	ml	mm	mm	mm		
50	10	40	24.00	77	1	9.072 950
100	20	48	24.00	89	1	9.072 951
250	25	61	34.50	126	1	9.072 952
500	50	75	34.50	158	1	9.072 953
1000	100	93	45.00	200	1	9.072 954
2000	100	115	45.00	247	1	9.072 955



3 Wide-mouth bottles, PE, square, graduated, with screw cap

Space saving bottles, ideal for long term storage of samples. With PP screw cap. Approximate graduations allow reproducible filling without the use of cylinders/beakers. Easy grip caps can be wired down for security.

Suitable for foodstuff according to EC Regulation 1935/2004 and EC Regulation 10/2011.

Capacity	Grad.	Tubing i.d.	Width	Depth	Height	PK	Cat. No.
ml	ml	mm	mm	mm	mm		
25	5	18.0	32	34	52	1	9.072 943
50	10	24.0	38	38	70	1	9.072 944
100	20	34.5	42	48	90	1	9.072 945
250	50	34.5	57	60	110	1	9.072 946
500	100	45.0	70	80	138	1	9.072 947
1000	100	58.0	80	103	176	1	9.072 948
2000	100	58.0	100	134	210	1	9.072 949





1 Narrow-mouth Winchester bottles, soda-lime glass

Amber, with PP (Pilferproof) 28 neck finish.

Please order caps separately.

Capacity ml	Colour	Diam. mm	Height mm	PK	Cat. No.
50	amber	40.5	81.0	99	9.070 201
100	amber	50.5	96.0	56	9.070 202
250	amber	65.0	133.0	39	9.070 203
500	amber	82.0	160.0	20	9.070 205
1000	amber	100.5	207.0	14	9.070 204



2 Screw caps for narrow-mouth bottles, PP 28

PP Cap (Pilferproof) 28 neck finish, with approx. 19.4 mm inner mouth.

Description	PK	Cat. No.
Screw caps, black, with foam insert	500	6.272 536
Screw caps, white with cone sealing	500	6.272 537



3 LLG-Mini Narrow-neck vials, PP, Heavy Duty

Ideal for collecting, transporting and storing liquid samples.

- With screw cap
- Very stable design
- Transparent
- With graduation

Capacity ml	Diam. mm	Thread external diam. mm	Height mm	PK	Cat. No.
4	16.0	13	40	100	6.289 520
8	25.0	19	44	100	6.289 450
30	36.0	19	61	100	6.289 451
60	40.0	19	85	100	6.289 452
125	51.0	23	99	50	6.289 453



4 LLG-Narrow-mouth bottles with cap, PE-LD, economy pack

Transparent with cap.

Capacity ml	Diam. mm	Thread external diam. mm	Height mm	PK	Cat. No.
50	37.0	18	78.0	50	9.073 500
100	47.0	18	105.0	20	9.073 501
250	63.0	25	119.0	10	9.073 502
500	78.0	25	152.0	10	9.073 503
1000	96.0	28	206.0	4	9.073 504
2000	120.0	28	264.0	1	9.073 505



5 LLG-Wash bottles, narrow neck, PE

Easy to squeeze, semi-rigid, translucent, with excellent clarity. The stream of the liquid can be easily controlled by hand pressure. Dispensing tip provides extra fine stream - tip can be cut back in order to increase the flow rate, if required.

Capacity ml	PK	Cat. No.
100	1	9.223 500
250	1	9.223 501
500	1	9.223 502
1000	1	9.223 503

1 LLG-Safety wash bottles, PE-LD

Manufactured from PE-LD and with the safety label printed on the wash bottle in accordance with regulation (EC) No. 1272/2008 (GHS).

- Colour coded cap and bottle for easy and quick recognition of the bottle content
- Dispensing tube designed to optimize backflow and turbulence-free operation.
- Permanent printing on the body of safety symbols in acc. with GHS, as well as of chemical formula, CAS number, hazard pictogram, signal word, hazard statements and NFPA code.
- Chemical name and Warning texts in German, English, French and Spanish

Colour	Capacity ml	Print	PK	Cat. No.
red	500	acetone	1	9.223 504
blue	500	distilled water	1	9.223 505
green	500	ethanol	1	9.223 506
yellow	500	isopropanol	1	9.223 507
orange	500	methanol	1	9.223 508

1



2 LLG-Safety vented wash bottles, PE-LD

- Wide mouth wide neck wash bottles featuring the patented DripLok® vapour venting valve that prevents solvent drips
- Indelibly printed
- Choose from 4 solvent labels all including the new Globally Harmonised Symbols, NFPA diamond, risk phrases and safety information
- Fitted with colour coded, one-piece polypropylene closures that maintain their shape in use
- Closures feature precision jet-tip aperture for fine control

Print	Language	Colour	Capacity ml	PK	Cat. No.
Acetone	SP/FR/D/UK	red	500	1	9.223 491
Acetone	N/DK/S/UK	red	500	1	4.661 903
Acetone	RU/PL/D/UK	red	500	1	4.661 904
Acetone	ARAB/FR/UK	red	500	1	4.661 905
Methanol	SP/FR/D/UK	orange	500	1	9.223 492
Methanol	N/DK/S/UK	orange	500	1	4.661 906
Methanol	RU/PL/D/UK	orange	500	1	4.661 907
Methanol	ARAB/FR/UK	orange	500	1	4.661 908
Isopropanol	SP/FR/D/UK	yellow	500	1	9.223 493
Isopropanol	N/DK/S/UK	yellow	500	1	4.661 909
Isopropanol	RU/PL/D/UK	yellow	500	1	4.661 910
Isopropanol	ARAB/FR/UK	yellow	500	1	4.661 911
Ethanol	SP/FR/D/UK	green	500	1	9.223 494
Ethanol	N/DK/S/UK	green	500	1	4.661 912
Ethanol	RU/PL/D/UK	green	500	1	4.661 913
Ethanol	ARAB/FR/UK	green	500	1	4.661 914

2



3 Dropper bottles, PE-HD

Natural. Highly suitable for adhesives and other liquids that can be finely dispensed.

PE-HD combination closure with screw-on dropping tip (Cat. No. 9.073 313). Please order separately.

Capacity ml	Diam. mm	PK	Cat. No.
10	24.0	1	9.073 310
25	31.3	1	9.073 311
50	40.0	1	9.073 312

3



4 Cap for dropping bottles, PE-HD

For bottles 9.073 310 to 9.073 312 series.

Type	PK	Cat. No.
Cap for dropping bottles	1	9.073 313

4



Vessels/Funnels



1 LLG-Funnel, borosilicate glass 3.3

With short stem. Cone angle of 60°. Standard borosilicate funnels with excellent heat resistance. All funnels have a cone angle of 60° and therefore offer an optimum fit for all filter sizes. Autoclavable.

Funnel diam. mm	Shaft diam. mm	For filter paper diam. mm	Overall length mm	PK	Cat. No.
40	6.0	55 - 70	70	1	9.251 200
60	8.0	70 - 90	100	1	9.251 201
80	8.0	125 - 150	140	1	9.251 202
100*	10.0	150 - 185	180	1	9.251 203
125*	16.0	185 - 240	210	1	9.251 204
150*	16.0	240 - 270	250	1	9.251 205

* according to DIN ISO 4798



2 LLG-Fast filtration funnels with internal ribs, PP

Clear, virgin polypropylene, autoclavable at 121 °C and 1.1 bar for 30 minutes. The external ribs prevent airlock and back pressure. The internal helicoidal rib prevents filter papers from sticking and increases filtration speed.

Funnel diam. mm	Shaft diam. mm	For filter paper diam. mm	Stem length mm	PK	Cat. No.
40	6.0	55 - 70	40	10	9.251 191
60	8.0	70 - 90	60	10	9.251 192
80	8.0	125 - 150	80	10	9.251 193
80	9.0	125 - 150	150	10	9.251 197
100	10.0	150 - 185	100	10	9.251 194
120	16.0	185 - 240	120	10	9.251 195



3 LLG-Funnels, PP

Made of clear, virgin polypropylene, autoclavable at 121 °C and 1.1 bar for 30 minutes.

Funnel diam. mm	Shaft diam. mm	For filter paper diam. mm	Stem length mm	PK	Cat. No.
40	6.0	55 - 70	40	10	9.251 185
60	8.0	70 - 90	60	10	9.251 186
80	8.0	125 - 150	80	10	9.251 187
100	10.0	150 - 185	100	10	9.251 188
120	16.0	185 - 240	120	10	9.251 189
150	16.0	240 - 270	150	10	9.251 190



4 Powder funnels, PP

Transparent. With short, wide stem. For transfer of powdered and granular substances. Rapid flow due to a steep 60° angle. Food-safe products according to EC Directive No. 10/2011.

Funnel diam. mm	Stem diam. mm	Height mm	PK	Cat. No.
65	15	68	1	9.251 720
80	21	76	1	9.251 725
100	22	94	1	9.251 730
120	26	110	1	9.251 735
150	28	138	1	9.251 740
180	43	160	1	9.251 741



5 Powder funnels with NS-cone, borosilicate glass 3.3

With short stem and NS cone.

Funnel diam. mm	Stem diam. mm	NS	PK	Cat. No.
60	13	14/23	1	4.008 433
80	17	19/26	1	4.008 434
100	22	24/29	1	4.008 435
120	26	29/32	1	4.008 436

1 Powder funnels with NS-cone, PP

Transparent. For multi-neck flasks, laterally flattened, suitable for standard joint necks of various sizes. Suitable for the filling of liquid or powdered reagents into a reaction flask, particularly multi-neck flasks, during a reaction. Food-safe product according to EC Directive No. 10/2011.

Funnel diam. mm	Height mm	Joint size (NS)	PK	Cat. No.
40	75	14 / 23	1	9.251 814
50	95	19 / 26	1	9.251 819
75	135	29 / 32	1	9.251 829



2 LLG-Funnel holder, stainless steel, with or without boss head

These funnel holders are suitable to hold all types of funnels with a diameter up to 150 mm. They can also accommodate separating funnels (up to 1000 ml). With or without boss head.

Description	Diam. mm	PK	Cat. No.
without bosshead	40	1	9.251 550
without bosshead	60	1	9.251 551
without bosshead	80	1	9.251 552
without bosshead	100	1	9.251 553
with bosshead	40	1	9.251 554
with bosshead	60	1	9.251 555
with bosshead	80	1	9.251 556
with bosshead	100	1	9.251 557



3 Funnel holder, chromated steel

Adjustable height 140 to 220 mm. Inner diameter upper ring: 46 mm. Outer diameter bottom ring: 126 mm.

Description	PK	Cat. No.
Funnel holder	1	4.008 510



4 Watch glasses, Soda-lime glass

To DIN 12341. Ground edges. Hydrolytical class 3.

Diam. mm	PK	Cat. No.
40	1	9.263 004
50	1	9.263 005
60	1	9.263 006
70	1	9.263 007
80	1	9.263 008
90	1	9.263 009
100	1	9.263 010
110	1	9.263 011
120	1	9.263 013
125	1	9.263 012
150	1	9.263 015
200	1	9.263 020
250	1	9.263 025



5 Watch glasses, PP

With base. Resistant to steam sterilisation (121 °C). Autoclavable.

Diam. mm	PK	Cat. No.
60	1	9.263 526
80	1	9.263 528
100	1	9.263 530
125	1	9.263 532



Vessels/Dishes



1 2 LLG-Crystallising dishes, borosilicate glass

Crystallising dishes with or without spout. DIN 12337/12338. Autoclavable.

Description	Capacity ml	Diam. mm	Height mm	DIN	PK	Cat. No.
without spout	20	40	25	12337	1	7.616 800
without spout	40	50	30	12337	1	6.228 031
without spout	60	60	35	12337	1	6.236 596
without spout	100	70	40	12337	1	6.233 757
without spout	150	80	45	12337	1	6.227 688
without spout	300	95	55	12337	1	6.205 104
without spout	500	115	65	12337	1	6.205 105
without spout	900	140	75	12337	1	6.236 597
without spout	2000	190	90	12337	1	6.236 598
without spout	3500	230	100	12337	1	6.236 599
with spout	20	40	25	12338	1	6.226 043
with spout	40	50	30	12338	1	7.616 171
with spout	60	60	35	12338	1	6.227 922
with spout	100	70	40	12338	1	6.228 387
with spout	150	80	45	12338	1	6.225 256
with spout	300	95	55	12338	1	6.803 567
with spout	500	115	65	12338	1	6.223 298
with spout	900	140	75	12338	1	6.206 856
with spout	2000	190	90	12338	1	6.803 371
with spout	3500	230	100	12338	1	6.231 072



3 LLG-Porcelain evaporating dishes with spout, flat bottom, shallow form

Glazed.

Capacity ml	Ext. diam. mm	Height mm	DIN	PK	Cat. No.
20	60	14	12903	1	9.115 302
55	80	20	12903	1	9.115 303
110	100	25	12903	1	6.231 540
250	130	30	12903	1	9.115 304
450	160	40		1	9.115 306



4 LLG-Porcelain evaporating dishes with spout, round bottom, medium form

Glazed.

Capacity ml	Ext. diam. mm	Height mm	DIN	PK	Cat. No.
20	50	20	12903	1	9.115 311
30	63	25	12903	1	6.239 177
60	80	32	12903	1	9.115 312
110	96	30		1	9.000 152
150	100	40	12903	1	9.115 313
240	127	42		1	9.000 153
285	125	50	12903	1	9.115 314
420	154	50		1	6.232 525
700	170	74	12903	1	9.115 315



5 LLG-Porcelain evaporating dishes with spout, flat bottom, medium form

Glazed.

Capacity ml	Ext. diam. mm	Height mm	PK	Cat. No.
93	86	33	1	6.251 474

1 Instrument trays, melamine resin

White, melamine resin. Autoclavable (121 °C)

Width mm	Depth mm	Height mm	PK	Cat. No.
190	150	20	1	7.608 352
240	180	20	1	9.200 324
270	210	20	1	9.200 327
300	150	20	1	9.200 328
300	190	20	1	7.055 383
360	240	20	1	9.200 335
430	290	20	1	9.200 345

7.603 295 with handle bar



2 Instrument boxes, melamine resin

Melamine resin. Base section is autoclavable (121 °C).

Please order lid separately.

Width mm	Depth mm	Height mm	PK	Cat. No.
110	210	30	1	9.200 177
150	190	40	1	9.200 170
160	290	30	1	9.200 165
160	290	60	1	9.200 160
240	350	40	1	9.200 155
250	350	100	1	9.200 150



3 Lids, PS for instrument boxes

For	PK	Cat. No.
9.200 177	1	9.200 181
9.200 170	1	9.200 182
9.200 165 and 9.200 160	1	9.200 183
9.200 155 and 9.200 150	1	9.200 184

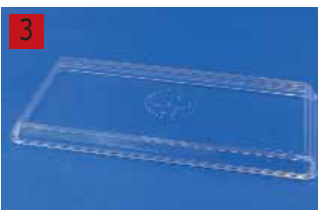

4 LLG-Assortment box, PS

Designed for storing and transporting small labwares such as magnetic stirring bars. Manufactured from clear material for easy observation of the contents. Different size of compartments for different size of materials.

Width mm	Depth mm	Height mm	PK	Cat. No.
97	182	33	1	6.267 405



5 Trays, stainless steel

Remanit® 4301. With edge rim.

Width mm	Depth mm	Height mm	PK	Cat. No.
110	170	20	1	9.150 722
120	200	20	1	9.150 723
140	220	28	1	9.150 724
180	240	30	1	9.150 726
210	310	40	1	9.150 729
250	350	40	1	9.150 730
280	420	50	1	9.150 732
340	520	50	1	9.150 733



6 Tray, PP

For multi purpose use. Durable and resist to bending, with strong rounded rim. Stackable for space solving solutions, polished surface for easy cleaning. Resistant to many acids and alkaline solutions, can be used with foods.

Width mm	Depth mm	Height mm	PK	Cat. No.
127	183	50	1	6.267 362
180	255	60	1	6.267 363
245	355	70	1	6.267 364



Vessels/Crucibles

1

1 LLG-Porcelain crucibles, low, DIN 12904

To DIN 12904. Glazed.

Form	Capacity ml	Ext. diam. mm	Height mm	PK	Cat. No.
Low form	5	30	19	1	9.250 900
Low form	10	35	22	1	9.250 901
Low form	17	40	25	1	9.250 902
Low form	21	45	28	1	9.250 903
Low form	34	50	32	1	9.250 904
Low form	63	60	38	1	9.250 905
Low form	91	70	44	1	9.250 906

2

2 LLG-Porcelain crucibles, medium, DIN 12904

To DIN 12904. Glazed.

Form	Capacity ml	Ext. diam. mm	Height mm	PK	Cat. No.
Medium	10*	30	25	1	9.250 907
Medium	12	35	28	1	9.250 910
Medium	20	40	32	1	9.250 911
Medium	30	45	36	1	9.250 912
Medium	45	50	40	1	9.250 913
Medium	80	60	48	1	9.250 914
Medium	120	70	56	1	9.250 915
Medium	200*	80	62	1	9.250 916

* Not to DIN

3

3 LLG-Porcelain crucibles, tall, DIN 12904

To DIN 12904. Glazed.

Form	Capacity ml	Ext. diam. mm	Height mm	PK	Cat. No.
Tall form	15	30	38	1	9.250 920
Tall form	26	35	44	1	9.250 921
Tall form	35	40	50	1	9.250 922
Tall form	50	45	56	1	9.250 923
Tall form	72	50	62	1	9.250 924
Tall form	130	60	75	1	9.250 925

4

4 Porcelain lids for LLG-Crucibles, DIN 12904

Glazed.

Lid diam. mm	Crucible diam. mm	DIN	PK	Cat. No.
34	30	12904	1	9.250 930
39	35	12904	1	9.250 931
44	40	12904	1	9.250 932
49	45	12904	1	9.250 933
54	50	12904	1	9.250 934
64	60	12904	1	9.250 935
74	70	12904	1	9.250 936
84	80	12904	1	9.250 937

5

5 Crucibles, quartz glass, medium form

Transparent silica (Quartz glass). Medium form.

Capacity ml	Ext. diam. mm	Height mm	PK	Cat. No.
20	40	32	1	9.250 340
49	50	40	1	9.250 350
90	60	48	1	9.250 351

Filter crucibles please see page 116.

1 LLG-Porcelain incinerating dishes

Form	Capacity ml	Ext. diam. mm	Height mm	Spout	PK	Cat. No.
deep	21	40	20	without	1	6.237 126
deep	64	60	30	with	1	6.241 972
deep	64	60	30	without	1	6.242 424
low	70	81	20	without	1	7.654 046
deep	103	70	35	without	1	7.654 045



2 LLG-Porcelain incinerating boats, with loop handle

Unglazed.

Width mm	Depth mm	Height mm	PK	Cat. No.
13	85	8	1	9.250 942
13	90	8	1	6.243 229
14	105	9	1	9.250 941



3 Magnesia trays

Width mm	Depth mm	PK	Cat. No.
9	100	100	9.152 109



4 Magnesia rods

For flame tests.

Type	PK	Cat. No.
Magnesia rods	100	9.152 125



Tools/Spoons, Spatulas

1

1 Pharmacist's spoon, stainless steel

Remanit® 4301. Polished. Slim form. Length 150 mm.

Dimensions Spoon (L x W) mm	Length mm	PK	Cat. No.
30 x 16	150	1	9.150 060

2

2 Reagent spoons, 18/10 steel

Dimensions Spoon (L x W) mm	Overall length mm	PK	Cat. No.
25 x 15	200	1	4.008 513

3

3 LLG-Multi-purpose spoon, 18/10 steel

For	Dimensions Spoon (L x W) mm	Dimensions Spatulas (L x W) mm	Overall length mm	PK	Cat. No.
Right hander	35 x 15	25 x 13	150	1	9.150 800
Right hander	35 x 15	25 x 13	180	1	9.150 801
Right hander	35 x 15	25 x 13	210	1	9.150 802
Right hander	35 x 15	25 x 13	250	1	9.150 073
Right hander	35 x 15	25 x 13	300	1	9.150 074
Left hander	35 x 15	25 x 13	180	1	9.150 081
Left hander	35 x 15	25 x 13	210	1	9.150 082

4

4 Spatulas, round grooved, 18/10 steel

Polished, round grooved.

Length mm	Spatula width mm	PK	Cat. No.
150	9	1	4.008 448
180	9	1	4.008 449
210	9	1	4.008 450

5

5 LLG-Spoon spatulas, 18/10 steel, wide form

18/10 steel. Wide form.

Dimensions Spoon (L x W) mm	Dimensions Spatulas (L x W) mm	Length mm	PK	Cat. No.
31 x 23	30 x 20	120	1	4.008 445
38 x 27	32 x 22	150	1	9.150 810
40 x 30	35 x 25	180	1	9.150 811
40 x 30	35 x 25	210	1	9.150 812
50 x 38	45 x 32	250	1	4.008 446
55 x 45	50 x 40	300	1	4.008 447

1 Micro spoon spatulas, 18/10 steel

Excellent grade polished stainless steel with one end having a flat spatula and the other end having a micro spoon.

Dimensions Spoon (L x W) mm	Length mm	PK	Cat. No.
9 x 5	150	1	9.150 820
9 x 5	180	1	4.008 451



2 Double ended spatulas, 18/10 steel

18/10 steel. Narrow form.

Type	Length mm	PK	Cat. No.
straight	130	1	4.008 454
straight	155	1	4.008 455
straight	180	1	4.008 456
straight	210	1	4.008 457
straight	255	1	4.008 458
straight	300	1	4.008 459



3 Double ended spatulas chattaway, 18/10 steel

Polished stainless steel with one end flat and the other with a bent flat end.

Spatula width mm	Length mm	PK	Cat. No.
9	100	1	4.008 452
9	130	1	4.008 453
9	150	1	9.150 815
9	180	1	9.150 816
9	210	1	9.150 817



4 LLG-Macro Spoon Spatula, PP

Consists of a spoon on one side which allows easy transfer of sample, while the other end is a flat construction with a knife edge which can be used to draw salt or breaking crystals.

Length mm	PK	Cat. No.
150	25	6.267 390
180	25	6.267 391
210	25	6.267 392



5 Sampling spoon, PP

Length 180 mm. Long handle reaches easily into jars, bottles and other confined areas; minimizes the potential of personal contact with sampled material. Safe for food, drug and cosmetic contact. Autoclavable.

Capacity ml	Width mm	PK	Cat. No.
1.25	20	1	9.150 643
2.46	25	1	9.150 644
4.93	30	1	9.150 645
14.79	39	1	9.150 646



Tools/Spoons, Spatulas

1 2 Powder spatula smartSPATULAS®, PP

Single use polypropylene lab tools made to increase productivity and reduce costly contamination errors. They offer a clean alternative to metal spatulas.

- Size related designs to fit perfectly with standard 0.5, 1.5/2.0, 15 and 50 mL tubes
- Ideal for dispensing or sample collection of powders or soft solids
- Shatter resistant in liquid nitrogen and resistant to dilute acids and bases and can be used with hot liquids
- Anti-static, sterile and Eco-friendly versions available
- Autoclavable and complies with FDA standards for food contact

For tubes ml	Description	Colour	Diam.	Length	Figure	PK	Cat. No.
			mm	mm			
0.2	Micro Antistatic	Natural	3.5	140	a	300	6.256 896
15/1.5/2.0	Eco	Natural	7.0	140	b	300	6.256 894
15/1.5/2.0	Standard	Blue	7.0	210	c	300	6.256 893
15/1.5/2.0	Standard	Natural	7.0	210	d	300	6.256 895
15/1.5/2.0	Standard sterile	Natural	7.0	210	d	100	6.256 898
50	Macro	Green	1.0	310	e	150	6.256 897

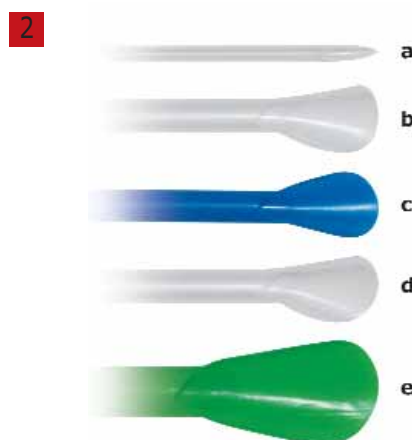
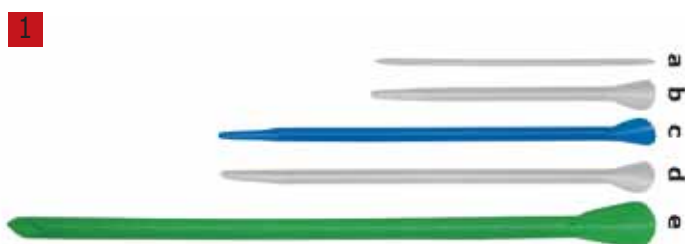

3 Spatulas with wooden handle, stainless steel

Flexible, long blade as outlined below.

Blade width mm	Blade length mm	Length mm	PK	Cat. No.
14	75	165	1	9.220 607
18	100	190	1	9.220 610
20	130	230	1	9.220 613
22	150	250	1	9.220 615
27	165	275	1	9.220 616
32	200	310	1	9.220 620
38	250	365	1	9.220 625
42	300	415	1	9.220 630



4 Tongue depressors, wooden

Wooden.

Length mm	PK	Cat. No.
150	100	9.165 101



5 Stirring rods, Soda-lime glass

Soda-lime glass. With flame-polished ends.

Ext. diam. mm	Length mm	PK	Cat. No.
6	200	10	9.197 424
6	250	10	9.197 426
7	300	10	9.197 431
8	300	10	9.197 433
9	300	10	9.197 435

1 Scissors dissecting, stainless steel

Excellent grade polished stainless steel with fine sharps points and close shanks.
 Available as 2 types:
 - straight body form
 - curved body form

Type	Length mm	PK	Cat. No.
straight body form	130	1	6.236 264
curved body form	130	1	9.204 222



2 LLG-Scissors general purpose, stainless steel

Excellent grade polished stainless steel with straight form and close shanks.
 Available as 3 types:
 - sharp/sharp points
 - blunt/blunt points
 - sharp/blunt points

Type	Length mm	PK	Cat. No.
sharp - sharp	130	1	6.237 703
sharp - sharp	160	1	9.204 231
blunt - sharp	130	1	9.204 232
blunt - blunt	130	1	9.204 234
blunt - blunt	160	1	9.204 235



3 Surgical scissors, stainless steel

Straight, closed shanks. Point/blunt.

Length mm	PK	Cat. No.
130	1	9.204 220



Universal scissors, stainless steel, Plastic handle

Length mm	Description	PK	Cat. No.
130	Straight	1	4.008 515 4
160	Straight	1	4.008 516 5
200	Curved	1	4.008 517 6

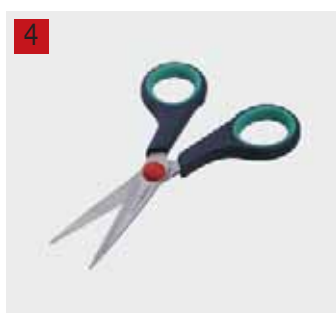

4.008 515

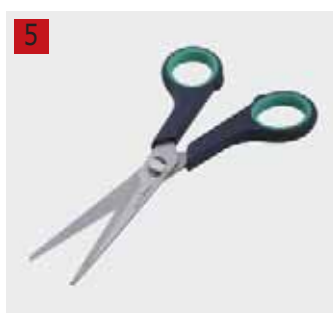

4.008 516

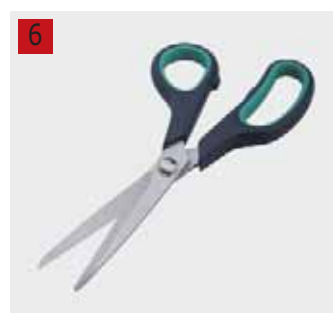

4.008 517

Tools/Workshop tools



9.160 656

LLG-All-round Cutter with rubber grip

An easy and comfortable handling is ensured by the ergonomically shaped, grip. The break-off device is integrated into the grip section of the ABS plastic casing. Comes with a metal blade guide and auto-lock system. Both cutters will be delivered on blister cards including 2 spare cutting blades.



9.160 657

Type	PK	Cat. No.
LLG-All-round Cutter 18 mm	1	9.160 656 1
LLG-All-round Cutter 9 mm	1	9.160 657 2
Replacement blade for LLG-All-round Cutter 18 mm	10	9.160 658
Replacement blade for LLG-All- round Cutter 9 mm	10	9.160 659



LLG-Multi-purpose tool

Blue anodised housing with stainless steel screws. Specifications: Needlenose Pliers, Wire Cutters, Wire Stripper, Knife, Saw Knife, Saw, Screwdriver, Crosshead Screwdriver, Bottle/Can Opener, File. Supplied completely with Nylon Belt Pouch. Dimensions: 100 x 45 x 20 mm

Type	Weight g	PK	Cat. No.
LLG-Multi-purpose tool	230	1	9.160 000



LLG-Universal slicer

Heavy duty scissor for cutting almost all material even also thin layers of steel. Cutting blade is manufactured from high quality hardened stainless steel. Spring supported ergonomic plastic handle with safety lock offers easy and secure use.

Length mm	PK	Cat. No.
185	1	6.267 394



LLG-Glass markers, diamond-tipped

Writing diamond for writing on glass. Available as a pen with retractable tip or mounted on a wooden handle.

Type	Size	PK	Cat. No.
With wooden grip	1	1	9.032 920
Pen type	1	1	9.032 930



LLG-Torch

Sturdy torch with 12 energy saving LED lights for ultra-bright light. Made from metal with practical hand strap incl. 3 x 1.5 V AAA batteries. Dimensions (Dia. x L): 30 x 120 mm

Type	PK	Cat. No.
LLG-Torch	1	9.961 000

1 LLG-Forceps assortment, 4-parts, chromium-nickel steel

LLG-Forceps assortment, 4-parts, chromium-nickel steel (1.4301) in synthetic leather bag including:
 1 Sharp forcep, curved, 115 mm
 1 Thumb forcep, 115 mm
 1 Forcep with guide pin straight, 130 mm
 1 Coverglas forcep, 115 mm
 1 Synthetic leather bag, 6 subjects 100 x 175 mm

Description	PK	Cat. No.
LLG-Forceps assortment, 4-parts	1	9.160 394



2 One-time tweezers, PS, sterile

One-time tweezers, 120 mm, sterile, PS, anatomic

Description	PK	Cat. No.
One-time tweezers, sterile	100	6.270 262



3 LLG-Forceps, 18/10 steel

Blunt-straight.

Length mm	PK	Cat. No.
105	1	4.008 471
115	1	4.008 472
130	1	4.008 473
145	1	6.255 826
160	1	4.008 474
200	1	4.008 475
250	1	4.008 476
300	1	4.008 477
115*	1	4.008 478
130*	1	4.008 479
145*	1	4.008 480
160*	1	4.008 481

* with tooth



4 LLG-Dissecting forceps, stainless steel 420

Manufactured from premium grade polished stainless steel with fine sharp points and sprung flutes.
 Available as 2 types:
 - straight body form
 - curved body form

Length mm	PK	Cat. No.
105	1	4.008 482
115	1	9.171 121
130	1	9.171 122
150	1	9.171 123
160	1	4.008 483
200	1	4.008 484
105*	1	4.008 485
115*	1	9.171 124
130*	1	6.236 683

* curved



Tools/Forceps - Scoops

1

1 LLG-Cover glass forceps, self-locking, stainless steel

Stainless steel 4301

Form	Length mm	PK	Cat. No.
Straight	105	1	9.160 380
Curved	105	1	9.160 381

2

2 LLG-Cover glass forceps, type Kühne, stainless steel

Stainless steel 4301

Form	Length mm	PK	Cat. No.
Curved	115	1	9.160 386
Curved	130	1	9.160 387
Curved	145	1	9.160 388
Straight	115	1	9.160 391
Straight	130	1	9.160 392
Straight	145	1	9.160 393

3

3 Forceps, PMP

White. Polymethylpentene (PMP). Elastic. With pointed ends. Comfortable to use. Self-sprung. Autoclavable (121 °C).

Length mm	PK	Cat. No.
115	1	9.171 411
145	1	9.171 414

4

4 LLG-Dispensing scoops, PE-HD

For heavy industrial use. Suitable for foodstuff.

Capacity ml	Length mm	PK	Cat. No.
250	250	1	9.201 091
500	300	1	9.201 092
1000	350	1	6.240 471
1500	400	1	9.201 093

5

5 Dispensing scoops, Aluminium

Capacity ml	Length Scoop mm	Overall length mm	PK	Cat. No.
42	80	135	1	9.201 113
105	113	185	1	9.201 118
140	120	210	1	9.201 121
260	145	250	1	9.201 125
340	155	265	1	9.201 126
555	185	310	1	9.201 131
675	220	350	1	9.201 135
1510	270	400	1	9.201 140
3000	300	430	1	9.201 143

1 Bunsen burners with needle valve

DIN 30665. Air regulation,

Description	Height mm	Weight g	PK	Cat. No.
Natural	155	220	1	9.018 361

1



2 Bunsen burner with needle valve

DIN 30665. Air regulation, low-voltage.

Rubber sucker base (Art. Nr. 9.018 360) please order separately.

Type	Height mm	Weight g	PK	Cat. No.
Natural with needle valve	155	220	1	9.018 365

2



3 Accessories for Bunsen burner

Type	PK	Cat. No.
Rubber sucker base for bunsen burner	1	9.018 360

3



4 Teclu burners with needle valve

Acc. to DIN 30665, with air regulation, with low flame.

Type	Height mm	Weight g	PK	Cat. No.
Natural	155	260	1	9.018 375
Propane	155	260	1	9.018 376

4



5 Gas cartridge

220 g/400 ml. With safety valve. Provides approx. 3 hours use. EN 417: 2012. 70 % butane, 30 % propane.

Type	PK	Cat. No.
Gas cartridge	1	9.018 364

5



Burner for cartridges

With needle gas valve and air regulator.

Only for the gas cartridge 9.018 364.

Height mm	Type	PK	Cat. No.
136	Burner for cartridges, Teclu, without cartridge	1	9.018 363 ⁶
136	Burner for cartridges, Bunsen, without cartridge	1	9.018 370 ⁷

6

7



9.018 363

9.018 370

8 Piezoelectric gas lighter, Clipper

Piezoelectric.

Type	PK	Cat. No.
Piezoelectric gas lighter, Clipper	1	9.018 820

8



Heating/Beaker tongs - Tripod



1 Beaker tongs, chromated steel

Beaker tong of 300 mm length is made out of chromated steel. Insulated jaws are used to hold all types of beakers.

For	Length mm	Temp. range max. °C	PK	Cat. No.
beakers volume up to 1000ml	300	120	1	6.237 287



2 Flask tongs, chromated steel

Chromated steel flask tong - 300 mm length with insulated jaws, used to hold all types of flasks.

For	Length mm	Temp. range max. °C	PK	Cat. No.
flasks volume up to 2000ml	300	120	1	4.008 397



3 Crucible tongs, chromated steel

With bow and flutes.

Length mm	PK	Cat. No.
300	1	4.008 441



4 Basin tongs, chromated steel

Length mm	PK	Cat. No.
300	1	4.008 440



5 Tripod stand, chrome plated steel

Chrome plated steel. Tripods are meant to be used in conjunction with wire gauze, triangles or a sand bath. Holding ring with 150 mm diameter can be reduced to 125 mm with the supplied reduction attachment.

Description	Diam. mm	PK	Cat. No.
total height 200 mm	125	1	6.242 704
adjustable height min 200 mm/max 300 mm	150	1	4.008 512

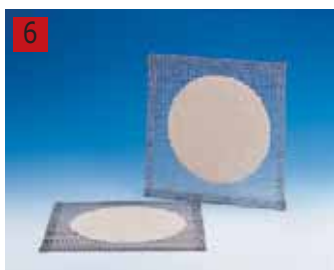

6 Wire gauzes

Steel wire with round ceramic centre. Sizes as outlined below.

Width mm	Depth mm	PK	Cat. No.
120	120	1	9.033 632
160	160	1	9.033 636
200	200	1	9.033 640

1 Safety gas hoses, rubber, without reinforcement

According to DIN 30664 section 1. Without cable armour. Connecting line for connecting between safety gas connection fitting according to DIN 3383-4 and gas burners for laboratories according to DIN 30665 section 1.
 For all gases according to DVGW worksheet G 260, at pressures up to 100 mbar and temperatures up to 70 °C.
 Installations according to DVGW-TRGI 2008 and DVGW worksheet G 621. DVGW Reg.-No. NG-4607AU2366.
 Supplied per metre.

Int. diam. mm	Wall thickness mm	PK	Cat. No.
10	2.00	1	9.018 970



2 Tubing

Red. Rubber (NR). Durometer 45 Shore A.
 Supplied per metre or in standard coils of 25 m.

Int. diam. mm	Wall thickness mm	PK	Cat. No.
5	1.50	1	9.205 170
5	2.00	1	9.205 171
6	1.50	1	9.205 173
6	2.00	1	9.205 174
7	1.50	1	9.205 179
7	2.00	1	9.205 180
8	2.00	1	9.205 184
9	2.00	1	9.205 187
10	2.00	1	9.205 192
12	2.50	1	9.205 195



3 Vacuum tubing, rubber

Red. Rubber (NR). Durometer 45 Shore A. Supplied per metre or standard coils of 25 m.

Int. diam. mm	Wall thickness mm	PK	Cat. No.
4	4.00	1	9.205 804
5	5.00	1	9.205 805
6	5.00	1	9.205 806
7	4.00	1	6.077 239
7	5.00	1	9.205 807
8	5.00	1	9.205 808
8	6.00	1	6.053 348
10	5.00	1	9.205 809



Tubing/Plastic



1

1 Tubings RAULAB FG® SLIDETEC, Silikon

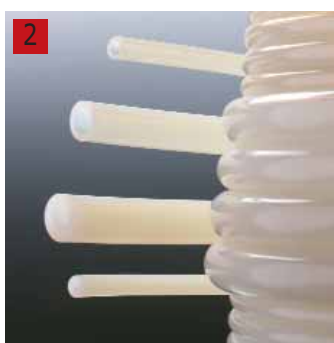

Suitable for food use, untalcummed, according to BfR XV (Silicone) and FDA 177.2600. Original roll 25 meters. Discharge per meter. Durometer 60 ±5 Shore A to DIN 53505.

Int. diam. mm	Ext. diam. mm	Wall thickness mm	PK	Cat. No.
2.00	4.0	1.00	1	9.205 001
3.00	7.0	2.00	1	9.205 005
6.00	9.0	1.50	1	9.205 011
6.00	10.0	2.00	1	9.205 012
7.00	10.0	1.50	1	9.205 013
7.00	11.0	2.00	1	9.205 280
10.00	14.0	2.00	1	9.205 018
12.00	16.0	2.00	1	9.205 020



2

2 Tubing, Silicone

Silicone rubber (VMQ), transparent, hardness 60 Shore A, food grade, temperature-resistant from -60 to +200 °C (short term up to +260 °C), suitable for peristaltic pumps. BFR XV, FDA CFR 21 § 177.2600, EP-Europ. Pharmacopoeia/DAB, biocompatibility: Cytotoxicity (USP Class 1-6), Hemolysis, Pyrogenicity, Sensitization, Dermatological Irritation, Implantation (90 days) according to ISO 10993-1. Supplied per meter.

Int. diam. mm	Ext. diam. mm	Wall thickness mm	Length/ Roll m	PK	Cat. No.
1.50	3.50	1.00	25	1	9.205 233
8.00	11.00	1.50	25	1	9.205 282

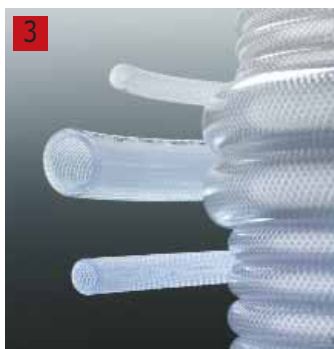
To determine outer diameter, add wall thickness twice to internal diameter
(Eg: 9.205 243: internal diam. 2.00 mm. + wall thickness 0.30 mm x 2 = outer diameter 2.6 mm).

3

3 Fabric-reinforced tubing, PVC

Transparent. Supplied per metre or in standard coils of 50 M. PVC with terylene mesh reinforcement. Certified by German TÜV with due regard to regulatory of DIN EN ISO 5774:2008. Proofed by BGVO directive 2002/72/EC bis 2008/39/EC for food contact. Durometer 77 Shore A.

Int. diam. mm	Ext. diam. mm	Wall thickness mm	PK	Cat. No.
6.00	12.0	3.00	1	9.205 816
8.00	14.0	3.00	1	9.205 818
10.00	16.0	3.00	1	9.205 820
12.50	18.5	3.00	1	9.205 823

4

4 Tubings RAUSIL FG, silicone



Suitable for food use, talc-powdered, according to BfR XV (Silicone) and FDA 177.2600. Original roll 25 meters. Discharge per meter. Durometer 55 ±5 Shore A to DIN 53505.

Int. diam. mm	Ext. diam. mm	Wall thickness mm	PK	Cat. No.
1.00	3.0	1.00	1	9.205 000
2.00	6.0	2.00	1	9.205 002
3.00	6.0	1.50	1	9.205 259
4.00	6.0	1.00	1	9.205 265
4.00	7.0	1.50	1	9.205 266
5.00	7.0	1.00	1	9.205 269
5.00	8.0	1.50	1	9.205 010
8.00	12.0	2.00	1	9.205 015
9.00	13.0	2.00	1	9.205 017

1 Tubing, PVC

Approved by BGVO directive 2002/72/EC and 2008/39/EC for food contact.

Approved by KTW-C directive - Germany Federal Environment Agency for use in cold water. Durometer 77 Shore A.

Price per metre.

Int. diam. mm	Ext. diam. mm	Wall thickness mm	PK	Cat. No.
2.00	4.0	1.00	1	9.205 345
3.00	5.0	1.00	1	9.205 358
3.00	6.0	1.50	1	9.205 359
4.00	6.0	1.00	1	9.205 365
4.00	7.0	1.50	1	9.205 366
5.00	7.0	1.00	1	9.205 369
5.00	8.0	1.50	1	9.205 370
6.00	8.0	1.00	1	9.205 372
6.00	9.0	1.50	1	9.205 373
6.00	10.0	2.00	1	9.205 374
7.00	10.0	1.50	1	9.205 379
7.00	11.0	2.00	1	9.205 380
8.00	11.0	1.50	1	9.205 382
8.00	12.0	2.00	1	9.205 384
9.00	12.0	1.50	1	9.205 386
9.00	13.0	2.00	1	9.205 387
10.00	14.0	2.00	1	9.205 392
12.00	16.0	2.00	1	9.205 394
15.00	19.0	2.00	1	9.205 397
18.00	22.0	2.00	1	9.205 398



2 Tubing, PTFE

Highly chemical resistant and withstands temperatures from -200 °C to +260 °C. Supplied per metre.

Int. diam. mm	Ext. diam. mm	Wall thickness mm	PK	Cat. No.
0.50	1.0	0.25	1	9.205 608
0.50	1.6	0.55	1	9.205 609
0.80	1.6	0.40	1	9.205 616
1.00	1.6	0.40	1	9.205 619
1.00	2.0	0.50	1	9.205 621
1.50	2.1	0.30	1	9.205 630
1.60	3.2	0.80	1	9.205 634
2.00	3.0	0.50	1	9.205 644
2.00	4.0	1.00	1	9.205 645
3.00	4.0	0.50	1	9.205 657
3.00	5.0	1.00	1	9.205 658
4.00	6.0	1.00	1	9.205 665



3 Tubing Norprene® A 60 G

Black, Thermoplastic elastomer, Shore A 61. Temperature range -60 to +135 °C. Suitable for use as tubing for peristaltic pumps. Very high endurance. Resistant to many aggressive chemicals. Heat and ozone resistant (does not turn brittle). Fills the performance gap between single elastomers (such as EPDM, chloroprene) and expensive polymers (viton, silicone).

Supplied per metre or in standard coils of 15 m.

Int. diam. mm	Ext. diam. mm	Wall thickness mm	PK	Cat. No.
1.60	4.8	1.60	1	9.206 941
3.20	6.4	1.60	1	9.206 944
4.80	8.0	1.60	1	9.206 951
6.40	9.6	1.60	1	9.206 956
6.40	11.2	2.40	1	9.206 957
8.00	11.2	1.60	1	9.206 961
8.00	12.8	2.40	1	9.206 962
9.50	12.7	1.60	1	9.206 967



4 LLG-Hose cutter

A perfect tool to cut even thick hoses with external diameter from 6.0 mm to 25 mm. The cut edges of tubings with the tube cutter are always clean and flat. Offers a clean and sharp cut of tubings in a few seconds. Hose cutter has a two end blade which can be turned when one gets blunt and the other sharp side used.

Description	PK	Cat. No.
for diam. 6 - 25 mm	1	6.267 395





1 Plug tubing connectors, PE

PE. Comprising of two pull-apart sections, similar to conical ground joint. Not suitable for high pressure applications. Autoclavable.

For tubing bore mm	Length mm	PK	Cat. No.
3 to 5	57	1	9.207 261
5 to 7	65	1	9.207 262
7 to 9	70	1	9.207 263
9 to 12	75	1	9.207 264
11 to 14	80	1	9.207 265



2 Y-tubing connectors, PP

Transparent, PP. Y-shape. Autoclavable.

For tubing bore mm	Length mm	PK	Cat. No.
3 to 4	24	1	9.207 200
4 to 5	35	1	9.207 203
6 to 7	54	1	9.207 205
8 to 9	64	1	9.207 207
10 to 11	74	1	9.207 208
12 to 13	87	1	9.207 210



3 120° Y connectors, PP

Autoclavable.

Diam. mm	Tubing i.d.	PK	Cat. No.
min./max.	mm		
4/5/6	1.5	1	9.207 231
6/7/8	2.7	1	9.207 232
8/9/10	4.7	1	9.207 233

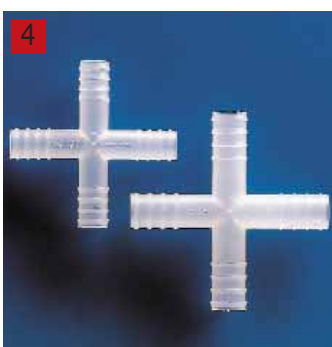

4 4 way connectors, PP

Autoclavable.

Diam. mm	Tubing i.d. mm	PK	Cat. No.
6.0	2.7	1	9.207 242
10.0	7.0	1	9.207 244
12.0	8.0	1	9.207 245



5 L-tubing connectors, PP

Transparent, PP. L-shape. Autoclavable.

For tubing bore mm	Length mm	PK	Cat. No.
6 to 7	25	1	9.207 253
8 to 9	30	1	9.207 254
10 to 11	36	1	9.207 255

1 Non-return valves, PP

Prevents water back-flow when pressure falls. Useful for any tubing system and vacuum line. Maximum safe working pressure: 2 bar, minimum: 0.07 bar at room temperature (20 °C).

Int. diam. mm	PK	Cat. No.
8-10	1	9.303 028
10-15	1	9.303 029



2 Mediclips, PP

Robust PP. For flat widths of dialysis tubing up to 40 mm.

Type	PK	Cat. No.
Mediclips	1	9.206 300



3 Keck tubing clamps KT

Thermoplastic polyester (PBT). Continuous control of flow rate in tubing with just one finger.

For external tube diam. mm	Colour	PK	Cat. No.
4.5	red	1	9.205 904
6.0	yellow	1	9.205 906
10.0	blue	1	9.205 910
14.0	red	1	9.205 914



4 Tubing clamp

Clamp is molded of strong, durable plastic with serrated jaws 27mm long. Attach at any point on tubing without disconnecting tubing. Designed to be operated with one hand, the clamp locks closed and opens when the locking tab is released.

- Autoclavable
- One hand open and close operation
- For use on tubing with a wall thickness of 0.82 mm or thinner
- When not in use, the circular opening (approximately 6 mm diameter) at hinge end allows clamp to remain attached to tubing having 6-10 mm OD with little to no restriction in flow
- Overall length is 59 mm

Type	PK	Cat. No.
Tubing clamp	12	6.200 838



WILO- Curved tubing clamps

SK range. Steel. Large, plastic knurled nut with embedded brass screwthread insert which closes a metal bracket onto the curved tubing stirrup. Clamping range 10 mm to 30 mm. Temperature resistant up to 150 °C. Knurled nut made of aluminum or moulded plastic.

Jaw opening mm	Colour	PK	Cat. No.
10	aluminum	1	9.180 210 5
15	black	1	9.180 215 6
20	black	1	9.180 220 7
30	black	1	9.180 230



➔ Sample bags please see page 47.

General laboratory aids/Clamps - Labels



1 Tubing clamps

Hose clips, with hexagonal head.

Jaw opening mm	Material	PK	Cat. No.
10 - 5,5	Chrome-nickel steel	1	9.207 510
12 - 8,5	Chrome-nickel steel	1	9.207 512
14 - 9,5	Chrome-nickel steel	1	9.207 514
17 - 12	Chrome-nickel steel	1	9.207 517
21 - 16	Chrome-nickel steel	1	9.207 521
25 - 20	Chrome-nickel steel	1	9.207 525
29 - 24	Chrome-nickel steel	1	9.207 529



2 Adhesive label tape Write-on™, writable

Specially coated plastic tape with adhesive backing. Makes labels of any length. Can be used with any pens. Excellent adhesion to glass, metal, PE, etc. Resistant to humidity, as well as acids and alkali solutions in weak concentrations. Leaves no residue when removed.

Temperature resistance

up to 157 °C: 30 min

up to 80 °C: 24 h

Resistant to -80 °C.

Autoclavable at 121 °C.

Colour	Width mm	Length m	PK	Cat. No.
White	12.7	36.4	1	9.040 379
White	19.0	36.4	1	9.040 380
White	25.4	36.4	1	9.040 381
White	12.7	54.6	1	9.040 351
White	19.0	54.6	1	9.040 352
White	25.4	54.6	1	9.040 353
Red	12.7	36.4	1	9.040 336
Red	19.0	36.4	1	9.040 341
Red	25.4	36.4	1	9.040 346
Yellow	12.7	36.4	1	9.040 337
Yellow	19.0	36.4	1	9.040 342
Yellow	25.4	36.4	1	9.040 347
Green	12.7	36.4	1	9.040 338
Green	19.0	36.4	1	9.040 343
Green	25.4	36.4	1	9.040 348
Blue	12.7	36.4	1	9.040 339
Blue	19.0	36.4	1	9.040 344
Blue	25.4	36.4	1	9.040 349
Orange	12.7	36.4	1	9.040 340
Orange	19.0	36.4	1	9.040 345
Orange	25.4	36.4	1	9.040 350



3 Adhesive tape dispenser Write-On™ Economy

Provides a smooth writing surface, making labeling easy and fast. When marked tape is advanced and cut off on the serrated edge, a fresh length of label tape is positioned on the writing platform. Plastic cutting edge is moulded into the housing. Various widths and colours of tape rolls can be mixed together on the spindles, which accommodates 5 or more 12 to 19 mm narrow rolls or 4 x 25 mm wide rolls. Spindles are easily removed from the unit for loading and unloading and can be adjusted to hold either 25 or 75 mm core diameter rolls.

- Includes three plastic separating discs to assure smooth, snag free dispensing for up to four rolls of tape (additional discs on request).
- Moulded-in pen holder wells on the dispenser help to keep writing instruments handy
- Ideal for use with the full line of Write-On™ Tapes, which are available in 6 colors and 3 widths.
- Includes mounting holes for secure attachment to a benchtop (screws not included).
Can also be attached to vertical surfaces using Wall Mount Adapter
- Dimensions (W x D x H): 302 x 143 x 105 mm

Items supplied: Adhesive tape dispenser incl. 1 roll of 12 mm white Write-On™ Labeling Tape

Type	PK	Cat. No.
Write-On™ Economy	1	9.040 389

1 Adhesive label tape

Manufactured from colored paper with special resin adhesive that resists to moisture and most solvents. Can be used between -80 to + 140 °C temperature range. Also withstands steam autoclaving cycle and gamma irradiation. Adheres to any clean surface including PTFE coated surfaces and peels off without leaving any sticky residue. Accepts writing from almost all pen types such as pencil, ball point pen, solvent ink marker etc. Markings remain absolutely legible under the most demanding laboratory conditions.

Supplied as white, color or as pack of 6 different colors matching the universal hazard color codes yellow for chemical reactivity, blue for health hazards, green for safety, red for flammability, orange tape for biohazard and white for general use.

Colour	PK	Cat. No.
Yellow, blue, green, red, orange, white	6	6.286 757
White	1	6.286 758



2 Adhesive tape dispenser

Suitable for holding and releasing the tape to be cut to users desire. The core perfectly fits to the inner diameter of the tape and keeps the tape rigid. Platform includes a writing surface. Finger holes on the platform enables quick release of the tape and accelerates the cutting step. Featured with a cut-off edge for efficient cutting of the tape. A weighted base with non-skid pads prevent sliding or lifting.

Overall dimensions: 155 x 250 x 100 mm. Cutting platform dimensions: 155 x 110 mm.

Type	PK	Cat. No.
Adhesive tape dispenser	1	6.286 759



3 Label remover, Solvent 50

SOLVENT 50 is a highly effective label solvent for the effortless removal of self adhesive labels on the basis of natural orange terpenes. It works on the adhesive and quickly and gently dissolves adhesive labels on glass, porcelain, metal, wood, foil and cardboard. SOLVENT 50 also removes sticky residue of any kind, such as tar spots or glue residue from stickers. Check compatibility when using on plastics. Not suitable for polystyrene.

Density: Spray: 0.74 g/cm³ (20 °C)
Jerrycan: 0.83 g/cm³ (20 °C)

Ignition point: Spray: < 0 °C
Jerrycan: 46 °C

Evaporation rate: Spray and jerrycan: 94 (DIN 53170 Ether = 1).

Type	Capacity L	PK	Cat. No.
Solvent 50, Spray can	0.20	1	9.412 810
Solvent 50 Super, Spray can, with dosing brush	0.20	1	6.270 569



General laboratory aids/Documenting

1

1 2 Permanent markers, edding 404/400

Low-odour, smudge-proof water-resistant and quick drying. Refillable. Replaceable tips. For labelling, painting and writing on virtually all materials, including glass, metal and plastics. Alcohol-based ink without toluene/xylene. Colours as outlined below.

2

Type	Colour	Bullet Nib mm	PK	Cat. No.
404	Black	0,75	1	9.050 451
404	Red	0,75	1	9.050 452
404	Blue	0,75	1	9.050 453
404	Green	0,75	1	9.050 454

3

3 Lab markers, 1.0 mm point

Writes on dry or wet surfaces including glass, plastic, china and metal. Colour does not run in water or alcohol when used normally, but can be washed off.

Colour	PK	Cat. No.
black	1	9.050 601
red	1	9.050 602
blue	1	9.050 603
green	1	9.050 604

4

4 LAB-Marker II, 0.6 mm, highly permanent

With hard wearing, fine fibre point. For labelling most materials (plastic, metal, china, glass etc.). Particularly suitable for tissue and cell culture applications. The non-toxic ink is dye, bleach and wash-resistant and also resists solvents including alcohol and xylene.

Colour	PK	Cat. No.
black	1	9.050 611
red	1	9.050 612

5

5 LLG-Lab Notebook

For recording research data, experimental procedures, and design ideas. Use these notebooks to keep your information safe and well organised. Numbered, acid-free, grid pages include spaces for title, project number, book number, date, and witness signature. Lined notebooks feature college ruled pages for easy report writing. Covers are waterproof and chemical-resistant. All notebooks contain periodic and conversion tables in the back. Admissible as court evidence when used as prescribed by law. Measures: 216 x 279 mm.

Type	Description	Colour	PK	Cat. No.
grid	100 pages	black	1	9.050 750
grid	200 pages	blue	1	9.050 751
lined	200 pages	red	1	9.050 752

6

6 Molecular model system Molymod®

The Molymod® system is an original, unique system of high quality molecular models. The set consists of a variety of atom parts and links designed to make a large number of possible structures relevant to a specific chemistry subject or use, e.g. Biochemistry, Organic or Inorganic. All sets are fully compatible. Atom parts are made of solid clouded plastic spheres. They are available with holes from 1 to 6 in the usual angular orientations.

Type	Description	PK	Cat. No.
Introductory Set	48 atoms, 62 links	1	9.883 101
Organic Set, large	111 atoms, 140 links	1	9.883 103
Biochemistry Set, large	257 atoms, 160 links	1	9.883 107
Organic Set, small	50 atoms, 64 links	1	9.883 108
Inorganic/Organic Set, large	106 atoms, 86 links	1	9.883 104

1 LLG-Laboratory jack, stainless steel

Plates made of stainless steel. Top plate with Ø 10 mm hole. With non-skid rubber feet. Acc. to DIN 12897.

Width mm	Depth mm	Min. height mm	Max. height mm	Max. stat. kg	PK	Cat. No.
200	200	60	270	25	1	9.117 220



2 Rectangular retort stand bases, enamel, coated steel plate

Highly stable laboratory stand due to the steel rectangular base which is stove enamel coated. With an M10 threaded hole in the middle of one short side. Rubber support feet prevents the stand from sliding. Laboratory stands are supplied without support rod. Please select the suitable rod from "support rods".

Width mm	Depth mm	Weight g	PK	Cat. No.
130	210	1725	1	6.242 701
150	300	2830	1	4.008 486
200	315	4000	1	4.008 487



3 Tripod retort stand bases chromated steel

Highly stable laboratory stand due to the steel tripod base which is stove enamel coated. With an M10 threaded hole in the middle. Rubber support feet prevents the stand from sliding. Laboratory stands are supplied without support rod. Please select the suitable rod from "support rods".

Foot length mm	Weight g	PK	Cat. No.
115	805	1	4.008 488
150	1050	1	4.008 489



4 Support rods galvanised steel

Galvanised steel. External diameter 12 mm. With or without M10 thread.

Type	Length mm	PK	Cat. No.
With thread	600	1	4.008 490
With thread	750	1	6.242 703
With thread	1000	1	4.008 491



5 Support rods 18/10 stainless steel

18/10 stainless steel. 12 mm external diameter.

Length mm	Ext. diam. mm	Thread	PK	Cat. No.
600	12	M 10	1	4.008 492
750	12	M 10	1	4.008 493
1000	12	M 10	1	4.008 494



6 7 Support ring, steel

Steel. With or without bosshead, as outlined below.

Type	Ext. diam. mm	Weight g	PK	Cat. No.
without bosshead	70	157	1	6.900 428
without bosshead	100	216	1	6.900 429
without bosshead	130	230	1	6.201 068
with bosshead	70	210	1	6.076 309
with bosshead	100	236	1	9.223 900
with bosshead	130	266	1	9.223 901



General laboratory aids/Stands, Fittings



1 Bosshead		PK	Cat. No.
Malleable cast iron with lacquered chrome finish. DIN 12895. With lug screw.			
Jaw opening mm			
16.5		1	9.224 254
20		1	6.225 278
36		1	6.802 614



2 Bosshead		PK	Cat. No.
18/10 steel. To DIN 12895. Material number 4301. Electrolytically polished, with heart screw. Angle 90°.			
Jaw opening mm			
16.5		1	9.224 252



3 Bosshead, malleable iron		PK	Cat. No.
Double bosshead malleable iron, epoxy coated.			
Description	Jaw opening mm		
with M8 brass thumb bolt	20	1	9.223 902



4 Cross bosshead, cast steel		PK	Cat. No.
Chrome plated cast steel. Suitable for frame works and fixing perpendiculars. Can be moved vertically and horizontally along the rods.			
Description			
suitable for rods 12 mm		1	9.224 278



5 Cross bosshead		PK	Cat. No.
Malleable cast iron with chrome finish. DIN 12895. 90° and 180° angle with lug screw.			
Jaw opening mm			
16.5		1	9.224 264



Clamp, 2 prongs

Chrome plated cast steel with two PVC coated prongs for gently holding the objects. Two separately adjustable clamps enable perfect control of holding pressure and precise positioning of the objects. Clamps can be opened and closed smoothly with a grip width of 0-50 mm.

Available as 2 types:

- with solid stem of 12 mm rod diameter, the holding angle and distance from the support rod can be adjusted by a separate bosshead.
- with swivel mechanism which enables the object to freely swivel 360° and lockable at any angle. Complete with a integral bosshead, usable for rods maximum diameter of 21 mm.



6.237 648



9.224 401

Description	Jaw opening mm	PK	Cat. No.
solid stem	0 to 50	1	6.237 648 1
swivel	0 to 50	1	9.224 401 2

3 Retort clamps

Standard to DIN 12894. With round jaws.

Jaw opening mm	Shaft length min. mm	Material	PK	Cat. No.
25	150	Malleable cast iron, chromed	1	9.224 470
40	150	Malleable cast iron, chromed	1	9.224 471
60	150	Malleable cast iron, chromed	1	9.224 472
80	180	Steel, zinc coated	1	6.306 164



4 Universal clamp, with cork

Prongs with cork.

Jaw opening mm	Shaft length mm	Material	PK	Cat. No.
0 to 80	180	Aluminium, DIN pattern	1	9.224 501
0 to 80	150	18/10 steel	1	9.224 502



Burette clamp

- Metal burette clamps are made out of steel and can hold one burette at a time. Graduations and meniscus line of the burette are clearly visible. They can be used on support rods of 10 - 12 mm diameter.
- Polypropylene burette clamp can hold one burette at a time. Graduations and meniscus line of the burette are clearly visible. They can be used on support rods of 10 - 12 mm diameter.

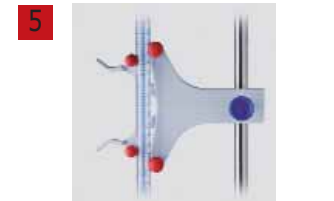

4.008 313



6.240 474

Description	PK	Cat. No.
Burette clamp, metal	1	4.008 313 5
Burette clamp, PP	1	6.240 474 6

General laboratory aids/Bags, Foils



1 Aluminium foil

Suitable for many laboratory applications. Resistant to liquids and gases. Ideal for sealing and wrapping of bottles and flasks. Good thermal conductivity, heat resistant.

Description	Width mm	Length m	Thickness µm	PK	Cat. No.
Dispenser box	600	100	30	1	6.027 813
Refilling roll	300	100	30	1	6.060 382
Dispenser box	300	100	30	1	6.070 786
Dispenser box	450	100	30	1	6.070 787
Refilling roll	500	100	30	1	6.075 999
Refilling roll	300	150	15	1	6.076 184
Dispenser box	300	150	15	1	6.076 250
Short roll	450	10	30	1	6.076 351
Refilling roll	600	100	30	1	6.510 476
Refilling roll	450	100	30	1	7.510 894
Short roll	300	20	13	1	9.106 013
Short roll	450	10	15	1	9.106 015
Dispenser box	450	150	15	1	9.106 102
Dispenser box	300	100	13	1	9.106 103
Refilling roll	450	150	15	1	9.106 104
Dispenser box	500	100	30	1	9.106 105
Short roll	300	10	15	1	9.106 106
Short roll	300	10	30	1	9.106 107
Roll	500	200	50	1	9.106 205



2 Round aluminium discs

Interleaved with tissue paper. Foil thickness 0.03 mm.

Diam. mm	PK	Cat. No.
80	1000	9.106 208
100	1000	9.106 210
120	1000	9.106 212
130	1000	9.106 213
150	1000	9.106 215



3 Aluminium containers, round

Capacity ml	Top diam. mm	Bottom diam. mm	Fill height mm	PK	Cat. No.
28	64	51	13	100	9.106 240
110	80	56	34	100	9.106 241
110	99	70	25	100	9.106 242
125	96	78	24	100	9.106 261
280	114	58	50	50	9.106 263

4 5 6 Aluminium containers, square, with lid

Capacity ml	Dimensions top (D x W) mm	Dimensions bottom (D x W) mm	Fill height mm	PK	Cat. No.
251	128 x 103 *	93 x 67	34	100	6.226 802
500	191 x 127 *	156 x 92	29	60	9.106 266

* With lid.



1 LLG-Surface protector DescProtect

DescProtect is a durable paper which quickly absorbs liquid spills. The PE-coated base layer stops liquids reaching the work surface.

- stays flat, does not ripple or curl to de-stabilise vessels
- white surface can be written on using pens or pencils
- rapid absorption of liquid spills
- excellent fluid protection
- no contamination of work surfaces or laboratory cabinets
- suitable for school laboratories, wet chemistry, industry

Surface protection paper with two layers:

- Layer 1: Highly absorbent carrier paper, sucks up spilled toxic or radioactive liquids quickly
- Layer 2: Wetness impermeable polyethylene layer, protection for lab workbenches, trays or chemical cabinets
- Additional advantages: impermeable cover in animal cages, ideal in humidity chambers for atmospheric regulation

Type	Size	PK	Cat. No.
Sheets	460 mm x 570 mm	50	9.160 270
Spool	400 mm x 50 m	1	9.160 271



2 SAROGOLD® foil

Extra-strong foil. PVDC-based. Good barrier properties protects the user against contact with dangerous substances (e.g. ethidium bromide or contaminated isotopes) from the sealed material and it is therefore suitable for covering sequencing gels in Electrophoresis applications.

- does not stick, easy to unravel
- with cutter
- non-flammable
- self-extinguishing
- microwaveable

Film thickness:	11.5 µm
Permeability in the visible area:	90 %
UV-filtering:	300 Å
IR-permeability:	88 %
Width:	300 mm
Length:	300 m

Type	Size	PK	Cat. No.
SAROGOLD®	300 mm, roll 300 m	1	9.106 460

2



3 Stand-up Freezer bags

Polar One. With tear-resistant seam.

Capacity Litres	Width mm	Length mm	PK	Cat. No.
1	190	240	40	9.033 251
3	250	320	30	9.033 252
6	290	470	20	9.033 253

3



4 LLG-Disposal bags, PE

Transparent. PE. Without seal.

Width mm	Length mm	Thickness mm	PK	Cat. No.
100	150	0.05	100	9.404 128
150	200	0.05	100	9.404 130
200	350	0.05	100	9.404 140
250	400	0.05	100	9.404 150
250	400	0.10	100	9.404 151
300	500	0.05	100	9.404 152
300	500	0.10	100	9.404 153

4



General laboratory aids/Bags, Foils



1 LLG-Pressure-seal bags with write on patch, PE

Transparent. PE. With rim channel seal that can be opened and closed repeatedly, and write-on patch.

Width mm	Length mm	Thickness mm	PK	Cat. No.
40	60	0.05	100	9.404 176
70	100	0.05	100	9.404 173
80	120	0.05	100	9.404 179
100	150	0.05	100	9.404 171
120	170	0.05	100	9.404 172
160	220	0.05	100	9.404 177
200	300	0.05	100	9.404 178



2 LLG-Pressure-seal bags, PE

Transparent. PE. With rim channel seal that can be opened and closed repeatedly.

Width mm	Length mm	Thickness mm	PK	Cat. No.
80	120	0.05	100	9.404 160
100	150	0.05	100	9.404 161
120	170	0.05	100	9.404 162
150	220	0.05	100	9.404 163
180	250	0.05	100	9.404 164
200	300	0.05	100	9.404 165
220	310	0.05	100	6.304 307
250	350	0.05	100	9.404 166
300	400	0.05	100	9.404 167



3 PARAFILM® M sealing film

Can be stretched up to 200 % and clings around irregular shapes and surfaces. Parafilm® M is resistant to many polar substances such as saline solutions, inorganic acids and alkaline solutions for up to 48 hours (After this time it may become brittle). Parafilm® M conforms to general FDA requirements if used below 55 °C.

Melting temperature: 60 °C
 Continued use temperature: -45 °C to +50 °C
 Stretching ability: 200 %

Type	Width mm	Length m	PK	Cat. No.
PARAFILM®M	50	75	1	9.170 003
PARAFILM®M	100	38	1	9.170 002
PARAFILM®M	100	75	1	9.170 005
PARAFILM®M	500	15	1	9.170 004



4 LLG-Dispenser for PARAFILM® M, orange, ABS

PARAFILM® M feeds through easily and is easy to cut using the safety cutting device.
 For rolls with width up to 100 mm.

Type	PK	Cat. No.
PARAFILM®M dispenser, ABS	1	9.170 006

1 LLG-Safety Eyeshields *basic*

- CE approved to EN166 and EN170
- Perfect for visitors as well as over goggles for spectacles wearers
- Integrated side lens with venting, 180° visual field
- Frame made of tested hypo-allergenic material
- 100 % UV protection (up to 380 nm)
- Weight: 43 g

Colour	Lens	PK	Cat. No.
Clear	Clear, uncoated, 2-1.2 U 1 F CE	10	9.006 002

2 LLG-Safety Eyeshields *basic +*

- CE approved to EN 166 and EN 170
- Economic Safety Eyeshields ideal for essential protection
- 180° field of vision
- Frame made of tested hypo-allergenic material
- 100 % UV protection (up to 380 nm)
- Especially light
- Weight: 23 g

Colour	Lens	PK	Cat. No.
Clear	Clear, uncoated, 2-1.2 U 1 F CE	10	6.290 868

3 LLG-Safety Eyeshields *classic*

- CE approved to EN166 and EN170
- Integrated side-lenses with vents, 180° field of vision
- Frame made of tested hypo-allergenic material
- Side arms adjustable in length and inclination
- 100 % UV protection (up to 380 nm)
- Weight: 34 g only

Colour	Lens	PK	Cat. No.
Blue	Clear, anti-scratch lens, 2C-1.2 U 1 F CE	1	9.006 001

4 LLG-Safety Eyeshields *classic light*

- CE approved to EN166 and EN170
- Integrated side-lenses with vents, 180° field of vision
- Frame made of tested hypo-allergenic material
- Side arms adjustable in length
- 100 % UV protection (up to 380 nm)
- Weight: 29 g only

Colour	Lens	PK	Cat. No.
light blue	clear, AF, AS, 2C-1.2 U 1 FT CE	1	9.006 011

LLG-Safety Eyeshields *evolution and evolution+*

- CE approved to EN166, EN170 and EN 172 for tinted lens
- Panoramic wrapping lens
- 180° field of vision
- Frame made of tested hypo-allergenic material
- Side arms adjustable in length
- Nose pad and arm tips are made from soft, mouldable material offer optimal comfort and individual customisation
- Rubber eyebrow protection for greater shock absorption
- 100 % UV protection (up to 400 nm)
- Lightweight: 30 g only

Type	Colour	Lens	PK	Cat. No.
Evolution	black/green	clear, anti-scratch plus and anti-fog lens plus, 2C-1.2 U 1 FT CE	1	9.006 010 5
Evolution+	black/green	tinted, anti-scratch plus and anti-fog lens plus, 2C-3/5-3.1 U 1 FT N CE	1	9.006 000 6



9.006 010



9.006 000

1

1 LLG-Safety Eyeshields *blue*

- CE approved to EN166 and EN170
- Panoramic wrapping lens
- 180° field of vision
- Frame made of tested hypo-allergenic material
- Side arms adjustable in length and inclination
- Soft ends made with outsert moulding
- 100 % UV protection (up to 380 nm)
- Lightweight: 29 g only

Colour	Lens	PK	Cat. No.
blue/silver	Clear, anti-scratch lens, 2C-1.2 U 1 F CE	1	9.006 012

LLG-Safety Eyeshields *lady*

- CE approved to EN166 and EN170
- Panoramic wrapping lens
- 180° visual field
- Frame made of tested hypo-allergenic material
- Temples with rubber tips, adjustable in length and inclination
- Nosepad and terminal tips made from soft, moldable material offer optimal comfort and individual customisation
- 100 % UV protection (up to 400 nm)
- Weight 25 g only

Colour	Lens	PK	Cat. No.
white/green	clear, AF+, AS+, 2C-1.2 U 1 FT KN CE	1	9.006 007 2
white/pink	clear, AF+, AS+, 2C-1.2 U 1 FT KN CE	1	9.006 008 3
black/green	clear, AF, AS, 2C-1.2 U 1 FT CE	1	9.006 009 4

2

9.006 007

3

9.006 008

4

9.006 009

5

5 LLG-Panoramic Eyeshield

- CE approved to EN166 and EN170
- Linear and compact design
- Can be worn over any prescription spectacles
- Wide, fully adjustable headband
- Frame made of tested hypo-allergenic material
- 100 % UV protection (up to 380 nm)
- Weight: 84 g

Colour	Lens	PK	Cat. No.
blue	clear, polycarbonate, 2C-1.2	1	6.291 832

1 LLG-Dispenserbox, Acrylic Glass

With hinged lid. For clean storage of laboratory tools, e.g. laboratory goggles, gloves or other small items. Wall mounting possible (mounting material included)

Description	Dimensions (W x D x H) mm	PK	Cat. No.
LLG-Dispenserbox	216 x 216 x 200	1	6.286 593

1



2 Lens Cleaning Tissues

Non-abrasive cleaning for delicate optical surfaces. Lint-free fibre paper is ideal for cleaning lens and optics. 5 Booklets with 100 sheets.

Width mm	Length mm	PK	Cat. No.
100	150	500	9.056 899

2



3 4 Mini-Ultrasonic Cleaner LLG-uniSONIC 1

For convenient cleaning of goggles or smaller laboratory instruments. Eco-friendly, only needs warm water. By ultrasonic sound millions of small air bubbles are generated. Combined with a very high pressure these achieve a fast, efficient and effortless cleaning.

- Ready to use, no assembly required
- Automatic 3-minute-operation can be stopped anytime
- Removable lid
- Stainless steel tank

Specifications

Capacity:	approx. 340 ml
Frequency:	45 kHz
Cleaning Performance:	30 Watt
Outer Dimensions (W x D x H) approx.:	200 x 115 x 115 mm
Dimensions tank (W x D x H) approx.:	155 x 80 x 40 mm
Weight:	630 g
Power supply:	220 - 240 V, 50 Hz
Warranty:	3 years

Type	PK	Cat. No.
LLG-uniSONIC 1	1	6.263 560



1

1 LLG-Disposable Protective Visors

- Transparent visor made of acetate
- With anti-fog coating
- Head holder made of TPU-foam with elastic
- Ideal as a disposable protection, for example, for visitors
- Can be worn over prescription glasses and protective masks
- Weight: 22 g

Description	PK	Cat. No.
LLG-Disposable Protective Visors, clear lens, elastic headband, anti-fog	20	6.284 812

2

2 LLG-Protective Visor with chin protection

- Transparent 1 mm Flip-up protective polycarbonate visor
- 100 % UV protection (to 380 nm)
- Head holder adjustable with elastic band
- Height adjustable head holder
- Can be worn over glasses and protective masks
- Weight: 224 g

Description	PK	Cat. No.
LLG-Face visor with chin protection, clear PC shield, elastic headband	1	6.284 958

3

3 Surgical Face Masks, Profil Elastic Bands

- soft, non-irritating, elastic bands
- three-ply, non-fibre-glass, filter material
- integral nose bridge
- bacterial filtration efficiency 99 %
- EN 14683 type II R, CE

Colour	PK	Cat. No.
white	50	6.264 475
green	50	6.264 631
blue	50	9.405 162



Protection level classification

These filter classes are the minimum requirement and simply serve as a guide. It is the wearers' responsibility to make sure the breathing apparatus conforms to the requirements in terms of hazardous materials and concentration before use!

FFP 1: for particles that are neither toxic nor associated with fibrosis. For protection up to 4 times the corresponding threshold limit value

FFP 2: for hazardous or harmful particles, vapour and smoke; filters for solid and liquid particles with a medium filtering level. For protection up to 10 times the corresponding threshold value

FFP 3: for poisonous particles, vapour and smoke; filters for solid and liquid aerosols with a high filtering classification. For protection up to 30 times the corresponding threshold limit value

Respirators ClassicLine, Folding Masks

ClassicLine fine dust masks are our advantageous standard programme. They offer a reliable and professional protection.

- CE marked
- acc. to EN 149:2001

Description	Protection-level	PK	Cat. No.
without valve	FFP 1	10	9.005 731 1
with valve	FFP 2	10	6.258 155

1



9.005 731

Respirators ClassicLine, Moulded Masks

ClassicLine fine dust masks are our advantageous standard programme. They offer a reliable and professional protection.

- CE marked
- acc. to EN 149:2001

Description	Protection-level	PK	Cat. No.
without valve	FFP 1	10	9.005 695
without valve	FFP2	10	9.005 696
with valve	FFP 1	10	9.005 697
with valve	FFP2	10	9.005 698 2
with valve	FFP3	10	9.005 699

2



9.005 698

3 LLG-Universal dispenser, Acrylic glass

LLG-Universal dispenser with hinged lid and removal opening. For clean storage of laboratory accessories, e.g. disposable hoods, overshoes or other small items. Wall mounting possible (mounting material included).

3



Description	Dimensions mm	PK	Cat. No.
LLG-Universal dispenser	206 x 216 x 213	1	6.289 563

Standards for safety gloves



EN 374	Protective hand gloves against chemicals and microorganisms;
EN 388	Protective hand gloves against mechanical risks
EN 407	Protective hand gloves against thermal risks (heat and/or fire) note instructions for use
EN 420	Protective hand gloves against ionising radiations and radioactive contamination
EN 421	Protective hand gloves against cold
EN 511	Not harmful to food stuffs
AQL-Value:	acceptable quality level for penetration

1 | 2 LLG-Disposable Gloves *classic*, Latex, Powder-Free

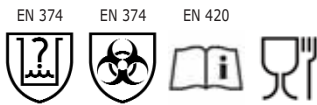

The ideal glove for all applications which require a high tactile sensitivity.

- Skin-friendly
- Excellent tactile sensitivity
- High durability due to special formulation
- **Cat. III Low Chemical resistant.** AQL 1.5.
- Thiuram free, reduced risk of contact eczemas

According to ASTM 1671 (ISO 16604) for protection against viral penetration.
According to EN 420. Suitable for food handling.

Glove shape:	flat with rolled edge, ambidextrous
Material:	natural latex
Colour:	natural white
Outside:	textured fingers
Inside:	powder free
Size/Length:	S, M, L, XL/med. 240 mm
Thickness (measured in double layer):	0.20 mm

Size	PK	Cat. No.
S	100	9.006 383
M	100	9.006 384
L	100	9.006 385
XL	90	9.006 386

1



2



1 | 2 LLG-Disposable Gloves *ergo*, Nitrile, Powder-Free

EN 374

EN 374

EN 420



Disposable protective glove in nitrile that when worn, combines the comfort and "feel" of latex with the physical and chemical endurance of nitrile. With no risk of allergies. The ideal glove for all applications requiring high tactile sensation and protection against chemicals.

- **Thin - very comfortable to wear**
- Excellent tactile sensitivity - similar to latex
- Tried and tested quality product made of nitrile
- Excellent resistance to skin irritants in foodstuffs
- Specially formulated for a more resilient glove
- For single use in applications with an increased need for safety when handling chemicals
- Free from phthalates/softeners and allergenic latex proteins
- Easy to wear and particularly skin-friendly through special finishing process
- Colour lavender blue
- Suitable for areas subject to HACCP standards
- **Cat. III low chemical resistant. AQL 1.5**

According to ASTM F 1671 (ISO 16604) for protection against viral penetration.

According to EN 420 and DIN EN ISO /IEC 17025, DIN EN 45011. Suitable for food handling.

Glove shape:	flat with rolled edge (ambidextrous)
Material:	nitrile
Colour:	lavender blue
Outside:	textured fingers
Inside:	powder-free halogenated
Size/total length:	XS, S, M, L, XL/med. 240 mm
Thickness (measured in double layer):	0.12 mm

Size	PK	Cat. No.
XS	200	9.006 370
S	200	9.006 371
M	200	9.006 372
L	200	9.006 373
XL	180	9.006 374

1**2**

1 2 LLG-Disposable Gloves, *standard*, Nitrile, Powder-Free



Disposable protective glove in nitrile with enhanced comfort in use and greater chemical protection - the standard glove for the laboratory.

- **Comfortable to wear**
- **Good tactile sensitivity**
- Tried and tested quality product made of nitrile - excellent resistance to skin irritants in foodstuffs
- More resilience through special formulation
- For single use in applications with an increased need for safety when handling chemicals
- Free from phthalates/softeners and allergenic latex proteins
- Easy to don and particularly skin-friendly through special finishing process
- Colour blue - suitable for areas subject to HACCP standards
- **Cat. III Low Chemical resistant. AQL 1.5.**

According to ASTM F 1671 (ISO 16604) for protection against viral penetration.

According to EN 420, EN 455, EN 374-2: specified, EN 374-3: Class 6 Sodium Hydroxide 40 %. Suitable for food handling.

Glove shape:	flat with rolled edge (ambidextrous)
Material:	nitrile
Colour:	blue
Outside:	textured
Inside:	powder-free halogenated
Size/total length:	S, M, L, XL/med. 240 mm
Thickness (measured in double layer):	0.16 mm

Size	PK	Cat. No.
S	100	9.006 375
M	100	9.006 376
L	100	9.006 377
XL	90	9.006 378

1



2



1 | 2 LLG-Disposable Gloves, *standard long*, Nitrile, Powder-Free

EN 374 EN 374 EN 420



Disposable protective glove in nitrile with enhanced comfort in use and greater chemical protection - the standard glove for the laboratory.

- **For forearm protection, 300 mm length**
- Very comfortable to wear
- Tried and tested quality product made of nitrile - excellent resistance to skin irritants in foodstuffs
- More resilience through special formulation
- For single use in applications with an increased need for safety when handling chemicals
- Free from phthalates/softeners and allergenic latex proteins
- Easy to don and particularly skin-friendly through special finishing process
- Colour blue - suitable for areas subject to HACCP standards
- **Cat. III Low Chemical resistant. AQL 1.5.**

According to ASTM F 1671 (ISO 16604) for protection against viral penetration.

According to EN 420. Suitable for food handling.

Glove shape:	flat with rolled edge (ambidextrous)
Material:	nitrile
Colour:	blue
Outside:	textured
Inside:	powder-free halogenated
Size/total length:	S, M, L, XL/med. 300 mm
Thickness (measured in double layer):	0.16 mm

Size	PK	Cat. No.
S	100	6.270 366
M	100	6.270 367
L	100	6.270 368
XL	90	6.270 369

1



2



1 2 LLG-Disposable Gloves *strong*, Nitrile, Powder-Free



Disposable, nitrile, heavy-walled, protective glove offering an enhanced resistance time against many chemicals. A protective glove for applications with higher safety requirements, but providing greater comfort in use than traditional chemical protective gloves.

- Very sturdy - higher material thickness

- Tried and tested quality product made of nitrile - excellent resistance to skin irritants in foodstuffs
- More resilience through special formulation
- For single use in applications with an increased need for safety when handling chemicals
- Free from phthalates/softeners and allergenic latex proteins
- Easy to don and particularly skin-friendly through special finishing process
- Colour blue - suitable for areas subject to HACCP standards

Cat. III low chemical resistant. AQL 1.5.

According to ASTM F 1671 (ISO 16604) for protection against viral penetration.

According to EN 420. Suitable for food handling.

Glove shape:	flat with rolled edge (ambidextrous)
Material:	nitrile
Colour:	blue
Outside:	textured
Inside:	powder-free halogenated
Size/total length:	S, M, L, XL/med. 240 mm
Thickness (measured in double layer):	0.22 mm

Size	PK	Cat. No.
S	100	9.006 379
M	100	9.006 380
L	100	9.006 381
XL	90	9.006 382

1



2



1 LLG-Glove Dispenser, Coated Wire

Dispenser for 3 boxes (pict. 1), with top (left illustr.) or front insert (right illustr.). Mounting material included.
 Dispenser for 1 box, with top or side slot. Mounting material included.

For	Description	Width mm	Depth mm	Height mm	PK	Cat. No.
3 Boxes, 250 x 80 mm	front insert	260	90	440	1	9.405 369
3 Boxes, 255 x 85 mm	top insert	265	95	400	1	9.405 370
1 Box, 72 mm depth	top/side insert	180	85	140	1	9.405 371 ²
1 Box, 135 x 85 mm	side insert	265	100	155	1	9.405 372 ³

1



2



9.405 371

3



9.405 372

LLG-Glove Dispenser for 1 or 3 Boxes, Acrylic Glass

LLG glove dispensers are suitable for glove packs with the dimensions approx. 240 x 75 x 125 mm, with front insert or side slot. High-quality, sturdy design. Mounting material included.

Description	For	Width mm	Depth mm	Height mm	PK	Cat. No.
side slot, sturdy material	1 Box	250	85	136	1	6.286 594 ⁴
front insert, flexible material	3 Boxen	260	90	405	1	9.405 373 ⁵
side slot, sturdy material	3 Boxen	280	87	460	1	9.405 374 ⁶

4



6.286 594

5



9.405 373

6



9.405 374

1

1 Chemical Protection Glove Duo-Mix 405, Neoprene/Latex

Flexible safety glove made of natural latex and neoprene offering tactile sensitivity and light chemical protection. Anatomical shape. Better grip due to embossed texture. Good dexterity. 1 pair per pack.

Length: 330 mm
 Thickness: 0.7 mm
 Colour: Yellow/Blue
 CE: **Cat. III**

Size	PK	Cat. No.
S (7)	1	9.005 308
M (8)	1	9.005 309
L (9)	1	9.005 310
XL (10)	1	9.005 311

2

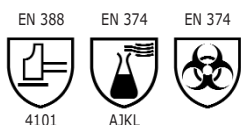
2 Chemical Protection Glove Ultranitrile 492, Nitrile

Green nitrile glove with cotton flock liner. Anatomical shape. Good grip finish on palm and fingers. High mechanical resistance. Excellent chemical protection against alcohols, oils, greases and hydrocarbons. Thin material for increased dexterity. Comfort, due to the quality of the flock-lining. **Cat. III**
 Packing with 1 pair.

Length: 320 mm
 Thickness: 0.38 mm
 Colour: green
 CE: **Cat. III**

Size	PK	Cat. No.
XS (6)	1	6.224 148
S (7)	1	9.005 170
M (8)	1	9.005 180
L (9)	1	9.005 190
XL (10)	1	9.005 200
XXL (11)	10	4.658 276

3

3 Undergloves, Cotton

100 % Cotton. Monofilament, ideal to wear under chemical protection gloves. 1 pair per pack. **Cat. I**

Size	Length cm	PK	Cat. No.
6	25	1	6.235 155
7	25	1	7.623 809
8	25	1	9.005 222
9	25	1	7.625 555
10	25	1	7.623 881
11	25	1	7.623 810
12	25	1	9.005 223
13	25	1	6.224 187

1 Safety Gloves Clavies®, Heat Protection up to 232 °C

Soft, pliant, all-cotton terry cloth gloves are superb for handling hot objects out of the autoclave or oven, or for other heat protection in the lab, school or industry. Note: Gloves are not waterproof and should not be used to handle dry ice. CE approved.

Length gauntlet mm	Overall length mm	PK	Cat. No.
130	330	1	9.005 271
280	470	1	9.005 272



2 Safety Gloves Nomex®, Heat Protection up to 250 °C

Very supple, offering excellent movement. Knitted construction, without seams. Temperature resistant up to 250 °C. 1 pair per pack. **Cat. II**

Description	Size	PK	Cat. No.
Gloves, standard	9 - 10	1	9.005 250
Gloves with forearm protection	9 - 10	1	9.005 260



3 Safety Gloves uvex K-Basic extra, Cut and Heat-Protection up to +250°C



This coarse-knitted glove made of 100 % Kevlar® is lined with cotton, making it ideal for protecting the wearer against heat and cuts.

The combination of Kevlar® and cotton guarantees good heat insulation and enables the handling of objects up to +250 °C without losing anything in terms of cut resistance. 1 pair per pack.

Characteristics:

- Very good protection against cut injuries
- Additional cotton cladding
- Comfortable to wear

Applications: metal processing, automotive industry, glass industry, foundries

Length: 220 mm to 270 mm
 Colour: yellow
 EN: 388 (1 3 4 X)

Size	PK	Cat. No.
8	1	9.414 660
10	1	9.414 661



4 Hand Protectors Hot Hand®

Made of thick-walled silicone.

Safe, non-slip protection against very hot or cold surfaces.

Measures 10 cm x 19 cm with durable silicone rubber construction that remains flexible from -57 °C to +260 °C.

End pockets accept thumb and fingers to grasp objects.

Mitts have multiple studs with concave tips thus providing secure grip on virtually all hot/cold surfaces.

Type	PK	Cat. No.
Hot Hand®	1	9.119 900



1



1 Cleansing Lotion Ivrxo® Soft V

- mild skin cleansing lotion for lightly soiled hands
- good skin tolerance because of a balanced cleanser combination
- very skin-friendly
- adapted to the natural pH-value of human skin
- remoisturizing
- soap-free

Description	PK	Cat. No.
1000 ml	1	9.191 156
Dosing pump for 1000 ml- hard bottle	1	9.191 160

2



2 Skin Protection Cream LINDESA® PROFESSIONAL with Beeswax

Non-greasy, quickly absorbed. The cream strengthens the defensive functions of the skin, preventing skin damage from external pollution and soothes irritation. Smooths and cleans without leaving a residue. LINDESA® PROFESSIONAL gives the skin elasticity and suppleness through its special caring agents. The sense of touch is not affected. For low levels of soiling it provides protection against weak acids, alkalis and organic substances.

Description	PK	Cat. No.
50 ml	1	9.191 159
100 ml	1	9.191 161

3



3 LLG-Laboratory coat, 100% cotton

- Very solid material, excellent wearing comfort
- Snap fasteners (press buttons); easy and quick to open
- With fold-down collar
- One outside breast pocket and two side pockets
- Washable up to 60 °C
- Ladies coat with stitched-down back belt

Material: 100 % cotton
 Colour: White
 Weight: 220 g/m²

Description	Size	PK	Cat. No.
Ladies coat	36/38	1	9.414 342
Ladies coat	40/42	1	9.414 343
Ladies coat	44/46	1	9.414 344
Mens coat	44/46	1	9.414 345
Mens coat	48	1	9.414 346
Mens coat	50	1	9.414 347
Mens coat	52	1	9.414 348
Mens coat	54	1	9.414 349
Mens coat	56	1	9.414 350

4



4 LLG-Disposable Visitor Gowns, PP

White PP nonwoven 30 g/m², universal size with shirt collar and elastic at the wrists, latex-free, without pocket, 4 push buttons

Description	PK	Cat. No.
LLG-Visitors gown	50	6.282 796

5



5 LLG-Working and Chemical Protective Apron Guttasyn®, PVC/PE

Made from PVC with reverse side made of PE. Material thickness: 0.5 mm. Side and neck ribbons made of woven plastic fabric and securely attached to the apron with welded PVC eyelets. Easy to clean, hygienic and dirt-repellent PVC surface. Liquids will not be absorbed but drain off the surface. Machine wash at 60 °C. Colour: white. Acc. to 89/686/EWG (Cat. III), EN 467 and EN 14605:2005.

Width mm	Length mm	PK	Cat. No.
800	1000	1	9.414 415
800	1200	1	9.414 417
1000	1200	1	9.414 419

1 LLG-Disposable Protective Suits, PP

White PP non-woven 30 g/m², with hood and zipper, elastic band on the hood and on the wrists and ankles, latex-free.

Size	PK	Cat. No.
L	10	6.282 791
XL	10	6.282 792
XXL	10	6.282 793

1



2 LLG-Overall tritex® pro White, Type 5/6, PP

Particle-tight, and to a limited extent, spray-tight chemical protective clothing.

The coverall made of 3-layer SMS material (spunbond-meltblown-spunbond) is robust and breathable. A meltblown filter membrane is embedded between two durable outer layers. Comfortable to wear, this coverall is a pleasant, protective companion in many work areas. Special features are the hood, the zipper cover strip, the back rubber element, and the arm and leg rubber elements.

- antistatic
- lint-free
- abrasion resistant
- breathable

Cat. III/CE 0624/Type 5/6

Coverall individually packed!

Size	PK	Cat. No.
M	5	6.266 640
L	5	6.266 641
XL	5	6.266 642
XXL	5	6.266 643
XXXL	5	6.266 644

2



3 LLG-Disposable Bouffant Caps, PP

PP nonwoven 10 g/m², universal fit Ø 52 cm, with all-around elastic, latex-free

Colour	PK	Cat. No.
green	100	6.282 788
white	100	6.282 789
blue	100	6.282 790

3



4 LLG-Disposable Protective Sleeves, PE

PE film with elastic, latex-free, length 40 cm

Colour	Thickness µm	PK	Cat. No.
blue	20	100	6.282 797
white	20	100	6.282 798
blue	40	100	6.282 799

4



Protective clothing/Overshoes - Identification of hazards/GHS Warning Labels



1 LLG-Disposable Shoe Covers, CPE

Blue embossed CPE film, 30 µm, with elastic, latex-free, universal size, length 41 cm

Type	PK	Cat. No.
LLG-Disposable Overshoes, CPE	100	6.282 795



2 LLG-Disposable Shoe Covers, PP, with CPE sole

White PP non-woven, 38 g/m² with blue, non-slip sole CPE, 38 µm, with elastic, latex-free, universal size, length 40 cm

Type	PK	Cat. No.
LLG-Disposable Overshoes, CPE sole	50	6.282 794



3 4 5 6 LLG-GHS Warning Labels, Self-Adhesive, Roll in Dispenser Box

Dispenser box of 250 labels. These labels are produced using an extremely resistant 100µm PE film. Due to their special surface coating they are resistant to most solvents and excellent for indoor or outdoor use. The strong adhesive, although permanent, can be removed from glass containers without leaving any trace.

Trilingual signal word: German, English, French.
Available in 2 sizes.

Type	Description	Label	Dimensions mm	PK	Cat. No.
GHS 01	warning	exploding bomb	26 x 37	250	9.105 700
GHS 01	danger	exploding bomb	26 x 37	250	9.105 701
GHS 02	warning	flame	26 x 37	250	9.105 702
GHS 02	danger	flame	26 x 37	250	9.105 703
GHS 03	warning	flame over circle	26 x 37	250	9.105 704
GHS 03	danger	flame over circle	26 x 37	250	9.105 705
GHS 04	warning	gas cylinder	26 x 37	250	9.105 706
GHS 05	warning	corrosive	26 x 37	250	9.105 707
GHS 05	danger	corrosive	26 x 37	250	9.105 708
GHS 06	danger	skull and crossbones	26 x 37	250	9.105 709
GHS 07	warning	exclamation mark	26 x 37	250	9.105 710
GHS 08	warning	health hazard	26 x 37	250	9.105 711
GHS 08	danger	health hazard	26 x 37	250	9.105 712
GHS 09	warning	environment	26 x 37	250	9.105 713
GHS 01	warning	exploding bomb	37 x 52	250	9.105 720
GHS 01	danger	exploding bomb	37 x 52	250	9.105 721
GHS 02	warning	flame	37 x 52	250	9.105 722
GHS 02	danger	flame	37 x 52	250	9.105 723
GHS 03	warning	flame over circle	37 x 52	250	9.105 724
GHS 03	danger	flame over circle	37 x 52	250	9.105 725
GHS 04	warning	gas cylinder	37 x 52	250	9.105 726
GHS 05	warning	corrosive	37 x 52	250	9.105 727
GHS 05	danger	corrosive	37 x 52	250	9.105 728
GHS 06	danger	skull and crossbones	37 x 52	250	9.105 729
GHS 07	warning	exclamation mark	37 x 52	250	9.105 730
GHS 08	warning	health hazard	37 x 52	250	9.105 731
GHS 08	danger	health hazard	37 x 52	250	9.105 732
GHS 09	warning	environment	37 x 52	250	9.105 733

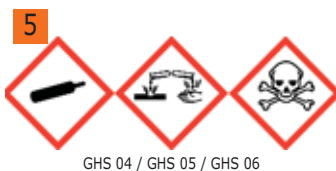

7 LLG-Labels with "Biohazard" Symbol

Ø 9.5 mm. Self-adhesive. Printing protected. For labeling of 0.5 to 2.0 ml microtubes that contains potentially hazardous substances. The labels have excellent heat resistance, chemical resistance and UV resistance and a very good adhesion to various materials, even on rough or non-polar surfaces such as on plastics with low surface energy. The material is UL certified. (File MH26760).
1000 labels per roll, in dispensing box.

Description	PK	Cat. No.
"biohazard" symbol	1000	9.105 740

1 Holder for Waste Sacks

Steel wire. Epoxy resin coating. With rubber feet.
Supplied with 100 PP waste sacks, transparent.

Warning:

Never place sharp objects such as hypodermic needles, etc., in plastic bags!
Always steam-sterilize bags unsealed. Injury hazard!

Int. diam. mm	Height mm	PK	Cat. No.
120	250	1	9.404 030

Delivery without waste sacks!



2 LLG-Autoclavable bags, PP

Constructed from very strong PP film with a broad seam at the bottom. For the disposal of contaminated labware.
When autoclaving, the neck of the bag must be left open. Film thickness: 50 µm.

Description	Size mm	auto-clavable at °C	Package contents	PK	Cat. No.
standard	200 x 300	134 °C	Dispenser box of 100 bags	100	9.404 099
standard	300 x 500	134 °C	Box of 500 bags	500	9.404 220
standard	400 x 780	134 °C	Box of 250 bags	250	9.404 221
standard	500 x 780	134 °C	Box of 250 bags	250	9.404 222
standard	600 x 800	134 °C	Box of 100 bags	100	9.404 103
standard	600 x 780	134 °C	Box of 250 bags	250	9.404 223
standard	700 x 1100	134 °C	Box of 250 bags	250	9.404 224
standard	700 x 1100	134 °C	Box of 75 bags	75	9.404 105
highly transparent	200 x 300	121 °C	Dispenser box of 100 bags	100	9.404 020
highly transparent	300 x 500	121 °C	Box of 500 bags	500	9.404 100
highly transparent	400 x 780	121 °C	Box of 500 bags	500	9.404 101
highly transparent	600 x 800	121 °C	Box of 500 bags	500	9.404 102
highly transparent	700 x 1100	121 °C	Box of 350 bags	350	9.404 104



LLG-Autoclavable Bags, PP, with Biohazard printing

Autoclavable bags imprinted with biohazard labelling. Made of polypropylene.
Strong side seams for securely holding items. Front write-on panel. Autoclavable.

Width mm	Length mm	Colour	Description	auto-clavable at °C	Thickness µm	PK	Cat. No.
310	660	transparent		121	45	50	9.404 050 3
415	600	transparent		121	45	50	9.404 051
610	810	transparent		121	45	50	9.404 052
500	600	red	with sterilisation indicator	134	50	200	6.285 813 4
630	890	red	with sterilisation indicator	134	50	200	6.285 814
910	1150	red	with sterilisation indicator	134	50	100	6.285 815



9.404 050



6.285 813

5 Waste Bags, PE

Capacity Litres	Width mm	Length mm	PK	Cat. No.
120	750	950	12	6.281 905



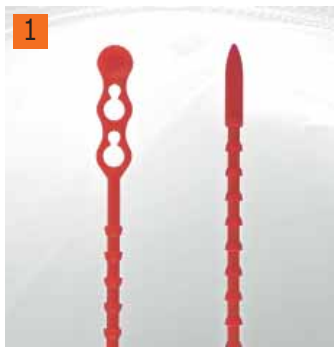

1 Quick-Lock Ties

Basic colour: natural and red Polyethylene, round, can be reopened. Further colours available on request.

Diam. mm	Length mm	PK	Cat. No.
3.5	120	1000	9.404 182
3.5	180	1000	9.404 184
3.9	240	1000	9.404 186

2 3 Disposal Container SHARPSAFE®, PP

Sharpsafe® offers a convenient range of disposal containers and accessories that meet high requirements of hygiene and safety. The disposal of waste at its source is thus very convenient and easy.

- Container consists of 2 parts: yellow base with semi-transparent cover, safe and quick installation by simply pressing and hearing 4 clearly audible "clicks"
- The Sharpsafe® 0.6 l is a pocket container and is already pre-assembled
- The Sharpsafe® 9 l is also available with a height of 498 mm for the disposal of long items such as serological pipettes
- Equipped with a carrying handle
- Secure one-hand use possible with different mounting accessories
- Wide opening for the disposal of large objects
- Disconnection for all types of needles (2 l to 7 l), insulin pens (2 l to 7 l) and scalpel blades (2 l to 9 l)
- Opening with integrated safety flap for additional protection (2 l to 7 l)
- The closure cap can be locked in the open position if required
- 2 locking positions: provisional and final, open simply by pressing the tab
- Maximum filling level clearly visible by a black line on the lid
- Safety distance between the container opening and the clear marking line of maximum filling level
- Inscription on a label fused into the container, label will not be removed by moisture or autoclaving
- Information on the label in different languages (see table)
- The empty and open container is autoclavable up to 134 °C for 18 minutes
- Sharpsafe® is conform to ADR, TRBA 250, ISO 23907: 2013, NFX30-500 and owner of the label NF302
- Country of origin: European Union

Type	Capacity ml	Dimensions (W x D x H) mm	Dimensions large opening mm	Labeling	PK	Cat. No.
0,6 L	580	108 x 52 x 224	40 x 30	FR/NL	1	9.264 210
1,0 L	1000	108 x 90 x 187	58 x 36	DE/FR/IT/ES/EN	1	9.264 211
2,0 L	2000	195 x 20 x 178	55 x 50*	DE/FR/IT/ES/EN	1	9.264 212
3,0 L	2600	197 x 120 x 205	55 x 50*	DE/FR/IT/ES/EN	1	9.264 213
4,0 L	4000	175 x 175 x 245	55 x 50*	DE/FR/IT/ES/EN	1	9.264 214
7,0 L	6700	175 x 175 x 380	55 x 50*	DE/FR/IT/ES/EN	1	9.264 215
9,0 L	9000	292 x 195 x 291	210 x 60	FR/NL	1	9.264 216
9,0 L h	8200	175 x 175 x 498	55 x 77	FR/NL	1	9.264 217

* Picture cover



4 Waste Containers

PP. With two nickel-plated handles for carrying and holding down the lid. Bin liners please order separately

Colour	Capacity	Dimensions (dia. x H) mm	PK	Cat. No.
black	23	350 x 450	1	4.658 539
black	46	430 x 570	1	4.658 538

LLG-Absorbent, oil and chemical binder, granules

Universal chemical and oil binder for all liquids, also for solvents. Very high absorption capacity (up to 1:75 of aqueous solutions). Almost dust-free granules with colour indicator: colour changes to yellow in contact with acids, to red in contact with alkalis. Disposal according to the pollutant recorded.

Capacity kg	Package	PK	Cat. No.
0.7	Laboratory bottle	1	6.283 036 1
1.5	Square handle bottle	1	6.283 037 2
5.0	Bucket	1	6.270 479 3

1



6.283 036

2



6.283 037

3



6.270 479

4 5 Portable Desiccator DURAPorter™, PC

Ideal for transporting biological and clinical samples, as well as instruments and products that you want to keep clean and dry under testing environmental conditions. Are light weight and easy to carry; they are ideal for moving samples that must be protected from humidity, dust and other environmental influence. The clarity of the DURAPorter™ enables the user to visibly check sample integrity, so that it can be opened using the right precautions.

- Polycarbonate construction are available in three colours for use/owner identification
- Silicone water-tight seal and three lid clasps provide secure closure
- Carry handle folds neatly into body space allowing the units to be stacked
- Lid opens a full 180°, allowing total access to contents and making it easier to clean
- Will accommodate 13 and 16 mm tubes in a 72-place one rack®, or similar sized/brand of rack
- Use the separators provided to create your own compartment sizes, or use empty to transport larger products and equipment
- Autoclavable

Matching rack (e.g. Cat. No. 9193 997, 9193 998) please order separately. Further colours available on request.

Type	Colour	Dimensions (l x w x h)	Material	PK	Cat. No.
		mm			
DURAPorter™	Clear with blue handles	380 x 196 x 160	PC	1	9.194 005
DURAPorter™	Yellow with yellow handles	380 x 196 x 160	PC	1	9.194 006
DURAPorter™	Red with red handles	380 x 196 x 160	PC	1	9.194 007

4



5



1 2 Laboratory Trolley, mobile comfort with box

Stable, multi-use trolley with parking brake.

Push-button collapsing/unfolding.

Made in Germany.

Load capacity:

Total: 60 kg

Upper shelf: 20 kg

Lower shelf: 40 kg

Dimensions

unfolded (L x W x H): 900 x 580 x 1020 mm

collapsed (L x W x H): 710 x 550 x 190 mm

Folding box dimensions

Inner dimensions (W x D x H): 335 x 495 x 258 mm

Outer dimensions (W x D x H): 350 x 500 x 260 mm

Type	PK	Cat. No.
Laboratory Trolley mobile comfort, incl. 1 clax folding box, 46 litres	1	9.148 100
clax folding box single, 46 litres	1	9.148 099

1



2



3



3 LLG Trolleys, Stainless Steel

Made of CNS 18/10, material no. 1.4301, with micro-polished surface. All shelves are produced with an all round raised profile edge. This prevents anything from slipping over the edge. The shelves are welded to the car. The load capacity per shelf is 80 kg. A noise-insulation mat is mounted on the bottom side of each shelf. The round tubes at the front edges are used as handgrips.

The trolleys are equipped with galvanized steel castors (4 swivel castors, 2 with brakes, castor diam. 125 mm) which are inserted in the tubular frame. Wall bumpers made of plastic (polyamide) on all four corners protect against damage.

Description	Width mm	Depth mm	Height mm	PK	Cat. No.
2 shelves, vertical spacing 585 mm	900	600	950	1	9.148 101
3 Shelves, vertical spacing 275 mm	900	600	950	1	9.148 104

LLG-Lab Stool



The extra-large seat provides optimum comfort. The solid black plastic star base and the upholstery edge protector that runs all the way round guarantee a long working life. The practical gas spring system with easy ring control allows a comfortable seat height adjustment.

- Resistant to all of the usual disinfectants and chemicals.
- Seat upholstery made of artificial leather (soft and comfortable, washable and antibacterial) or soft-touch PU foam (extremely robust, washable and antibacterial) in black.
- Extra-large seat: Encourages healthy posture and upright seating in the laboratory.
- Round front edge of the seat: Prevents blocked circulation in the thighs.
- Seat height adjustment by gas spring.
- Practical ring release: The height adjustment can be operated comfortably and easily in sitting position.
- Solid black plastic star base, flat design.
- The chrome-plated foot ring for the high chairs provides support through the wide tread area and can be easily and quickly adjusted in height.
- With certificate "Tested Safety" (GS mark).
- 10 years warranty, Made in Germany.

Type	Material	Description	Seat height adjustment mm	PK	Cat. No.
LLG-Lab Stool	PU Foam	Castors	460-630	1	6.287 757 1
LLG-Lab Stool	PU Foam	Glides, Foot Ring	570-850	1	6.287 759
LLG-Lab Stool	Artificial Leather	Castors	460-630	1	6.287 758
LLG-Lab Stool	Artificial Leather	Glides, Foot Ring	570-850	1	6.287 760 2

1



6.287 757

2



6.287 760

LLG-Lab Chair



Entry model for healthy sitting! The permanent contact backrest provides best support when working sitting down in the laboratory. The generously proportioned seat and backrest with integrated lumbar support provide additional support and therefore offer best laboratory ergonomics.

- Minimal joints: Hygienic design for easy cleaning and disinfection
- Resistant to disinfectants and chemicals: Resistant to all of the usual disinfectants and chemicals.
- Seat and backrest upholstery made of artificial leather (soft and comfortable, washable and antibacterial) or soft-touch PU foam (extremely robust, washable and antibacterial) in black.
- Quick adjustment: Every function can be operated comfortably and easy in sitting position.
- Seat height adjustment by gas spring.
- Permanent contact backrest.
- Backrest adjustable in height and inclination.
- Solid black plastic star base, flat design.
- The chrome-plated foot ring for the high chairs provides support through the wide tread area and can easily and quickly be adjusted in height.
- With certificate "Tested Safety" (GS mark).
- 10 years warranty, Made in Germany.

Accessories: Multifunctional armrests (pair): Adjustable in height, width and depth as well as swivelling.

Type	Material	Description	Seat height adjustment	PK	Cat. No.
			mm		
LLG-Lab Chair	PU Foam	Castors	440-620	1	6.287 750
LLG-Lab Chair	PU Foam	Glides, Foot Ring	580-850	1	6.287 751 ¹
LLG-Lab Chair	PU Foam	Stop and Go Castors, Foot Ring	620-890	1	6.287 752 ²
LLG-Lab Chair	Artificial Leather	Castors	440-620	1	6.287 753 ³
LLG-Lab Chair	Artificial Leather	Glides, Foot Ring	580-850	1	6.287 754
LLG-Lab Chair	Artificial Leather	Stop and Go Castors, Foot Ring	620-890	1	6.287 755
Armrests			-	1	6.287 756

1

6.287 751

2

6.287 752

3

6.287 753

LLG-Lab Standing Rest



The LLG-Lab Standing Rest is the practical solution for laboratory workplaces where people have to sit as well as to stand. To cope with this, it has a particularly wide range of heights that can be adjusted steplessly. Its ergonomic backrest and non-slip wave seat surface ensure that you feel completely safe and comfortable when you sit on it.

- Resistant to all of the usual disinfectants and chemicals.
- Seat upholstery made of soft-touch PU foam (extremely robust, washable and antibacterial) in black.
- Adheres to biosafety level BSL1 and BSL2 of the Directive for Biological Agents.
- GMP-conform.
- Rippled wave seat surface: Slip-resistant and offers a very good support and excellent ventilation.
- Integrated backrest: Best support of the lumbar region.
- Its low weight provides maximum mobility and easy handling in the laboratory.
- Seat height adjustment by gas spring.
- Seat swivel range of 360°.
- Solid black plastic star base, flat design.
- The chrome-plated foot ring provides support through the wide tread area and can be easily and quickly adjusted in height.

Type	Material	Description	Seat height adjustment mm	PK	Cat. No.
LLG-Lab Standing Rest	PU Foam	Glides	510-780	1	6.288 956 1
LLG-Lab Standing Rest	PU Foam	Glides, Foot Ring	510-780	1	6.288 957 2

1



6.288 956

2



6.288 957

3 Roller Steps, WEDO-Step

Manufactured from recyclable UV resistant polypropylene. Mounted on 3 castors allowing complete mobility which retract when stool is in use, providing a secure platform. No tools required for assembling. TÜV and GS approved.

Colour	Int. diam. mm	Ext. diam. mm	Height mm	Max. load kg	PK	Cat. No.
Blue	290	440	430	150	1	9.700 400
Red	290	440	430	150	1	9.700 401

3



4 Folding Steps K20

Extra wide (31 x 23 cm) threads allow the user to stand comfortably without tiring, even over prolonged periods. With automatic safety catch. Ergonomic square tube bracket. Max. load up to 150 kg

Height*	Number of steps	Colour	PK	Cat. No.
46	2	white	1	9.704 403
70	3	white	1	9.704 404

* Height of top step (cm)

4



1

9.129 800

LLG-Universal indicator paper, rolls

For the determination of pH values. Plastic dispensing reel with 1 roll of 5 m.

Description	Range pH	PK	Cat. No.
Dispensing reel with 1 roll	1 - 11	1	9.129 800 1
Dispensing reel with 1 roll	1 - 14	1	9.129 802
Refill packs with 3 rolls	1 - 11	3	9.129 801
Refill packs with 3 rolls	1 - 14	3	9.129 803

2

2 LLG-Universal indicator paper, strips

For determination of pH value. Vial with snap lid of 100 pre-cut indicator paper strips.

Range pH	Package contents	PK	Cat. No.
1 - 14	100 strips per vial with snap lid	100	9.129 805

3

9.129 807

LLG-Indicator paper sticks

For pH determination. Box of 100 indicator paper sticks of 80 mm length.

Range pH	Package contents	PK	Cat. No.
0 - 14	50 sticks per pack	50	9.129 806
0 - 14	100 sticks per pack	100	9.129 807 3

4

4 5 LLG-Universal Indicator strips, in vial with snap lid "Premium"

Flip-top vial easy to open and close with one hand. The new LLG pH strips offer the utmost in convenience and ease of use in laboratory grade testing. With a single colour match, and a 12mm reagent pad, these universal pH strips (0.0-14.0) belong in every lab.

- pH measuring range: 0 - 14.0
- 12 mm matching area for quick matches,
- Flip-top vial stays closed when dropped, but is easy to open with one-hand.
- Vial keeps strips safe from the elements
- 1 pack (vial) of 100 strips

5

Range pH	Package contents	PK	Cat. No.
0 - 14	100 strips per vial with snap lid	100	9.129 808

1 2 pH tester LLG-pH Pen

Cost efficient pH tester, ideal for testing small amounts of liquid and in narrow vessels.

3-point calibration, ATC from 0 °C and 50 °C. Supplied with storage vessel, no dry-out of the electrode.

Specifications

Measuring range:	0.00 to 14.00 pH
Accuracy:	±0.1 pH
Dimensions with electrode (L x W x H):	210 x 36 x 20 mm
Dimensions electrode (diam. x L):	12 x 110 mm
Weight:	72 g
Battery:	2 x 3 V CR2032 button cell
Protection class:	IP 65
Warranty:	2 years

Type	PK	Cat. No.
LLG-pH Pen	1	6.263 690



3 LLG pH Meter 5

The LLG pH meter is a very easy to use pH/mV/°C handheld meter. The pH value and temperature can be stored directly on the SD card (Excel file) or transferred directly from the pH meter to a PC via the RS-232 interface.

- Combined, gel filled pH electrode with temperature sensor
- Automatic temperature compensation (ATC)
- Large, easy-to-read LCD display
- 3 point calibration
- 1m cable
- BNC connector

Please order batteries separately
 Optional: power cable, PC connection cable, PC software

Scope of supply: pH meter, pH electrode with temperature sensor, buffers pH4 and pH7, 4 GB SD-Memory card, transport case.

Specifications

Measuring range:	0 ... 14.00 pH
Resolution:	0.01 pH
Accuracy:	±(0.02 pH + 2d)
Ambient conditions:	0 ... 50 °C, max. 85 % r.F.
Temperature range electrode:	0 to 60 °C
Dimensions (L x W x H):	177 x 68 x 45 mm
Weight:	490 g
Power supply:	6 x 1.5 V AA batteries/9 V mains adapter (optional)
Memory:	1 ... 16 GB depending on SD card
Protection class:	IP51
Warranty:	3 years (1 year on the electrode)

Description	PK	Cat. No.
LLG-pH Meter 5, set with electrode, temperature sensor, SD card and case	1	6.263 691
Electrode + temp. sensor for LLG-pH meter 5	1	6.263 692
SD card 4GB for LLG-pH meter 5	1	6.263 693
Case for LLG-pH Meter 5	1	6.263 694
Power cable for LLG-pH Meter 5	1	6.263 695
Connecting cable PC for LLG-pH Meter 5	1	6.263 696
Software for LLG-pH Meter 5	1	6.263 697



4 LLG-Electrode stand for 3 electrodes

With cable duct. For three electrodes, 3 opening with diam. 16 mm. Additional opening for temperature sensor. Three joints for high flexibility and adjustment options.

Base plate:	105 x 125 mm
Base plate weight:	0.7 kg
Arm weight:	0.1 kg
Max. arm height:	320 mm

Type	PK	Cat. No.
LLG-Electrode stand	1	6.286 248



1 Compact balances Type EMB

Economically priced, battery-operated models. Large LCD readout with 15 mm high digits. "Weigh-in" function simplifies mixing. Supplied with 9V block or 2 x 1.5V AA batteries (Types EMB 2200-0 and EMB 5.2K2). With d.c. power connection socket (accessory mains adapter Cat. No. 6.270 080 available at extra cost). Auto-off function activates after 3 minutes without use for saving battery power.

Dimensions (W x D x H): 170 x 240 x 39 mm

EMB 100-3/EMB1000-2: 170 x 240 x 54 mm

Net weight: approx. 750 g

Type	Plate diam. mm	Capacity g	Readability g	Reproducibility g	Linearity ± g	PK	Cat. No.
EMB 100-3	82	100	0.001	0.001	0.003	1	6.238 426
EMB 200-2	105	200	0.01	0.01	0.02	1	9.901 320
EMB 600-2	105	600	0.01	0.01	0.03	1	9.901 321
EMB 1000-2	150	1000	0.01	0.01	0.03	1	6.235 728
EMB 500-1	150	500	0.1	0.1	0.2	1	9.901 322
EMB 1200-1	150	1200	0.1	0.1	0.3	1	9.901 323
EMB 5.2K1	150	5200	1.0	1.0	3.0	1	9.901 324
EMB 5.2 K 5	150	5200	5.0	5.0	10.0	1	9.901 372
EMB 2200-0	150	2200	1.0	1.0	2.0	1	9.901 371

1



2 3 Precision balance EWJ

Verifiable entry level model in the upper laboratory class with EC type approval

- Concept of easy use: All primary functions have their own key on the keypad
- Automatic internal adjustment time-controlled every 4 hours. Guarantees high degree of accuracy and makes the location irrelevant
- Ideal for mobile applications which require verification, such as ambulatory gold and jewellery purchasing
- Compact size, practical for small spaces
- Capacity display: A bar lights up to show how much of the weighing range is still available
- Draft shield with removable cover and opening for using a pipette standard on all models 80mm and 135mm plate diameter.
Weighing space (W x D x H): 145 x 160 x 80 mm
- RS-232 and USB interfaces for transferring weighing data to the PC, printer, USB sticks etc.

Type	Plate dimensions mm	Weighing range g	Readability g	Linearity ± g	PK	Cat. No.
EWJ 300-3	Ø 80	300	0.001	0.005	1	9.900 938
EWJ 600-2M*	Ø 135	600	0.01	0.03	1	9.900 939
EWJ 6000-1M*	155 x 145	6000	0.1	0.2	1	9.900 940

*calibratable

2



3



1 LLG weighing scoops, porcelain

Length mm	PK	Cat. No.
37	1	9.115 350
53	1	6.241 255
64	1	9.115 351



2 Weighing scoops, stainless steel 18/10

Capacity ml	PK	Cat. No.
3	1	6.238 169
6	1	6.238 170
10	1	6.238 171



3 Weighing scoops, glass

Made of high quality Borosilicate glass 3.3. Ideal for powders or granules which are dispensed via the tubular stem.

Capacity ml	PK	Cat. No.
3	1	9.301 066
6	1	9.301 067
10	1	9.301 068



4 Weighing boat parchment paper, Kjeldahl 609, nitrogen-free

Ideal for weighing and transporting all types of sample. Especially for determination of nitrogen according to Kjeldahl (e.g. determination of total protein content in foodstuff). Made of nitrogen-free parchment paper. Can be dropped into the Kjeldahl flask and be dissolved together with the sample.

Width mm	Length mm	Height mm	PK	Cat. No.
10	55	10	100	9.069 011



5 LLG-Weighing paper

Smooth surface. 45 g/m² paper. Block of 500 sheets.

Dimensions (D x W) mm	PK	Cat. No.
76 x 76	500	6.272 246
102 x 102	500	6.272 247
152 x 152	500	6.272 248



6 LLG-Weighing bottles with NS lid, Borosilicate glass 3.3

With writing area.
Available in tall or low shape.

Form	Capacity ml	Diam. mm	Height mm	NS	PK	Cat. No.
low	3	25	25	19/12	1	9.300 151
low	10	35	30	29/12	1	9.300 152
low	11	40	25	34.5/12	1	9.300 150
low	20	50	30	45/12	1	9.300 153
low	29	60	30	50/12	1	9.300 154
low	60	80	30	80/12	1	9.300 155
tall	9	25	40	19/12	1	9.300 160
tall	19	30	50	24/12	1	9.300 161
tall	42	35	70	29/12	1	9.300 162
tall	66	40	80	34.5/12	1	9.300 163
tall	105	50	80	45/12	1	9.300 164



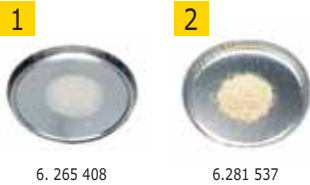

LLG-Sample dishes, Aluminium

High quality aluminium sample dishes, for moisture determination.

Description	Diam. mm	Height mm	PK	Cat. No.
Sample dishes	90	7	80	6.282 670
Sample dishes	100	7	80	6.265 408 1
Sample dishes with rim	100	7	80	6.281 537 2



3 4 LLG-Weighing dishes, aluminium

Made from oil-free, lightweight aluminium. With a flanged, crimped wall for rigidity. Finger-tab handle can be etched for identification prior to weighing.

Ø mm	Height mm	PK	Cat. No.
43	12	100	6.238 138
57	14	100	6.238 139
70	16	100	6.238 140
101 *	8	50	6.236 854

* without Finger-tab handle



5 LLG-Weighing boats, antistatic, PS

Biologically inert and resistant to dilute and weak acids, aqueous solutions, alcohols, and bases. Temperature range -10 to +70 °C. Can be used with microwave moisture analysers. Features a diamond shape that easily flexes for accurate pouring and a wide, flat bottom to resist tipping.

Capacity ml	Colour	Dimensions mm	PK	Cat. No.
5	white	55 x 35 x 6	1000	9.900 788
30	white	85 x 65 x 14	500	9.950 194
100	white	125 x 100 x 19	250	9.950 195
5	black	55 x 35 x 6	1000	9.900 801
30	black	85 x 65 x 14	500	9.950 196
100	black	125 x 100 x 19	250	9.950 197



6 LLG-Hexagonal weighing boats, antistatic, PS

Biologically inert and resistant to dilute and weak acids, aqueous solutions, alcohols, and bases. Temperature range -10 to +70 °C. Can be used with microwave moisture analysers. Bend flexible boats at points to form pour spouts. Flat bottoms to resist tipping. Sloping sides provide accurate transfer.

Colour	Size	Dimensions mm	PK	Cat. No.
white	Small	38 x 25 x 9	500	9.900 893
white	Medium	64 x 51 x 19	500	9.900 894
white	Large	102 x 76 x 22	500	9.900 895
white	X-Large	127 x 89 x 31	500	9.900 896



7 LLG-Square weighing boats, antistatic, PS

Biologically inert and resistant to dilute and weak acids, aqueous solutions, alcohols, and bases. Temperature range -10 to +70 °C. Can be used with microwave moisture analysers. Boats are shallow with a wide, flat bottom to resist tipping. Rounded corners simplify transfer.

Capacity ml	Colour	Dimensions (W x D x H) mm	PK	Cat. No.
7	White	44 x 44 x 8	1000	9.900 785
100	White	80 x 80 x 24	1000	9.900 786
250	White	140 x 140 x 22	1000	9.900 787
7	Black	44 x 44 x 8	1000	9.900 789
100	Black	80 x 80 x 24	1000	9.900 791
250	Black	140 x 140 x 22	1000	9.900 800

LLG-General purpose thermometers *economy*

Solid stem, with loop, capillary yellow enameled, graduation resistant against acids and alkalis.
Red filling or environmentally friendly blue filling.

Charge colour	Diam. mm	Length mm	Immersion depth	Measuring range °C	Graduations °C	PK	Cat. No.
red	6	300	total	-10 ... +50	1	1	9.237 010
red	6	300	total	-10 ... +100	1	1	9.237 011
red	6	300	total	-10 ... +150	1	1	9.237 012 ¹
red	6	300	total	-10 ... +200	1	1	9.237 013
red	6	300	total	-10 ... +250	1	1	9.237 014
blue	7-8	300	76 mm	-10 ... +110	1	1	9.237 015
blue	7-8	300	76 mm	-10 ... +110	0,5	1	9.237 016 ²
blue	7-8	300	76 mm	-10 ... +150	1	1	9.237 017
blue	7-8	300	76 mm	-10 ... +250	1	1	9.237 018
blue	7-8	300	76 mm	-10 ... +360	2	1	9.237 019



3 LLG-General purpose thermometer, red filling

Graduation resistant against acids and alkalis.
Breakage protected versions with FEP-coating available on request.



Diam. mm	Length mm	Immersion depth	Measuring range °C	Graduations °C	Capillary	PK	Cat. No.
6 ±1	300	total	-35 ... +50	1	white enameled, round	1	9.236 720
6 ±1	300	total	-20 ... +110	1	white enameled, round	1	6.206 594
6 ±1	300	total	-20 ... +150	1	white enameled, round	1	9.236 723
6 ±1	300	76 mm	-20 ... +150	1	white enameled, round	1	9.236 731
6 ±1	260	total	-10 ... +110	1	yellow enameled, round	1	9.236 721
6 ±1	270	76 mm	-10 ... +110	1	yellow enameled, round	1	9.236 727
6 ±1	260	total	-10 ... +150	1	yellow enameled, round	1	9.236 722
6 ±1	300	total	-10 ... +200	1	yellow enameled, round	1	9.236 724
6 ±1	300	total	-10 ... +200	1	white enameled, round	1	9.236 725
6 ±1	300	76mm	-10 ... +200	1	white enameled, round	1	9.236 730
6 ±1	300	total	-10 ... +250	1	yellow enameled, round	1	9.236 726

4 LLG- General-purpose thermometers, red filling

Enclosed-scale type, with eyelet. With uncoated, prismatic measuring capillary.
Red spirit filling (except 9.235 265: blue).

Diam. mm	Length mm	Immersion depth	Measuring range °C	Graduations °C	PK	Cat. No.
7 - 8	200	total	-10/0 ... +50	1	1	9.235 245
7 - 8	260	total	-10/0 ... +100	1	1	9.235 250
7 - 8	260	total	-10/0 ... +150	1	1	9.235 255
7 - 8	300	total	-10/0 ... +200*	1	1	9.235 260
7 - 8	300	total	-10/0 ... +250*	1	1	9.235 265

* Note: With these types the colour can fade after extended periods of use at higher temperatures.



5 LLG- General-purpose thermometers, green filling

Glass, solid stem, with loop, white backed.
Environmentally friendly thermometer, with biodegradable, green spirit filling.

Diam. mm	Length mm	Immersion depth mm	Measuring range °C	Graduations °C	PK	Cat. No.
6-7	300	76	-10/0 ... +110	1.0	1	9.235 275
6-7	300	76	-10/0 ... +110	0.5	1	9.235 276
6-7	300	76	-10/0 ... +150	1.0	1	9.235 277
6-7	300	76	-10 ... +250	2.0	1	9.235 278
6-7	300	76	-10 ... +360	2.0	1	9.235 279

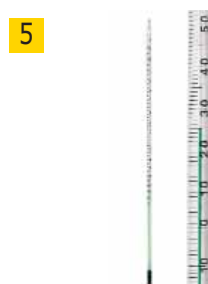

Thermometers/Laboratory thermometers

1

1 LLG-Precision thermometer, calibratable, red filling

Capillary: yellow enameled, round. Optional available with official calibration certificate, works certificate or DKD-calibration certificate. Please specify with order.

Breakage protected versions with FEP-coating available on request.

Diam.	Length	Measuring range	Graduations	PK	Cat. No.
mm	mm	°C	°C		
6 ±1	305	-10 ... +100	1.0	1	9.236 783
6 ±1	305	-10 ... +150	1.0	1	9.236 784
6 ±1	270	-10 ... +100	0.5	1	9.236 785
6 ±1	350	-10 ... +150	0.5	1	9.236 786
6 ±1	420	-0 ... +50	0.1	1	9.236 787

2

2 LLG-Low temperature thermometers, -100 to +30 °C

Suitable for official calibration. Enclosed scale type, 8 to 9 mm diameter, with translucent glass scale and Richter seal. Prismatic, uncoated measuring capillary. Red toluene filled. Graduated every 1 °C.

Length	Measuring range	PK	Cat. No.
mm	°C		
300	-50 ... +50	1	9.235 705
300	-80 ... +30	1	9.235 708
300	-100 ... +30	1	9.235 710

3

3 LLG-Exact-Temp thermometers

For monitoring critical temperature conditions in deep freezes, refrigerators, cold rooms, blood bank refrigerators, incubators and warming chambers.

- thermometer certifiable to National Standards
- supplied with works test certificate
- thermometer stem safely encapsulated in PTFE
- each thermometer is mounted in a square-shaped shatter-proof plastic bottle filled with a liquid to ensure accurate readings despite the opening and closing of instrument doors.
- each thermometer has an individual serial number.

LLG-Exact-Temp Standard thermometers, red spirit-filled

Measuring range	Length	Grad.	Bottle filling	PK	Cat. No.
°C	mm	°C			
-90 ... +20	145	1.0	Sand	1	9.235 663
-30 ... 0	125	0.5	Ethylene Glycol	1	9.235 664
-5 ... +15	125	0.5	Ethylene Glycol	1	9.235 666
+18 ... +50	135	0.5	Ethylene Glycol	1	9.235 667
+20 ... +130	135	1.0	Vermiculite	1	9.235 668

LLG-Exact-Temp precision thermometers, blue spirit-filled

Measuring range	Length	Grad.	Bottle filling	PK	Cat. No.
°C	mm	°C			
-2 ... +10	180	0.1	Ethylene Glycol	1	9.235 676
+15 ... +30	180	0.1	Ethylene Glycol	1	9.235 678
+25 ... +45	190	0.1	Ethylene Glycol	1	9.235 679

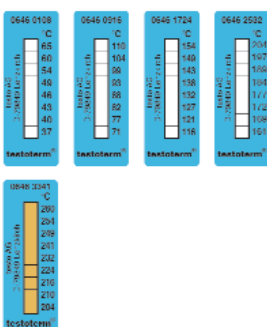
4

4 8-step irreversible temperature strips testoterm®

Strips for 8 temperatures. 5 types cover the measuring range +37 to +280 °C, each strip displays 8 different temperatures. Each strip measures 50 x 18 mm.

Measuring range	PK	Cat. No.
°C		
+37 ... +65	10	9.246 002
+71 ... +110	10	9.246 003
+116 ... +154	10	9.246 004
+161 ... +204	10	9.246 005
+204 ... +260	10	9.246 006

1 Refrigerator thermometer

Plastic, with loop or hook clip mountings. Measuring range -40 to +40 °C. Graduated every 1 °C. Dimensions (L x dia.) 185 x 20 mm.

Type	PK	Cat. No.
Refrigerator thermometer	1	9.242 340



2 LLG Min/Max Thermometer with outdoor sensor

Digital thermometer with outdoor sensor.

- Two-tier LCD display
- Measuring temperature range -50 °C to +70 °C
- Display resolution 0.1 °C
- Accuracy ±1 °C
- Dimensions 110 x 70 x 20 mm
- Display size 40 x 30 mm
- AAA 1.5V battery included
- Length of the cable 190 cm

Type	PK	Cat. No.
LLG Min/Max Thermometer with outdoor sensor	1	9.243 165



3 LLG-Digital pocket thermometer Type 12050

Measuring range -50 to +150 °C, accuracy ±1 °C. Probe made of stainless steel, 120 x 3.5 mm, with protective plastic sleeve and clip, with battery 1 x 1.5 V (LR44). Overall dimensions (L x W): 75 x 20 mm.

Type	PK	Cat. No.
LLG-Digital pocket thermometer Type 12050	1	9.236 706



4 LLG-Digital pocket thermometer Type 12060

Measuring range -50 to +150 °C, accuracy ±1 °C. With hold function. Probe made of stainless steel, 125 x 3.5 mm, with protective plastic sleeve and clip, with battery 1 x 1.5 V (LR44). Dimensions (L x W): 60 x 20 mm.

Type	PK	Cat. No.
LLG-Digital pocket thermometer Type 12060	1	9.236 701



5 LLG-Digital pocket thermometer Type 12070

Measuring range -50 to +300 °C, accuracy ±1 °C until 150°C, above ±2°C. With hold function. Probe 200 x 3.5 mm with tip made of stainless steel, with adjustable protective plastic sleeve and clip, with battery 1 x 1.5 V (LR44). Dimensions (L x W): 78 x 25 mm.

Type	PK	Cat. No.
LLG-Digital pocket thermometer Type 12070	1	9.236 702



6 LLG-Digital pocket thermometer Type 12080

Waterproof. Measuring range -50 to +300 °C/-58 to +572 °F, accuracy ±1°C until 150°C, above ±2 °C. With hold function and Max/Min function. Probe made of stainless steel, 85 x 3.5 mm, with protective plastic sleeve, with battery 1 x 1.5 V (LR44). Overall dimensions (L x W): 195 x 50 mm.

Type	PK	Cat. No.
LLG-Digital pocket thermometer Type 12080	1	9.236 703



1

1 LLG-Digital pocket thermometer Type 12090

Waterproof. Measuring range -50 to +150 °C/-58 to +302 °F, accuracy ±1 °C. With hold function. Probe made of stainless steel, 85 x 3.5mm, with protective plastic sleeve, with battery 1 x 1.5V (LR44). Overall dimensions (L x W): 185 x 30 mm.

Type	PK	Cat. No.
LLG-Digital pocket thermometer Type 12090	1	9.236 707

2

2 Thermometer Pocket-Digitemp

Waterproof instrument in plastic housing (food-grade). Low budget, durable instrument for measuring temperature in air, gas, liquid and ductile substances (acc. to EN 13485). **Range of applications:** Food (HACCP), industry and agriculture. **Features:** waterproof, 1-second measuring frequency, Max-Min-Hold function, °C/°F-selectable.

Sensor:	NTC
Measuring range:	-40°C to +200 °C
Resolution:	0.1 °C
Accuracy:	±0.8 °C (at 0 °C to 100 °C) others 1.5 °C
Dimensions:	202 x 20 x 16 mm (long version) 150 x 20 x 16 mm (short version)
Probe dimensions:	126 x 3.5 mm (long version) 75 x 3.5 mm (short version)
Weight:	40 g

Type	PK	Cat. No.
short version	1	9.851 028
long version	1	9.851 029

3

3 Infra-red thermometer ScanTemp 385

With IR thermometers you can measure surface temperature. A short response time and non-contact measurement are key advantages. ideal for monitoring applications such as:

- moving parts (running paper webs...)
- registering the surface temperature of gears and motors
- checking live electrical parts (components, transformers...)
- newly coated or painted parts
- food and corrosive substances

Specifications	
Temperature range:	-35 °C to +365 °C
Precision:	±2 % or 2 °C, the higher value counts
Response time:	< 1 sec
Spectral sensitivity:	6 to 14 µm
Operating temperature:	0 to 50 °C
Optical resolution:	12:1
Laser:	Spot laser
Dimensions (L x W x H):	147.9 x 112.6 x 41.4 mm
Weight:	150 g (incl. packaging)
Battery:	2 x 1.5V AAA Batteries

Type	PK	Cat. No.
ScanTemp 385	1	9.851 996

1 Data Logger LOG32T

The LOG32T is perfectly designed for product transportation or storage applications. Ambient conditions in power plants.

- Memory size: 60 000 measurements
- Usable without software (default settings) (15-minute-interval, without alarm settings)
- Optional free of charge software download for alarm setting and free adjustable recording interval (30 sec to 24 h)
- Automatic PDF creation
- Battery lifetime > 3 years (recording interval >15 minutes)
- Status and Alarm-LEDs, acoustic signal
- Includes wall mount
- HACCP (EN12830) conform
- IP65 watertight



Specifications

Measuring range:	-40 ... +70 °C
Accuracy:	±0.5°C (-10 ... +40 °C), otherwise ±1.0 °C
Resolution:	0.1 °C
Memory:	60 000 measurements
Interface:	USB (integr.)
Housing:	ABS
Dimensions (L x W x H):	100 x 19 x 19 mm
Weight:	70g
Battery:	1 x 3.6 Volt Lithium ½ AA

Type	PK	Cat. No.
LOG32T	1	9.726 431

2 LLG-Timer with Triple Alarms, 1-channel

Choice of vibration, sound and/or light alarms makes this timer perfect for high noise locations.

- Vibration, light and loud buzzer sound alarms can function at one time, or be independently turned off
- Maximum run time: 19 hours: 59 minutes/99 minutes: 59 seconds;
- Timer accuracy: ±7 seconds/day
- Count direction: up/down; displays elapsed time after countdown
- Last time set memory
- Key press confirmation feature gives an audible indication of data entry
- Lay it flat on a bench, use the flip-open stand for a vertical view, carry it on a lab coat with the convenient pocket clip, or use the magnetic back for metal surface attachment
- Requires two AAA batteries (included)
- Individually tested, inspected, and calibrated using NIST
- Includes Certificate of Calibration with unique report number, stated corrections and standard used for the calibration, and multi-language instructions (English, French, German, Italian, Portuguese and Spanish)
- CE mark, RoHS compliant



Dimensions (W x D x H): 45 x 75 x 20 mm (without clip portion)

Type	PK	Cat. No.
LLG Timer with Triple Alarms, 1-channel	1	6.266 707

3 LLG-Timer with White Board, 4 channel

This four channel timer has a built in white board that helps keep track of time and other critical information.

- Audible alarm for each channel
- Built in white board and dry erase marker with eraser tip (included) helps keep track of crucial information
- Programs: hours/minutes; Displays: hours/minutes/seconds
- Maximum run time: 23 hours: 59 minutes
- Timer accuracy: ±5 seconds/day
- Count direction: up/down; displays elapsed time after countdown
- Last time set memory
- Key press confirmation feature gives an audible indication of data entry
- Lay flat on a bench, use the flip-open stand for a vertical view, or use the magnetic back for metal surface attachment
- Requires two AAA batteries (included)
- Individually tested, inspected, and calibrated using NIST
- Includes Certificate of Calibration with unique report number, stated corrections and standard used for the calibration, and multi-language instructions (English, French, German, Italian, Portuguese and Spanish)
- CE mark, RoHS compliant



Dimensions (W x D x H): 114.3 x 25.4 x 88.9 mm

Type	PK	Cat. No.
LLG Timer with White Board, 4 channel	1	6.266 706

Timing/Timers

1

1 LLG-Timer Cube

With 4 pre-set countdown times. Place the cube with the desired time facing up and the counting down starts immediately.

- Pulsing LED when timer is counting
- Automatically rotating flip display shows the remaining time
- After expiration, the elapsed time is displayed until the alarm ends
- Optional pre-alarm shortly before time expires

Dimensions (D x W x H): 60 x 60 x 60 mm
 Weight: 58 g
 Power supply: 2 x 1.5 V (not incl.)

Description	Colour	PK	Cat. No.
5-15-30-60 minutes	orange	1	6.291 217

2

2 LLG-Short period timer with alarm

Timer and stopwatch at the same time, from/up to 99 min. and 59 sec.

Easy-to-use, with large display and alarm function.

With magnet for easy fixing.

Battery LR 44 inclusive.

Dimensions (Ø x H): 54 x 16.5 mm
 Weight: approx. 40 g

Type	PK	Cat. No.
LLG-Short period timer with alarm	1	9.260 150

3

3 Interval timer with alarm

Benchtop mechanical timer. Suitable for standing, hanging and in addition on the back of two magnets, which allows the fitting of metal parts. Casing and rotary setting knob are white, the dial is black.

Running time max. 60 mins. Metal movement.

Dimensions (W x H x D): 70 x 70 x 40 mm

Type	PK	Cat. No.
Interval timer with alarm	1	9.260 020

4

4 Short period timer

Electronic timer and stopwatch with large display and 10-key setting. Counts up or down from 10 hours to 1 second.

With pocket clip, bench stand, magnetic attachment and AAA 1.5V battery.

Dimensions (W x H x D): 60 x 70 x 25 mm
 Weight: 95g

Type	PK	Cat. No.
Timer II	1	9.851 027

5

5 Laboratory short period timer, compact

Compact. Countdown/Countup. Digital reading, with alarm and repeat function. 12 hr. clock function.

Countdown and countup display: 23 hrs, 59 mins, 59 secs. Battery SR 44 inclusive.

Dimensions (W x H x D): 64 x 60 x 16 mm
 Weight: 40 g

Type	PK	Cat. No.
Compact	1	9.262 071

6

6 Dual short period timer TR 118 OS

- Large, 6 digit, LCD readout
- 2 separate timers in one instrument
- Countdown/countup 99 hrs. 59 mins. 59 secs.
- Clock function switch
- Audible alarm sounds when 'zero' reached
- With pocket clip/bench stand and magnet
- Supplied with AAA 1.5V battery

Dimensions (W x H x D): 73 x 66 x 18 mm
 Weight: 63 g

Type	PK	Cat. No.
TR 118 OS	1	9.260 186

1 2 Melting point meters LLG-uniMELT 2 und 3

Ideal for determination of the melting point of powders up to 360 °C and substances that do not have a clear transparent melting point. Both devices have a USB interface that permits printing a measuring protocol or generating a PDF file that corresponds to the demands of a contemporary QMS documentation.

Properties for both models:

- Digital temperature control on large display
- Selectable user language German or English
- Sample can be monitored through a magnifying glass with integrated light
- For capillaries with 1.4mm outer diameter
- Text display of error messages
- Keyboard covered with foil for easy cleaning
- USB port
- Height adjustable table stand
- Operating instructions in German, English, Spanish, French and Russian.
- Brief instructions right at the device
- Up to 3 measurements could be stored and printed as protocol at the same time
- The protocol contains all the relevant data of the probe, the measurement and the device

LLG-uniMELT 2: For visual, semi-automatic measurement with magnifying glass. In this model, the melting point is determined visually (max. and then saved by pushing the "Save" key. The value can be printed or stored by pushing the memory button and read on the display until the device is switched off or a new measurement is performed.

LLG-uniMELT 3: For visual measurement with magnifying glass or automatic measurement. Either fully automatic or visual measurements, 1 sample each. If you chose automatic measurement, additionally a transparency progression is printed. For visual measurement, only the melting point determined by you will be printed. The value can be stored by pushing the memory button and read on the display until the device is switched off or a new measurement is performed.

Scope of delivery: Melting point meter, table stand, 100 melting point tubes, protection hood, USB-cable, Software. Refill pack melting point tubes for LLG-uniMELT please order Cat. No. 9.208 131.

Specifications

Measuring range:	25.0 °C to 360.0 °C
Resolution:	0.1 °C
Accuracy:	±0.4 °C
Reproducibility:	±0.3 °C
Heating rate at fast heating:	to 100 °C approx. 2 min; to 300 °C approx. 7 min
Heating rate when measuring:	1 °C/min
Magnifying glass:	20 dpt/5 x
Lighting:	2 x LED
Dimensions housing (WxDxH):	320 x 6.5 x 260 mm
Dimension table stand (WxH):	85 x 55 mm
Dimensions capillaries:	1.45 mm x 80 mm
Protection class:	IP 20
Weight:	4.0kg
Power supply:	88-264 V, 50Hz



Type	Description	PK	Cat. No.
LLG-uniMELT 2	Visual measuring / magnifier	1	6.263 685
LLG-uniMELT 3	Visual or automatical measuring with printer	1	6.263 686

3 Melting point tubes

Capillary tubes for melting point analysis. Clear glass, different diameters and lengths. Special remarks are available. Other sizes on request.

Type	Ext. diam. mm	Int. diam. mm	Length mm	Material	PK	Cat. No.
Sealed one end	1.00	0.80	80	Duran®	100	9.208 081
Open both ends	1.00	0.80	80	Duran®	100	9.208 080
Sealed one end	1.00	0.80	100	Duran®	100	9.208 101
Open both ends	1.00	0.80	100	Duran®	100	9.208 100
Open both ends	1.35	0.95	120	Soda glass	250	6.229 232
Sealed one end	1.45	1.00	80	Soda glass	100	9.208 131
Sealed one end	1.55	1.15	75	Soda glass	100	9.208 076



IP Protection classes

IP	Characteristic 1 for special protection	IP	Characteristic 2 for waterproofing
0	No special protection	0	No waterproofing
1	Protection from solid objects greater than 50 mm in diameter	1	Protection from dripping water
2	Protection from object greater than 12 mm in diameter	2	Protection from vertically dripping water (tilted up to 15°)
3	Protection from object greater than 2.5 mm in diameter	3	Protection from sprayed water (tilted up to 60°)
4	Protection from object greater than 1 mm in diameter	4	Protection from splashed water
5	Complete protection against contact, Protection against dust deposit	5	Protection from water projected from a nozzle
6	Complete protection against contact, Protection from infiltration of dust	6	Protection against heavy seas or powerful jets of water.
		7	Protection against immersion
		8	Protection against complete, continuous submersion in water.
		9	Protection against the ingress of water from all directions even under greatly high pressure on the housing. (High-pressure/steam cleaner, 80-100 bar)

IP 64

IP 64 { 6: Complete protection against contact, Protection from infiltration of dust
4: Protection from splashed water



1 Magnetic stirrer LLG-uniSTIRRER 2

Compact and cost-efficient magnetic stirrer without heating for volumes up to 1000 ml. Adjustable speed from 0 to 2000 rpm. Plate diameter 120 mm. Body made of ABS.

Support rod, aluminium (Cat. No. 6.263 435) available as an optional accessory.

Specifications

Stirring quantity (H:O):	1000 ml
Speed range:	0 to 2000 rpm
Permissible ambient temperature:	0 to 50 °C
Permissible relative moisture:	85 %
Material:	ABS case
Dimensions (W x D x H):	150 x 135 x 53 mm
Weight:	0.5 kg
Power supply:	100 - 230 V, 50/60 Hz
Protection class:	IP 21
Warranty:	3 years

Type	PK	Cat. No.
LLG-uniSTIRRER 2 with EU-plug	1	6.263 430
LLG-uniSTIRRER 2 with UK-plug	1	6.263 431
Support rod, 25 cm, aluminium	1	6.263 435



1 Magnetic stirrer LLG-uniSTIRRER 1 **1**

An **ultra-flat** inductive magnetic stirrer without heating with timer. The modern magnet coil technology consists only of non-moving parts and therefore guarantees a wear-free drive.

For a better mixing of samples it is possible to change the direction of rotation every 30 seconds.

- **Timer** (1 min to 99 min, infinitely)
- 100 % wear- and maintenance-free inductive drive
- LED-display for an exact adjustment of the rotation speed
- Digital regulated rotation speed
- Alteration of the stirring direction
- Protection class IP 65
- Stainless steel surface

Delivery includes: magnetic stirrer, power cable, adapters for UK and universal plug.



Specifications

Stirring quantity (H ₂ O):	800 ml
Speed range:	15 to 1500 rpm
Permissible ambient temperature:	5 to 40 °C
Magnetic bar:	max. 25 mm
Display:	LED
Heating plate:	94 mm diam./Stainless steel
Dimensions (W x D x H):	110 x 155 x 12 mm
Weight:	0.5 kg
Power supply:	100 - 230 V, 50/60 Hz
Protection class:	IP 65
Warranty:	3 years

Type	PK	Cat. No.
LLG-uniSTIRRER 1	1	6.263 420

2 4-Position-Magnetic Stirrer LLG-uniSTIRRER 1/M4 **2**

An **Ultra-flat** inductive magnetic stirrer without heating with timer. The modern magnet coil technology consists only of non-moving parts and therefore guarantees a wear-free drive.

For a better mixing of samples it is possible to change the direction of rotation every 30 seconds.

- Max. stirring quantity per stirring position 400 ml
- **Timer** (1 to 99 min, infinitely)
- 100 % wear- and maintenance-free inductive drive
- LED-display for an exact adjustment of the rotation speed
- Digital regulated rotation speed
- Alteration of the stirring direction
- Protection class IP 65
- Stainless steel surface

Specifications

Stirring positions:	4
Distance between stirring positions:	95 mm
Max. Stirring quantity (H ₂ O):	4 x 400 ml = 1600 ml
Speed range:	15 to 1200 rpm
Permissible ambient temperature:	5 to 40 °C
Magnetic bar:	max. 25 mm
Display:	LED
Heating plate (W x D):	122 x 385 mm
Dimensions (W x D x H):	126 x 457 x 13.5 mm
Weight:	1.9 kg
Power supply:	100 - 240 V, 50/60 Hz
Protection class:	IP 65
Warranty:	3 years



Type	PK	Cat. No.
LLG-uniSTIRRER 1/M4 with EU-plug	1	6.263 425
LLG-uniSTIRRER 1/M4 with-UK plug	1	6.263 426

1

1 2 Magnetic stirrer with heating LLG-uniSTIRRER 3, complete set

Universal magnetic stirrer with all essential functions and equipment features. A LED display to control all parameters, an integrated temperature control as well as an enclosed design (IP 42) are integrated features. The included PT1000 sensor ensures an exact temperature control. A stand rod with a sensor holder is supplied with this instrument. The integrated **HOT-sign** warns the user of a hot plate even if the device is switched off.

- LED display to set the exact rotation speed and the temperature
- Digital controlled rotation speed and temperature
- 'HOT' warning sign, even if the device is switched off
- **Delivered as complete set:** magnetic stirrer, sensor PT1000, stand rod and sensor holder
- Integrated temperature control

Delivery includes: Magnetic stirrer with PT1000 probe, rod and holder

Specifications

Stirring quantity (H ₂ O):	3000 ml
Speed range:	100 to 1500 rpm
Setting accuracy:	±10 rpm
Magnetic bar:	max. 50 mm
Display:	LED
Heating plate:	135 mm diam./Stainless steel
Permissible ambient temperature:	5 to 40 °C
Temperature range:	RT to 280 °C
Setting accuracy:	±1 °C
Control accuracy:	±2 °C
Heat output:	500 W
Safety temperature:	320 °C
Dimensions (W x D x H):	155 x 215 x 100 mm
Weight:	1.5 kg
Power supply:	200 - 240 V, 50/60 Hz
Protection class:	IP 42
Warranty:	3 years

2

Type	PK	Cat. No.
LLG-uniSTIRRER 3 with EU-plug	1	6.263 410
LLG-uniSTIRRER 3 with UK-plug	1	6.263 411
Stand and sensor holder for LLG-uniSTIRRER 3	1	6.263 416

3

3 LLG-Magnetic stirring bars, cylindrical, PTFE, *eco pack*

Circular, smooth and PTFE-coated. Packaging size: 10 pieces

Diam. mm	Length mm	PK	Cat. No.
6	10	10	9.198 910
3	12	10	9.198 766
6	15	10	9.198 919
6	20	10	9.198 920
6	25	10	9.198 925
8	25	10	9.198 767
6	30	10	9.198 930
6	35	10	9.198 935
8	40	10	9.198 940
8	45	10	9.198 945
8	50	10	9.198 950
9	60	10	9.198 960
9	70	10	9.198 970
9	80	10	9.198 980

1 2 Magnetic stirrer with heating LLG-uniSTIRRER 5, complete package

Universal magnetic stirrer with an outstanding price-performance ratio. Safety features include a **"hot" warning display** and a stirring function that continues to run until the plate temperature is below 50 °C, even when the device is switched off. A digital timer enables unattended operation and can be set from 1 min to 99 h 59 min. When the set time has elapsed, the unit stops automatically. An integrated control function offers precise control of the heated fluid temperature via a remote PT1000 temperature probe. The device is equipped with a Ø 135 mm stainless steel plate with glass ceramic, suitable for the LLG-Universal reaction block systems.

- Latest generation magnetic stirrer/hotplate
- Maintenance-free, brushless DC motor
- **Timer** (1 min to 99 h 59 min)
- Digital control and **backlit display**
- Stirrer and display can be controlled remotely via an RS232 interface
- Hot surface indicator
- Stainless steel plate with glass ceramic
- Sturdy metal housing
- Powerful stirring
- Connection for PT1000, integrated control function

Delivery includes: Magnetic stirrer with PT1000 probe, rod and holder

Specifications

Stirring quantity (H ₂ O):	20 l
Speed range:	100 to 1500 rpm
Accuracy:	±1 rpm
Magnetic bar:	80 mm
Display:	LCD
Heating plate:	diam. 135 mm/ stainless steel plate with glass ceramic
Permissible ambient temperature:	5 to 40 °C
Temperature range:	ambient to 340 °C
Setting accuracy:	±0.1 °C
Control accuracy:	±0.2 °C
Heat output:	550 W
Safety temperature:	100 to 360 °C
Dimensions (W x D x H):	160 x 285 x 85 mm
Weight:	2.8 kg
Power supply:	200 - 240 V, 50/60 Hz
Protection class:	IP 42
Warranty:	3 years

Type	PK	Cat. No.
LLG-uniSTIRRER 5 with EU-plug	1	6.263 440
LLG-uniSTIRRER 5 with UK-plug	1	6.263 441
Silicone Protective cover for LLG-uniSTIRRER 5	1	6.263 445

1



2



3 LLG-Magnetic Stirring Bar Retrievers, PTFE

PTFE-encapsulated stirring bar retriever with strong permanent magnet (Alnico 5), universal chemical resistance. For the removal of stirring bars from aggressive liquids, prevents loss of stirring bars. Lower end diameter 10mm.

3



Diam. mm	Length mm	PK	Cat. No.
8	150	1	9.197 717
8	250	1	9.197 725
8	300	1	4.008 501
8	350	1	9.197 735

1 2 Magnetic stirrer with heating LLG-uniSTIRRER 7, complete package

Universal magnetic stirrer with an outstanding price-performance ratio. Safety features include a **"hot" warning display** and a stirring function that continues to run until the plate temperature is below 50 °C, even when the device is switched off. An integrated control function offers precise control of the heated fluid temperature via a remote PT1000 temperature probe. The device is equipped with a stainless steel plate with glass ceramic (184 x 184 mm).

- Latest generation magnetic stirrer/hotplate
- Maintenance-free, brushless DC motor
- Digital control and **backlit display**
- Stirrer and display can be controlled remotely via an RS232 interface
- Hot surface indicator
- Stainless steel plate with glass ceramic
- Sturdy metal housing
- Powerful stirring
- Connection for PT1000, integrated control function
- Mountable rod on the left and on the right side of the stirrer

Delivery includes: Magnetic stirrer with PT1000 probe, rod and holder

Specifications

Stirring quantity (H ₂ O):	20 l
Speed range:	100 to 1500 rpm
Accuracy:	±1 rpm
Magnetic bar:	80 mm
Display:	LCD
Heating plate:	184 x 184 mm/ stainless steel plate with glass ceramic
Permissible ambient temperature:	5 to 40 °C
Temperature range:	ambient to 550 °C
Setting accuracy:	±0.1 °C
Control accuracy:	±0.2 °C
Heat output:	1000 W
Safety temperature:	100 to 580 °C
Dimensions (W x D x H):	215 x 360 x 112 mm
Weight:	5.3 kg
Power supply:	200 - 240 V, 50/60 Hz
Protection class:	IP 42
Warranty:	3 years

Type	PK	Cat. No.
LLG-uniSTIRRER 7 with EU-plug	1	6.263 450
LLG-uniSTIRRER 7 with UK-plug	1	6.263 451

1

2

Temperature sensors LLG-uniSTIRRER 3/LLG-uniSTIRRER 5/LLG-uniSTIRRER 7

Description	PK	Cat. No.
PT1000 temperature sensor	1	6.263 415

1 | 2 | LLG-RCT standard safety control

Magnetic stirrer with new technology and new functions:

- integrated temperature control
- incl. PT 1000 temperature sensor (PT 1000.60)
- exact temperature and speed setting via digital display, even when switched off
- digital display of set safety temperature limit
- hot top indicator, hot surface warning to prevent burns
- digital error code display
- with adjustable safety circuit of heating plate temperature (50 to 360 °C)
- safety magnetic stirrer with heating, suitable for unsupervised operation
- DIN 12878 connector for attaching a contact thermometer, e.g. ETS-D5; enables precise temperature control directly in the heated medium
- enhanced safety due to improved heat control technology
- enclosed assembly (IP42) guarantees long service life
- highly polished, aluminium hotplate for optimal heat transfer
- improved magnetic coupling
- supplied with housing protection cover H 98

Specifications

Drive unit

Stirring quantity (H ₂ O):	20 L
Motor rating input/output:	16/9 W
Speed display:	digital
Speed range:	50 to 1500 rpm
Max. magnetic bar (L x dia.):	80 x 10 mm

Heating function

Speed display:	digital
Heat output:	600 W
Heating rate (1 litre H ₂ O in H 15):	6.5 K/min
Temperature range:	RT to 310 °C
Setting accuracy:	±1 K
Temp. variation without temp. sensor:	±2 K
Adjustable safety circuit:	50 to 360 °C
Control accuracy with sensor:	PT 1000/±1 K ETS-D5/±0.5 K ETS-D6/±0.2 K

Heating plate

Material:	aluminium alloy
Dimensions:	135mm dia.

General data

Dimensions (W x D x H):	160 x 270 x 85 mm
Weight:	2.5kg
Operating temperature range:	5 to 40 °C
Operating humidity range:	80 % R.H.
Protection class acc. to DIN EN 60529:	IP42
Tested to DIN EN IEC 61010-1.	

Type	PK	Cat. No.
RCT Standard safety control incl. PT 1000 with EU-plug	1	9.720 250
RCT Standard safety control incl. PT 1000 with UK-plug	1	6.242 087
RCT Standard safety control incl. PT 1000 with CH-plug	1	4.008 142

Optional accessories: Electronic contact thermometer ETS-D5, Ikaflon® stirring bars, Trika® stirring bars, RS 1 stirring bar set, RSE Stirring bar remover, Quarter System, Reaction block System



1 2 3 LLG-Universal reaction block system for magnetic stirrers

Universal alternative to oil bath

The reaction block allows syntheses to be carried out in round flasks at temperatures of up to 250 °C. As a result, with this system, oil as a heat transfer media is made redundant and your lab is a safer place. The reaction block ensures safety at work and prevents oil baths and heating mantles from overheating in your lab. The messy oil clean-ups that results from changing oil or removing flasks from an oil bath will be eliminated. Injuries and burns from hot oil will never happen again. Uniform mixing is also guaranteed because there is no interference to the magnetic field from the aluminium blocks. This system ensures optimal heat transfer from the heating plate directly into the medium.

- **Universal model**
- **For round plates of 135 to 145 mm diameter**
- **With adapter plate for all square plates of min. 145 mm length side**

- Reaction blocks are available in six standard sizes.
- Delivered adapter allows the use with either IKA or Heidolph magnetic stirrers.
- Syntheses in round flasks without oil bath up to 250 °C.
- Uniform and constant mixing
- High-precision thermal conduction directly into the reaction block
- Safe and clean working
- Made in Germany

Description	PK	Cat. No.
LLG-Universal reaction block system 50 ml	1	9.728 890
LLG-Universal reaction block system 100 ml	1	9.728 891
LLG-Universal reaction block system 250 ml	1	9.728 892
LLG-Universal reaction block system 500 ml	1	9.728 893
LLG-Universal reaction block system 1000 ml	1	9.728 897
LLG-Universal reaction block system 2000 ml	1	9.728 898
Spare adapter ring for reduction from 145 mm to 135 mm, for attachment 50 to 500 ml	1	9.728 894
Spare adapter ring for reduction from 145 mm to 135 mm, for attachment 1000 and 2000 ml	1	9.728 899
Adapter plate for rectangular hotplates, for attachment 50 to 500 ml	1	9.728 895
Adapter plate for rectangular hotplates, for attachment 1000 and 2000 ml	1	9.728 900
2 spare screws and 1 wrench, for attachment 50 to 500 ml	1	9.728 896
2 spare screws (countersunk), for attachment 1000 and 2000 ml	1	9.728 901

1



2



3



1 2 Overhead stirrer LLG-uniSTIRRER OH2, digital

Cost efficient laboratory stirrer designed for simple stirring tasks for quantities up to 20 l (H₂O). Automatic speed adjustment in the range between 50 and 2200 rpm via microprocessor controlled technology. Safety circuits ensure automatic cut-off in an anti-stall or overload situations. Actual and set speed are constantly detected ensuring no undesired speed variations even if the sample viscosity changes.

- Brushless, maintenance free motor
- Digital speed display
- **Display for speed or torque changeable**
- Infinitely adjustable speed
- **Overload protection**
- Slim casing
- Quiet operation
- Error code display
- RS232 port

Stand:

Stainless steel stand incl. boss head, dimension (W x D x H): 200 x 310 x 780 mm

Stirrer:

4-blade propeller stirrer, stainless steel, shaft length 400 mm, stirrer diameter 50 mm

Scope of delivery: Overhead stirrer LLG-uniSTIRRER OH2, stand and 4-blade-propeller stirrer.

Specifications

Max. stirring quantity (H ₂ O):	20 l
Speed range:	50 to 2200 rpm
Max. viscosity:	10.000 mPas
Motor rating input/output:	60/50 W
Speed display accuracy:	3 rpm
Max. torque at stirring shaft:	40 Ncm
Display:	LCD
Chuck range:	0.5 to 10 mm
Dimensions (W x D x H):	83 x 186 x 220 mm
Power supply:	110 - 240 V, 50/60 Hz
Protection class:	IP 21
Warranty:	3 years

Type	PK	Cat. No.
LLG-uniSTIRRER OH2 with EU-plug	1	6.263 455
LLG-uniSTIRRER OH2 with UK-plug	1	6.263 456
4-blade propeller stirrer, diam. 50, shaft diam. 8, 400 mm	1	6.263 454
2-blade propeller stirrer, diam. 60, shaft diam. 8, 400 mm	1	6.263 457
3-hole paddle stirrer, diam. 67, shaft diam. 8, 400 mm	1	6.263 458

1



2



3 Test tube shaker LLG-uniTEXER 1

Compact and cost-efficient test tube shaker with brushless motor drive and touch function for short-term operation. Adjustable speed control up to 4500 rpm for excellent mixing results in a very short time. Especially for small volumes.

Specifications

Type of movement:	orbital
Orbit:	4.5 mm
Speed range:	0 to 4500 rpm
Permissible ambient temperature:	5 to 40 °C
Permissible relative moisture:	< 80 %
Dimensions (W x D x H):	100 x 100 x 70 mm
Weight:	0.55 kg
Power supply:	100 - 240 V, 50/60 Hz
Protection class:	IP 43
Warranty:	3 years

Type	PK	Cat. No.
LLG-uniTEXER 1 with EU-plug	1	6.263 490
LLG-uniTEXER 1 with UK-plug	1	6.263 491
Silicone cap for LLG-uniTEXER 1	1	6.263 492

3



1 2 3 4 Vortexer LLG-uniTEXER with universal attachment

One head - multiple uses

Vortexer with single carrier head, accommodating the most popular consumables and tubes: for 1 x assay plate, 2 x 50 ml conical tubes, 2 x 15 ml conical tubes, 2 x 5 ml conical tubes, 4 x 1.5/2 ml microcentrifuge tubes, 6 x 0.5 ml and 24 x 0.2 ml microcentrifuge tubes.

- Touch function for short-term operation
- Very easy to clean
- Elastomeric feet ensure excellent stability on the bench
- Modern design
- Robust housing made of ABS

Specifications

Type of movement:	orbital/vortex
Orbital diameter:	3.7 mm
Speed:	1000, 2000 und 3000 rpm
Dimensions (W x D x H):	173 x 198 x 198 mm
Weight:	3.8 kg
Power supply:	220 V, 50/60 Hz
Protection class:	IP 20
Warranty:	3 years



Type	PK	Cat. No.
LLG-uniTEXER	1	6.261 826

2



3



4



5 Mixing head with multiple loading possibilities

- a Center pad area for hand held mixing
- b Assay plate x 1 (to be used with retention cords)
- c 50 ml conical tubes x 2 (horizontally mounted)
- d 15 ml tubes x 2 (horizontally mounted)
- e 5 ml tubes x 2 (horizontally mounted in the same retention space as 15 ml)
- f 1.5/2 ml microfuge tubes x 4 (vertically mounted)
- g 0.5 ml microfuge tubes x 6 (vertically mounted)
- h 0.2 ml microfuge tubes (strip tubes) x 24 (vertically mounted)

5

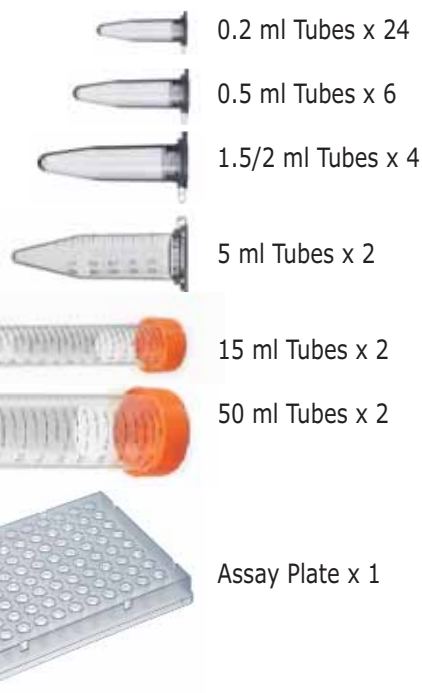
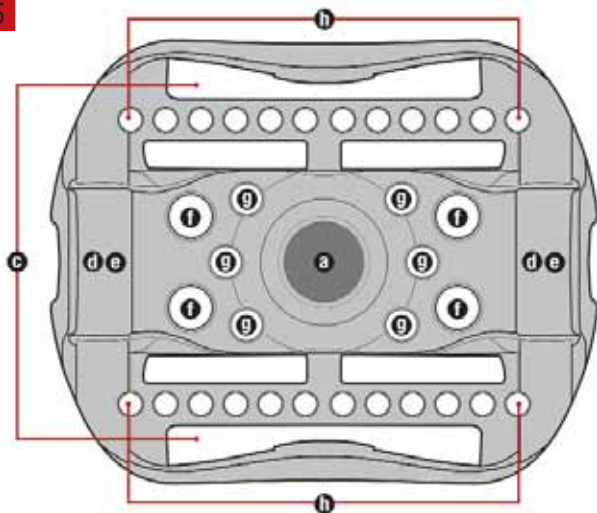

1 2 Orbital shaker LLG-uniSHAKER 25

Powerful, smooth running orbital shaker for **loads up to 25 kg**. The maintenance free brushless motor and the shaking mechanism with counter weight allow any time smooth and stable operation. Digital display for speed and time. Adjustable speed from 50 to 500 rpm, built-in timer from 1 to 99 minutes or continuous. Two different platforms (610 x 460 mm or 760 x 460 mm) and 7 clamps for vessels from 25 ml to 2000 ml available. Platforms and clamps must be ordered separately.

- **Stable and robust metal housing**
- **Maximum load capacity 25 kg**
- Shaking orbit 25 mm
- Different platforms and clamps available

Specifications

Type of movement:	orbital
Orbit:	25 mm
Speed range:	50 to 500 rpm
Max. Load:	25 kg
Motor:	brushless DC motor
Timer:	0 - 99 minutes, continuous
Power consumption:	250 VA
Permissible ambient temperature:	4 to 75 °C
Dimensions (W x D x H):	600 x 550 x 150 mm
Weight:	48 kg
Power supply:	230 V, 50 Hz
Warranty:	3 years

Type	PK	Cat. No.
LLG-uniSHAKER 25 with EU-plug	1	6.263 590
LLG-uniSHAKER 25 with UK-plug	1	6.263 599
Universal attachment, 610 x 460 mm	1	6.263 591
Universal attachment, 610 x 460 mm, with securing bars	1	6.263 589 a
Universal attachment, 760 x 460 mm	1	6.263 592
Clamp, 100 ml	1	6.263 593
Clamp, 250 ml	1	6.263 594
Clamp, 500 ml	1	6.263 595
Clamp, 1000 ml	1	6.263 596
Clamp, 2000 ml	1	6.263 597
Adhesive rubber mat, blue, 150 x 150 x 3 mm	2	6.263 598

1



2



3



6.263 589

4 Tumbling Shaker LLG-uniSHAKER 2

Multi-functional shaker with dimpled mat, perfect for foam-free mixing of blood and other biological samples in centrifuge tubes. Suitable for a variety of tubes and dishes.

Specifications

Type of movement:	tumbling
Tumbling angle:	20°
Speed:	fixed, 20 rpm
Max. Load:	1.6 kg
Ambient Temperature:	4 to 45 °C
Platform Dimensions (W x D):	202.5 x 152.5 mm
Dimensions (W x D x H):	202.5 x 152.5 x 202.5 mm
Weight:	2 kg
Power supply:	230 V, 50 Hz, 0.2 A
Warranty:	3 years

4



Type	PK	Cat. No.
LLG-uniSHAKER 2 with EU-plug	1	6.263 640
LLG-uniSHAKER 2 with UK-plug	1	6.263 641

1

1 Thermo shaker LLG-uniTHERMIX 1 and 2

The LLG-uniTHERMIX is ideal for shaking and temperature control of a variety of tubes or plates (depending on the block used). With its high temperature uniformity, fast heating rate and excellent mixing results the LLG-uniTHERMIX is perfect for the incubation of samples of any kind, in particular for Life Science applications, e.g. Enzyme reactions, transformations, denaturation of DNA and RNA.

- Precise temperature control system
- Temperatures up to 100 °C
- Temperature accuracy of ± 0.5 °C (20 to 45 °C)
- Efficient mixing up to 1500 rpm (depending on the heating block)
- Up to 9 storable programs
- Many block options available (see below)
- Automatic block recognition

LLG-uniTHERMIX 1: with shaking and heating function, Temperature range: RT + 5 °C to approx. + 100 °C

LLG-uniTHERMIX 2: with shaking, cooling and heating function, Temperature range: 15 °C below RT to approx. +100 °C

Blocks must be ordered separately.

Specifications

Temperature range	
LLG-uniTHERMIX 1:	RT + 5 °C to approx. + 100 °C
LLG-uniTHERMIX 2:	15 °C below RT to approx. + 100 °C
Temperature control:	± 0.5 °C (at 20 to 45 °C)
Uniformity:	Max. ± 0.5 °C (at 20 to 45 °C)
Max. heating rate:	5.5 °C/min
Max. cooling rate (LLG-uniTHERMIX 2 only):	5 °C/min (100 °C to RT)
	0.5 °C/min (below RT)
Speed range:	300 to 1500 rpm
Orbit:	3 mm
Display:	LCD
Programs:	6 stages, 9 programs
Timer:	1 to 99 min or continuous
Capacity:	1 exchangeable block*
Dimensions (W x D x H):	200 x 235 x 120 mm
Weight:	7.3 kg
Electrical heating/cooling power:	200 W
Power supply:	220 - 240 V, 50/60 Hz
Warranty:	3 years

Type	PK	Cat. No.
LLG-uniTHERMIX 1 with EU-plug	1	6.263 470
LLG-uniTHERMIX 1 with UK-plug	1	6.263 471
LLG-uniTHERMIX 2 with EU-plug	1	6.263 472
LLG-uniTHERMIX 2 with UK-plug	1	6.263 473

*Exchangeable blocks are not included in delivery.

2

2 Heating blocks for Thermo shaker LLG-uniTHERMIX 1 and 2

For	PK	Cat. No.
96 well PCR plates non-skirted, 0.2 ml tubes*	1	6.263 474
96/384 micro plate*	1	6.263 480
24 tubes, 0.5 ml*	1	6.263 475
24 tubes, 1.5 ml*	1	6.263 476
24 tubes, 2.0 ml*	1	6.263 477
8 tubes, 5 ml	1	6.263 481
8 tubes, 15 ml, max. 800 rpm	1	6.263 478
4 tubes, 50 ml, max. 600 rpm	1	6.263 479

*with lid

1 Overhead mixer LLG-uniROTATOR 2

Analogue overhead mixer with vertical rotary motion for gentle but effective mixing. Ideal for biological samples. Suitable for cutting and mixing processes of powdered and liquid samples in tubes up to 50 ml. With easily interchangeable clamps that allow a quick cleaning of the mixer.

- Compact design
- Housing easy to clean
- Non-slip, adjustable screw feet

Scope of delivery: Overhead mixer incl. 12 clamps each for 2 ml, 15 ml and 50 ml tubes

Specifications

Type of movement:	overhead
Variable speed:	0 - 80 rpm
Rotation angle:	360°
Permissible shaking weight (incl. attachment):	2 kg
Motor rating input:	20 W
Dimensions (W x D x H):	530 x 150 x 190 mm
Power supply:	100 - 240 V, 50/60 Hz
Protection class:	IP 21
Warranty:	3 years

Type	PK	Cat. No.
LLG-uniROTATOR 2 with EU-plug	1	6.263 660
LLG-uniROTATOR 2 with UK-plug	1	6.263 661
Clamp for 2 ml centrifuge tube	12	6.263 662
Clamp for 15 ml centrifuge tube	12	6.263 663
Clamp for 50 ml centrifuge tube	12	6.263 664

1



2 Disc rotator LLG-uniLOOPMIX 2

Analogue Disc rotator for gentle and effective sample mixing. Suitable for all biological samples. With easily interchangeable clamps that allow a **quick cleaning** of the rotator.

For a maximum of 48 x 1.5 ml, 16 x 5 or 15 ml, 8 x 50 ml tubes.

Also for parallel use of different sizes, can be equipped individually.

- Variable speed 0 - 80 rpm
- Compact design
- Housing easy to clean
- Non-slip, adjustable screw feet

Scope of delivery: Disc rotator incl. 12 clamps each for 2 ml, 15 ml and 50 ml tubes

Specifications

Type of movement:	rotating
Variable speed:	0 - 80 rpm
Rotation angle of disc:	360°
Permissible shaking weight (incl. attachment):	2 kg
rel. Moisture:	up to max 80 %
Working temp.:	+ 5 - 40 °C
Motor rating input/output:	20 W
Dimensions (W x D x H):	220 x 300 x 310 mm
Power supply:	100 - 240 V, 50/60 Hz
Protection class:	IP 21
Warranty:	3 years

2



Type	PK	Cat. No.
LLG-uniLOOPMIX 2 with EU-plug	1	6.263 665
LLG-uniLOOPMIX 2 with UK-plug	1	6.263 666



1 Roller Mixers LLG-uniROLLER 6 and 10, digital

Digital tube rollers **with 6 or 10 rolls** for the efficient mixing of biological samples, viscous substances and liquid-solid suspensions. The LLG-uniROLLER 6 and 10 are equipped with very easily detachable rollers enabling the user to adjust the space to hold tubes and bottles of different diameter and to quickly clean and decontaminate the unit in case of sample spillage.

- **Detachable rollers for very easy cleaning** in case of sample spills
- Speed ranging from 10 to 80 rpm
- Timer from 1 min to 99 min and continuous mode
- **Pulse mode feature for increased mixing efficiency**
- Microprocessor controller for accurate speed under variable load
- Brushless DC motor for quiet operation and maintenance free long life
- **Digital display**
- Save up to 9 user defined programs
- **Can be used in incubators up to 40 °C and humidity up to 80 %**
- Stackable design
- Tilting and rolling movement for ideal mixing

Specifications

Type of movement:	rocking and rolling
Amplitude:	24 mm
Load max.:	2 kg
Ambient temperature:	10 to 40 °C
Max. humidity:	up to 80 %
Roller size (l x Ø):	330 x 30 mm
Power supply:	100 - 240 V, 50/60 HZ
Protection class:	IP 21
Warranty:	3 years

Type	Dimensions (W x D x H) mm	Rollers	PK	Cat. No.
LLG-uniROLLER 6, with EU plug	502 x 301 x 92.5	6	1	6.263 650
LLG-uniROLLER 6, with UK plug	502 x 301 x 92.5	6	1	6.263 651
LLG-uniROLLER 10, with EU plug	502 x 301 x 92.5	10	1	6.263 652
LLG-uniROLLER 10, with UK plug	502 x 301 x 92.5	10	1	6.263 653



2 3 Microtitre shaker LLG-uniPLATESHAKER 1

The LLG-uniPLATESHAKER 1 has been designed for accommodating and mixing a single micro plate. Due to its **small footprint** it can be used in working areas with limited space such as fume hoods and bio safety cabinets. It can also be used inside a cold-room.

- Digital Display with Speed and Time settings
- **Variable speed** from 300 to 1800 rpm
- Maintenance free brushless DC motor
- Orbital Diameter of 2 mm for thorough mixing
- Timer setting from 1 to 99 min and continuous mode
- **Universal fit;** comes with interchangeable clamps for different micro plate sizes
- Comes with foam attachment for 20 x 1.5/2 ml microtubes

Specifications

Type of movement:	orbital
Orbital diameter:	2 mm
Speed range:	300 to 1800 rpm
Motor:	brushless DC motor
Timer:	1 to 99 min, continuous
Power consumption:	15 W
Permissible ambient temperature:	4 to 40 °C
Dimensions (W x D x H):	127 x 85 x 86 mm
Weight:	1.4 kg
Power supply:	100 - 230 V, 50/60 HZ
Warranty:	3 years



Type	PK	Cat. No.
LLG-uniPLATESHAKER 1 with EU-plug	1	6.263 488
LLG-uniPLATESHAKER 1 with UK-plug	1	6.263 489

1 LLG-Sampling Dippers, PS, sterile, with screw cap and handle

Blue sample container with PP lid (30 ml) or metal cover with PVC seal (100 ml, 250 ml).

Easy to transport after sampling by breaking the handle.

- For sterile sample collection and dispatch
- To minimize the risk of cross contamination
- Individually wrapped and EO sterilised
- Leakproof-tested screw cap
- Handle easily breakable after sampling

Capacity ml	Length Handle mm	Material container	Material Lid	PK	Cat. No.
30	200	PS	PP	50	6.265 643
100	385	PS	metal	50	6.265 644
250	330	PS	metal	50	6.265 645

1



2 Sampling scoops and spoons, PS, sterile

- White or red high-impact polystyrene plastic.
- Individually sealed and sterilised in a polyethylene bag ready for one time use and disposal
- Long handle increases the distance between the hand and the sample
- Scoop is suitable for use as weighing boat
- Red colored scoops reduces the chance of residual sample staying in the scoop or the scoop being accidentally left behind in a sample
- Colour can serve as a code to avoid cross contamination
- Made from FDA grade materials
- Lot stamped for accurate lot tracing; shipped with a Certificate of Processing for Sterilization

Type	Capacity ml	Colour	PK	Cat. No.
Scoop	60	white	1	9.150 461
Scoop	125	white	1	9.150 462
Scoop	250	white	1	9.150 463
Scoop	60	red	1	9.150 464
Scoop	125	red	1	6.242 234
Scoop	250	red	1	9.150 465
Spoon	1,25	white	1	9.150 639
Spoon	2,46	white	1	9.150 640
Spoon	4,93	white	1	9.150 641
Spoon	14,79	white	1	9.150 642

Other sampling devices are available on request.

2



3 Whirl-Pak® Sample bags, PE, sterile

Whirl-Pak® bags are sterile polyethylene laboratory sample bags used to transport samples for biological testing and other applications. With or without write-on strip. Bags should not be used at temperatures above 82 °C. Bags can be frozen to any temperature, even liquid nitrogen temperatures down to -210 °C - careful handling required after freezing.

Description	Filling volume approx ml	Dimensions (D x W)		Thickness mm	PK	Cat. No.
		mm	mm			
with label	58	75 x 125	0,057	500	7.058 005	
with label	118	75 x 185	0,057	500	7.077 212	
with label	207	95 x 180	0,064	500	6.286 123	
with label	532	115 x 230	0,064	500	7.058 120	
with label	710	150 x 230	0,076	500	6.242 083	
with label	5441	380 x 508	0,102	100	6.257 989	
with label	2721	254 x 380	0,102	250	6.266 304	
without label	58	75 x 125	0,057	500	6.091 055	
without label	207	95 x 180	0,076	500	7.981 345	
without label	532	115 x 230	0,064	500	9.404 235	
without label	710	150 x 230	0,076	500	6.228 639	
without label	2041	190 x 380	0,076	500	6.305 117	

3



1

1 Whirl-Pak® Sample bags, PE, sterile, free standing

The Whirl-Pak® Stand-Up Bags make sample handling and testing much easier. They give users the ability to perform important laboratory functions with both hands, because the bag will stand completely by itself. No rack or other holder is needed to keep the bag upright. When the sample is placed inside, the specially gusseted bottom flattens out, allowing the bag to stand up on its own. It works just like a beaker or bottle, however, it costs less, is sterilized, won't break, and uses only a fraction of storage space as the other containers.

The white, easy-to-write-on strip makes sample identification easier and more convenient.

Bags should not be used at temperatures above 82 °C. Bags can be frozen to any temperature, even liquid nitrogen temperatures down to -210 °C - careful handling required after freezing.

Description	Filling volume approx ml	Dimensions (D x W) mm		PK	Cat. No.
			Thickness mm		
with label, free standing	532	115 x 230	0.076	500	9.404 232
with label, free standing	1065	125 x 380	0.102	250	6.260 542

2

2 Whirl-Pak® Sample bags/Homogenizing bags, PE, sterile

- Sterile, solid bags for the homogenization of liquids and solids
- With and without labelling strips

Description	Filling volume approx ml	Dimensions (D x W) mm		PK	Cat. No.
			Thickness mm		
without label	384	130 x 190	0.076	500	6.052 018
with label	710	150 x 230	0.102	500	7.059 854
with label	1627	190 x 300	0.102	500	7.059 855

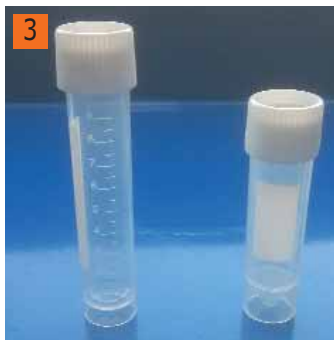
3

3 LLG-Transport tubes, PP, with screw cap

For convenient storage and dispatch of samples.

- Conical bottom
- Free standing
- Printed graduation
- 1 1/4 turn thread design for super fast screwing

Capacity ml	Outer diam. mm	Height with cap mm	PK	Cat. No.
5	16	60	100	6.265 667
10	16	80	100	6.265 668

4

4 Sample bottles, PP, for water sampling, sterile

These gamma sterilised bottles are specially designed for taking, handling, transporting and storing water samples. Manufactured either as clear or amber colour from low density polypropylene. Clear bottles are manufactured from glass-like transparent special grade polypropylene. Square body form offers easy handling, and optimum space saving solutions during storage period. Wide bottle neck (GL 50) provides easy filling and pouring. Cap is made from high density polypropylene with self sealing lock with integral security ring. Unique cap inner design ensures hermetical closure and guarantees an excellent leak and contamination proof bottle. Embossed graduation (precision of ±2 %) on side wall enables volume verifications. Each bottle is labelled specifying e.g. sample and source descriptions, code and lot numbers and expiry date.

Bottles with liquid sodium thiosulfate (20 mg/lit - acc to ISO/FDIS 19458:2006) are ideal to analyse water meant for human consumption, swimming pools, and any other water where chlorine may modify the composition of the sample. Empty bottles, without sodium thiosulfate ; ideal to sample water for physical and chemical analysis, as well as for other sample requirements that demands sterile bottles.

Single packed bottles available on request.

Description	Capacity ml	PK	Cat. No.
clear, sterile, without sodium thiosulfate	250	108	9.001 075
clear, sterile, without sodium thiosulfate	500	84	9.001 076
clear, sterile, without sodium thiosulfate	1000	30	9.001 077
clear, sterile, with sodium thiosulfate	250	108	9.001 081
clear, sterile, with sodium thiosulfate	500	84	9.001 082
clear, sterile, with sodium thiosulfate	1000	30	9.001 083

1 LLG-Mortars only, porcelain

Description	Capacity	Ext. diam. mm	Height mm	DIN	PK	Cat. No.
	ml					
rough inside	25	51	32		1	9.164 410
rough inside	70	63	41	12906	1	6.227 149
rough inside	75	76	45		1	9.164 411
rough inside	110	83	50		1	6.232 577
rough inside	160	90	56	12906	1	6.243 865
rough inside	220	105	64		1	9.164 412
rough inside	400	125	71	12906	1	9.164 413
rough inside	2250	224	127		1	6.252 383
glazed inside	110	83	50		1	6.227 289
glazed inside	220	105	64		1	6.234 591

1



2 LLG-Pestle only, porcelain

Description	Head diam.	Length mm	DIN	PK	Cat. No.
	mm				
rough	14	54		1	6.227 150
rough	24	115	12906	1	9.164 420
rough	30	135	12906	1	6.232 574
rough	36	150	12906	1	9.164 421
rough	42	175	12906	1	9.164 422
rough	74	250	12906	1	6.252 384
glazed	42	175	12906	1	6.227 292
glazed	36	150	12906	1	6.234 592

2



3 Mortars and pestles, Agate

Agate. Polished. Standard quality. Other sizes available on request.

Capacity	Ext. diam. mm	Int. diam. mm	PK	Cat. No.
ml				
10	50	40	1	9.164 050
25	75	60	1	9.164 075
50	100	85	1	9.164 100
100	125	100	1	9.164 125

3





1 Round bottom flasks, borosilicate glass 3.3

Manufactured from borosilicate glass 3.3. Resistant to heat and almost all chemicals. According to DIN 12394. Reinforced rims are used to prevent breaking during washing and transportation.

Capacity	Flask diam.	Neck diam. approx.	Height	Socket	PK	Cat. No.
ml	mm	mm	mm	NS		
50	51	22	105	14/23	1	6.236 508
50	51	22	100	19/26	1	4.008 379
50	51	30	100	24/29	1	4.008 380
50	51	34	105	29/32	1	6.238 345
100	64	22	115	14/23	1	6.236 346
100	64	22	110	19/26	1	4.008 381
100	64	30	110	24/29	1	4.008 382
100	64	34	115	29/32	1	6.236 774
250	85	22	140	19/26	1	4.008 383
250	85	30	140	24/29	1	4.008 384
250	85	34	145	29/32	1	6.236 303
500	105	30	170	24/29	1	4.008 385
500	105	34	175	29/32	1	6.240 426
1000	131	42	200	29/32	1	6.242 240
2000	166	34	260	29/32	1	6.238 472



2 Round bottom flasks with two necks, angled arm, borosilicate glass 3.3

Manufactured from borosilicate glass 3.3. Conformed to DIN 12394. The side arms are 45 degree angled with each other. NS necks are in compliance with DIN 12242 standards. Two-necked round-bottomed flask available with parallel side arm on request.

Capacity	Centre neck	Angled side necks	PK	Cat. No.
ml	NS	NS		
50	14/23	14/23	1	9.140 320
100	14/23	14/23	1	9.140 321
100	29/32	14/23	1	6.243 616
250	29/32	14/23	1	4.008 386
500	29/32	14/23	1	4.008 387



3 Three-neck round-bottom flasks, side necks angled, DURAN®

DIN 12394 and in addition to standard (*). Central neck with 2 x 20° angled side necks.

Capacity	Flask diam.	Centre neck	Side necks	PK	Cat. No.
ml	mm	NS	NS		
50	51	19/26	14/23*	1	6.202 804
100	64	29/32	14/23*	1	9.011 953
250	85	29/32	14/23	1	9.011 955
250	85	29/32	29/32	1	9.011 956
500	105	29/32	14/23*	1	9.011 958
500	105	29/32	29/32	1	9.011 959
1000	131	29/32	14/23	1	9.011 961
1000	131	29/32	29/32*	1	9.011 962



4 Flat bottom flasks, NS joint neck, borosilicate glass 3.3

Borosilicate glass 3.3. Resistant to heat and almost all chemicals. According to DIN 12394.

Capacity	Socket	Height	PK	Cat. No.
ml	NS	mm		
50	29/32	100	1	4.008 377
100	29/32	110	1	6.236 773
250	24/29	140	1	6.243 613
250	29/32	140	1	6.238 346
500	29/32	170	1	6.240 425

1 Flask rings, pressed cork

Height 30 mm.

For flasks ml	Ext. diam. mm	Int. diam. mm	PK	Cat. No.
10 - 100	80	30	1	9.143 003
250 - 500	110	60	1	9.143 006
1000 - 2000	140	90	1	9.143 009
3000	170	120	1	9.143 012



2 Erlenmeyer flasks, NS neck, borosilicate glass 3.3

Borosilicate glass 3.3. Conformed to DIN EN ISO 4797. NS necks are in compliance with DIN 12242 standards. Inscriptions are in white enamel which is specially designed for glass use.

Capacity ml	Height mm	Socket NS	PK	Cat. No.
50	85	14/23	1	9.141 105
50	85	19/26	1	9.141 106
50	85	29/32	1	9.141 107
100	100	14/23	1	9.141 108
100	100	29/32	1	9.141 109
250	140	29/32	1	9.141 110
300	156	29/32	1	9.141 111
500	175	29/32	1	9.141 112
1000	220	29/32	1	9.141 113



3 Erlenmeyer flasks, NS neck, borosilicate glass 3.3, amber

Borosilicate glass 3.3, amber. Conformed to DIN EN ISO 4797. NS necks are in compliance with DIN 12242 standards.

Capacity ml	Height mm	Socket NS	PK	Cat. No.
50	85	29/32	1	9.140 400
100	100	29/32	1	6.258 244
250	140	29/32	1	6.258 150
500	175	29/32	1	6.255 806
1000	220	29/32	1	9.140 401
2000	270	29/32	1	9.140 402

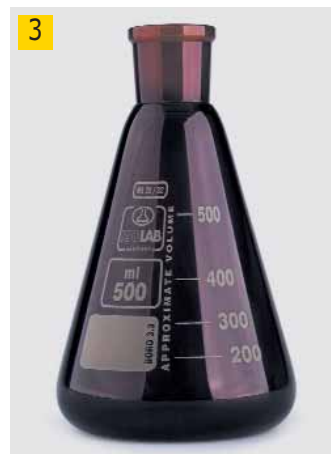

4 Evaporator flask pear shape, borosilicate glass 3.3

Manufactured from borosilicate glass 3.3, according to DIN 12383. Pear shaped Evaporator flask with NS 29/32, suitable for all Rotary evaporators.

Capacity ml	NS	PK	Cat. No.
100	29/32	1	6.237 167
250	29/32	1	6.237 711
500	29/32	1	6.243 664
1000	29/32	1	6.236 112





1 Dropping funnels, cylindrical, with or without pressure equalizing tube, Borosilicate glass 3.3

Borosilicate glass 3.3. PTFE stopcock, PP stoppers. cylindrical shape, with or without pressure equalising tube. DIN 12451 and DIN 12567.

Type	Capacity	Cone	Socket	PK	Cat. No.
	ml	NS	NS		
with relief tube	50	29/32	19/26	1	9.140 415
with relief tube	100	29/32	19/26	1	4.008 428
with relief tube	250	29/32	29/32	1	6.240 982
with relief tube	500	29/32	29/32	1	6.240 983
without relief tube	50	29/32	19/26	1	9.140 410
without relief tube	100	29/32	19/26	1	9.140 411
without relief tube	250	29/32	29/32	1	9.140 412
without relief tube	500	29/32	29/32	1	9.140 413
without relief tube	1000	29/32	29/32	1	9.140 414



2 Condensers, ground glass joint, Dimroth, borosilicate glass 3.3.

Made of borosilicate glass 3.3. Resistant to heat and almost all chemicals. According to DIN 12591. Supplied with glass side arms. The side arms accept tubing with 8/9 mm bore size.

Effective length mm	Cone	Socket	PK	Cat. No.
	NS	NS		
160	14/23	14/23	1	9.012 525
160	29/32	29/32	1	9.012 526
250	14/23	14/23	1	9.012 527
250	29/32	29/32	1	6.258 228
400	29/32	29/32	1	6.243 670



3 Spiral condensers, borosilicate glass 3.3

Made of borosilicate glass 3.3 which is resistant to heat and almost all chemicals. They meet the highest quality standards according to DIN 12592. Supplied with either glass side arm or polypropylene side arm. Polypropylene side arm has a screw thread connector for easy and safe fitting of the tubing. The side arms accept tubings with 8/9 mm bore size.

Description	Effective length mm	NS	PK	Cat. No.
with glass side arm	160	14/23	1	9.012 548
with glass side arm	250	29/32	1	6.257 821
with glass side arm	400	29/32	1	4.008 411
with PP side arm	250	29/32	1	6.257 820
with PP side arm	400	29/32	1	4.008 414



4 Condensers, ground glass joint, Liebig, borosilicate glass 3.3

Made of borosilicate glass 3.3 which is resistant to heat and almost all chemicals. They meet the highest quality standards according to DIN 12576. Polypropylene side arm has a screw thread connector for easy and safe fitting of the tubing. The side arms accept tubings with 8/ 9 mm bore size.

Description	Effective length mm	NS	PK	Cat. No.
with PP side arm	250	29/32	1	9.012 546
with PP side arm	400	29/32	1	4.008 405
with glass side arm	250	29/32	1	7.970 278
with glass side arm	400	29/32	1	6.236 239
with glass side arm	160	14/23	1	9.012 535
with glass side arm	250	14/23	1	9.012 536

1 Boiling stones, Type A

Developed for use in preparatory work. For distillation and reflux in aqueous, neutral and alkaline solvents, even under a vacuum. Effective in even the smallest volumes of liquid and after multiple interruptions. Prevents any bumping. Natural product.

Capacity	PK	Cat. No.
g 250	1	9.012 306

1



2 Boiling stones, Type B

Specifically for analytical work. Can be used for distillation in a clean, neutral and basic environment. Not suitable for vacuum distillation. Effective in the smallest amounts of liquid, also after multiple distillations. Prevents "bumping". Ceramic product with relatively high level of purity and abrasion resistance.

Capacity	PK	Cat. No.
g 200	1	9.012 307

2



3 Separating funnels, Squibb-pattern, borosilicate glass 3.3

Supplied with PTFE stopcock. According to DIN 12452. With PP conical stopper.

Description	Capacity	Bore	NS	PK	Cat. No.
	ml	mm			
graduated	50	2.5	19/26	1	6.236 317
graduated	100	2.5	19/26	1	6.236 318
graduated	250	4.0	29/32	1	6.236 319
graduated	500	4.0	29/32	1	6.236 320
graduated	1000	6.0	29/32	1	6.236 321
graduated	2000	6.0	29/32	1	6.240 412

3



4 Soxhlet extractors, without stopcock

Borosilicate glass 3.3 which is resistant to heat and almost all chemicals. They meet the highest quality standards according to DIN 12602.

Capacity	Cone	Socket	PK	Cat. No.
ml	NS	NS		
30	29/32	29/32	1	4.008 417
70	29/32	34/35	1	4.008 418
100	29/32	45/40	1	4.008 419
150	29/32	45/40	1	4.008 420
250	29/32	45/40	1	4.008 421

4



5 LLG-Extraction thimbles, cellulose

Neutral and fat free. With excellent retention capacity.

Diam.	Length	PK	Cat. No.
mm	mm		
19	90	25	9.045 705
20	80	25	9.045 701
22	80	25	9.045 700
25	100	25	9.045 709
26	60	25	9.045 707
28	80	25	9.045 711
30	80	25	9.045 708
33	80	25	9.045 702
33	94	25	9.045 703
33	100	25	9.045 704
33	118	25	9.045 706
37	130	25	6.256 301
43	123	25	9.045 710

5



1

1 Gas washing bottle, PP

Graduated 250ml polypropylene cylinder with a stable extended base for use in precipitating elements from gas.

- Gas is dispersed through a removable fitting that has a coarse grade porosity, polyethylene dispersion disc
- Silicone stopper holds 6.3mm O.D. tubes for entrance and exit of gas
- 0.5 psi maximum pressure

Description	Capacity ml	Height mm	PK	Cat. No.
Gas washing bottle	250	273	1	9.110 290

2

2 3 Expansion and reduction adapters, borosilicate glass 3.3

Manufactured from borosilicate glass 3.3 which is resistant to heat and almost all chemicals. They meet the highest quality standards according to DIN 12257. They have excellent grinding to prevent airleaks. The bottom part of the ground joints are fire polished.

Cone	Socket	PK	Cat. No.
NS	NS		
19/26	14/23	1	6.243 581
24/29	14/23	1	6.243 582
29/32	14/23	1	9.011 740
14/23	19/26	1	4.008 341
24/29	19/26	1	4.008 342
29/32	19/26	1	4.008 343
29/32	24/29	1	6.241 533
14/23	29/32	1	6.235 966
19/26	29/32	1	4.008 344
24/29	29/32	1	4.008 345

3

4

4 Adapter for thermometer, borosilicate glass 3.3

Manufactured from borosilicate glass 3.3 according to DIN 12257 standard, ideal to use for thermometers with Ø 6 - 8 mm. Screw joint provides easy depth adjustment of thermometer. Seal material: NBR

Adapter bore diam. mm	Cone NS	Neck thread GL	PK	Cat. No.
6 - 8	14/23	14	1	4.008 360
6 - 8	29/32	14	1	6.244 589

5

5 NS-Glass stoppers, hollow borosilicate glass 3.3

Manufactured from borosilicate glass 3.3 which is resistant to heat and almost all chemicals. They meet the highest quality standards according to DIN 12252. Lower closed end of stopper features a "drip-tip" to ensure adhered liquid is returned to the flask. Hexagonal flat head prevents the stopper from rolling and allows stopper to be stood on end preventing contamination of the ground surface.

Description	NS	PK	Cat. No.
clear	10/19	1	7.900 483
clear	12/21	1	6.242 396
clear	14/23	1	9.229 990
clear	19/26	1	9.229 991
clear	24/29	1	6.240 333
clear	29/32	1	9.229 992
clear	34/35	1	6.240 060

1 Clips for joints, POM

Manufactured from POM and has excellent chemical resistance as well as a very good mechanical strength. They are perfect tools to join two ground joints.

Colour	NS	PK	Cat. No.
black	10/19	1	4.008 347
yellow	14/23	1	4.008 349
blue	19/26	1	4.008 350
green	24/29	1	4.008 351
red	29/32	1	4.008 352



2 Joint clips KECK, POM, for conical ground joints

Melting point 175 °C. Excellent chemical resistance. Rigid. Heat resistant up to 150 °C, sizes colour coded.

For	Colour	PK	Cat. No.
NS 14	yellow	1	9.011 775
NS 19	blue	1	9.011 776
NS 24	green	1	9.011 777
NS 29	red	1	9.011 778



3 Ground joint clips for sleeve connections, wire, Chrome-nickel steel

Chrome-nickel steel.

NS	PK	Cat. No.
14/23	1	9.011 705
19/26	1	9.011 706
24/29	1	9.011 707
29/32	1	9.011 708
45/40	1	9.011 710



4 LLG-Fork clamps for spherical joints

Made of stainless steel 304. For spherical ground joint connections. With set screw.

Size	PK	Cat. No.
S13	1	9.011 797
S19	1	9.011 798
S29	1	9.011 799
S35	1	9.011 800



1

1 Sleeves with ribs, PTFE

For use with ground glass joints. Suitable for vacuums up to 0.1mbar. Reusable and long lasting. The sealing ribs grip on the inside wall of the glass socket, sealing without the need for grease and enabling the cone to be freed easily when required.

NS	PK	Cat. No.
14/23	1	9.011 655
19/26	1	9.011 656
24/29	1	9.011 657
29/32	1	9.011 658
45/40	1	9.011 660

2

2 Sleeves, cone joint, PTFE

With knurled gripping ring at the top of the cone for easy removal. For gas, liquid and vacuum-tight cone joint connections with sizes as outlined below. Reusable. With reinforced external ribs for a high-vacuum tight seal (leakage rate: $< 1 \times 10^{-4}$ mbar x l x s⁻¹). No joint sealant or grease required.

NS	PK	Cat. No.
14/23	1	9.011 642
19/26	1	9.011 643
24/29	1	9.011 644
29/32	1	9.011 645
45/40	1	9.011 647

3

3 BUDDER - joint grease

For all glass joints. Transparent, vacuum tight, water washable and water soluble. Maintains practically the consistency between -30 °C and +200 °C, non-solidifying. Compatible with most elastomers. Tube of 80 g.

Weight g	PK	Cat. No.
80	1	9.116 950

4

Laboratory greases glisseal® N and glisseal® HV

Laboratory grease without silicone. For sealing and greasing ground and spherical glass joints, plastic and metal connections, as well as for solving the most demanding lubricating problems, e.g. in precision engineering and in the optical industry. Apply only a very thin layer. Glisseal® can be easily removed with Deconex® cleaners. 60 g tube.

Normal quality, with red cap:

Colour:	translucent
Dripping point:	without
Working temperature ranges:	
In air:	-40 to 200 °C
Under vacuum:	-40 to 300 °C
For short periods, up to:	350 °C

High vacuum quality, with blue cap:

Colour:	dark brown
Dripping point:	without
Working temperature range:	
In air:	-40 to 220 °C
Under vacuum:	-40 to 320 °C
For short periods, up to:	400 °C

5

Type	Description	Weight kg	PK	Cat. No.
glisseal® N	tube	0.06	1	9.116 934 4
glisseal® HV	tube	0.06	1	9.116 935 5

2 | 4 Mini centrifuges LLG-uniCFUGE 2 and LLG-uniCFUGE 2/5

A compact and reasonably priced mini centrifuge with two rotor types. Speed can be adjusted to 4000 rpm or 6000 rpm. Powerful motor for fast starting. Quick stop when the lid is opened.

LLG-uniCFUGE 2 with **Universal rotor** for 6 x 1.5/2.0 ml and 6 x 0.5 ml tubes and 2 times 8 x 0.2 ml PCR-strips.

LLG-uniCFUGE 2/5 with **rotor for 4 x 5 ml tubes**.

Specifications

Max. RCF:	1200 xg and 2000 xg
Max. speed:	4000 rpm and 6000 rpm
Max. load:	6 x 0.5/1.5/2 ml and 2 x 8-tube PCR strips (0.2 ml) // 4 x 5 ml tubes
Dimensions (diam. x H):	140 x 120 mm
Weight:	0.7 kg
Power supply:	100 - 240 V, 50/60 Hz, 1 A
Warranty:	3 years

Description	PK	Cat. No.
LLG-uniCFUGE 2 with universal rotor with EU-plug	1	6.263 510 1
LLG-uniCFUGE 2 with universal rotor with UK-plug	1	6.263 511
LLG-uniCFUGE 2/5 with rotor for 5 ml Tubes with EU-plug	1	6.263 515 3
LLG-uniCFUGE 2/5 with rotor for 5 ml Tubes with UK-plug	1	6.263 516

1



6.263 510

2



3



6.263 515

4



1 2 3 Mini centrifuge LLG-uniCFUGE 3 with timer and digital display

A compact and reasonably priced mini centrifuge with brushless and non-wearing high-efficiency motor. Stepless speed adjustment from 0 to 6000 rpm. Microprocessor controlled regulation for load-independent accuracy and integrated imbalance control. Integrated timer (0 - 25 minutes) and high speed constancy for reproducible results. Quick stop when the lid is opened. 2 flow-optimised rotors for 8 x 1.5/2 ml or 16 x 0.2 ml tubes reduce noise level and heat generation. Supplied with suction feet for a stable operation.

The following types of vessel can be used:

8 x 1.5 ml micro tubes
8 x 2 ml micro tubes
16 x 0.2 ml micro tubes

By using the fitting adapter:

8 x 0.4 ml micro tubes
8 x 0.5 ml micro tubes

Scope of delivery: Centrifuge, rotor for 8 x 1.5/2 ml tubes, rotor for 16 x 0.2 ml tubes, adapter for 8 x 0.2/0.4/0.5 ml tubes

Specifications

Max. RCF:	2000 xg
Max. speed:	variable up to 6000 rpm
Motor:	brushless DC motor
Max. load:	8 x 1.5/2 ml or 16 x 0.2 ml PCR tubes
Timer:	0 - 25 min, continuous
Dimensions (diam. x H):	160 x 116 mm
Weight:	1.1 kg
Power supply:	100 - 240 V, 50/60 Hz
Warranty:	3 years

Description	PK	Cat. No.
LLG-uniCFUGE 3 with EU-plug	1	6.263 520
LLG-uniCFUGE 3 with UK-plug	1	6.263 521



1 | 2 Mini centrifuge LLG-uniCFUGE 5 with timer and digital display

Compact microcentrifuge with excellent price-performance ratio and a performance of up to 15.595 xg. Microprocessor controlled brushless motor for speeds up to **15.000 rpm. Operation possible in RPM or RCF mode.** Short-spin mode with selectable RZB and RPM values. Fixed angle rotor with lid, made of aluminium for 12 x 1.5/2 ml tubes with optimised aerodynamics which minimize heat generation and noise during use. **Large LCD (3.9")** readout with intuitive and user-friendly interface. **Integrated imbalance-detection** with automatic shutdown. Wide suction feet provide a stable base. The centrifuge can be controlled via computer by using the included software that can store up to 99 user-defined programmes. Operational record output to Excel.

The following types of vessel can be used:

- 12 x 0.2 ml PCR-Tubes
- 12 x 0.4 ml Centrifuge tubes
- 12 x 0.5 ml Centrifuge tubes
- 12 x 1.5 ml Centrifuge tubes
- 12 x 2.0 ml Centrifuge tubes

Scope of delivery:

- Centrifuge with rotor (incl. lid) for 12 x 1.5/2 ml tubes
- Power supply with USB cable
- 12 Adapters for 0.4/0.5 ml tubes
- 12 Adapters for 0.2 ml tubes
- Allen wrench with T handle
- Software CD
- User manual

Optional:

- Rotor for 16 x 0.2 ml tubes or 2 x 8 PCR-strips (Cat. No. 6.263 535)

Specifications

Max. RCF:	15.595 xg
Max. speed:	variable from 500 up to 15.000 rpm
Motor:	brushless DC motor
Max. load:	12 x 2 ml PCR tubes
Timer:	0 - 999 min
Dimensions (W x D x H):	262 x 230 x 131 mm
Weight:	4 kg
Power supply:	100 - 240 V, 50/60 Hz
Warranty:	3 years

Type	PK	Cat. No.
LLG-uniCFUGE 5 with EU-plug	1	6.263 530
LLG-uniCFUGE 5 with UK-plug	1	6.263 531
Rotor for 16 x 0,2ml tubes or 2 x 8 PCR-strips	1	6.263 535

1



2





1 LLG-Microcentrifuge tubes, PP

LLG Microtubes cover standard volumes for a variety of sample tests. They are available in 0.5 ml, 1.5 ml and 2.0 ml volumes. These standard Microtubes withstand high centrifugal forces, are temperature and chemical-resistant and guaranteed leak free. An innovative and modern new generation of Microtubes with new features. Perfect sealing qualities, excellent chemical stability and optimal construction materials guarantee even better resistance to centrifugal and chemical forces. Easy to open and to close thanks to the improved lid geometry. For visual volume control the 1.5 ml tubes are equipped with graduations at 0.5 ml, 1.0 ml and 1.5 ml. The 2.0ml tubes have graduations at 0.5 ml, 1.0 ml, 1.5 ml and 2.0 ml. The 0.5 ml tubes have no graduations. Certified DNase-, RNase- and pyrogen free.

Clear, in bags. Certified free of DNase, RNase, suitable for microbiology. Guaranteed metal-free.

Specifications

Autoclavability

Temperature: 121 °C (250 °F)
 Pressure: 1.05 bar or 15 psi
 Time: 20 min or less

Centrifugation

Fixed angle rotor: 25000 x g
 Swing out rotor: 70000 x g

Form	Volume ml	PK	Cat. No.
conical	0.5	1000	9.409 023
conical	1.5	1000	9.409 024
round	2.0	1000	9.409 025



2 LLG-Centrifuge Tubes economy, PP

- With flat caps, PE
- With conical bottom (15 and 50 ml) or with self-standing bottom (50 ml).
- Easy-to-read black volume graduations
- With a large frosted writing area
- Engraved graduation at the conical bottom of each tube
- Max rotate speed up to 12.000 x g for conical bottom tubes and 6.000 x g for self-standing tubes
- Autoclavable at 121 °C and freezable to -80 °C
- Leak-proof
- DNase and RNAase free, aseptically
- Bulk packed

Form	Capacity ml	Height mm	PK	Cat. No.
conical	15	119.6	500	6.270 403
conical	50	113.9	500	6.270 404
with rim	50	116.5	500	6.270 405



3 LLG-Centrifuge tubes, PP

Polypropylene tubes with very good thermal, mechanical and chemical stability. With screw closures. Sterile tubes with screwed-on closure. Packed in boxes or bags. With graduations and labelling area.

Centrifugation capacity (Max. RCF): 6000 x g
 Height: 120 mm

Description	Form	Capacity ml	Diam. mm	PK	Cat. No.
sterile, single packed*	conical	15	17.0	50	9.316 062
big pack	conical	15	17.0	500	9.316 063
sterile, single packed*	conical	50	30.0	50	9.316 064
big pack	conical	50	30.0	500	9.316 065
aseptic, bulk pack	conical	50	30.0	50	6.263 887
sterile, single packed*	with rim	50	30.0	50	9.316 067
big pack, bulk pack	with rim	50	30.0	50	4.008 506

*Cytotoxicity-free, DNase/RNase- and human DNA-free.

Distillation, separation, filtration

Separating, centrifuging/Centrifuge tubes

1 2 3 LLG-Test and centrifuge tubes rimmed, PS or PP

- Made of ultra clear virgin polypropylene or virgin polystyrene
- Polystyrene tubes are transparent. Polypropylene tubes are opaque, break-resistant
- Tubes with cap are ethylene oxide sterilized
- With label

LLG-Dual-Position Caps for test- and centrifuge tubes, PE

- For culture tubes with an O.D. of 12 mm and 17 mm
- 2 locking positions possible
- Closed, but gas exchange is still possible for aerobic growth conditions
- Hermetically sealed for anaerobic growth conditions, for storage or despatch of samples or for centrifugation

Description	Capacity	Diam.	Height	Material	Max.	Max.	PK	Cat. No.
	ml	mm	mm		rcf	temp. °C		
with rim	4.0	12.0	75	PS	1400	80	500	6.265 657
with rim	4.0	12.0	75	PP	3000	120	500	6.265 658
with rim	12.0	17.0	100	PS	3000	80	250	6.265 659
with rim	12.0	17.0	100	PP	5500	120	250	6.265 660
with dual-position-cap, sterilized	4.0	12.0	75	PS	1400	80	500	6.265 661
with dual-position-cap, sterilized	4.0	12.0	75	PP	3000	120	500	6.265 662
with dual-position-cap, sterilized	12.0	17.0	100	PS	3000	80	500	6.265 663
with dual-position-cap, sterilized	12.0	17.0	100	PP	5500	120	500	6.265 664
dual-position-cap		12.0		PE	-		1000	6.265 665
dual-position-cap		17.0		PE	-		1000	6.265 666



LLG-Filter paper, qualitative grades

Made from 100 % cellulose.
Ash content 0.06 %.
Filtration speed according to DIN 53137.
Capacity of separation according to DIN 53135.



1 LLG-Qualitative filter paper, circles

Very fast, pore size 12 to 15 µm
- for coarse and voluminous precipitates like hydroxides and sulphides

Diam. mm	Filtration time secs.	PK	Cat. No.
90	10	100	9.045 830
110	10	100	9.045 831
125	10	100	9.045 832
150	10	100	9.045 833
185	10	100	9.045 834



2 LLG-Qualitative filter paper, circles

Medium fast, pore size 5 to 8 µm or 5 to 13 µm
- for fast filtration with fine particles

Diam. mm	Filtration time secs.	Pore size µm	PK	Cat. No.
42.5	50	5 - 8	100	9.045 820
90.0	50	5 - 8	100	9.045 821
110.0	50	5 - 8	100	9.045 822
125.0	50	5 - 8	100	7.970 266
150.0	50	5 - 8	100	7.970 269
185.0	50	5 - 8	100	6.242 668
240.0	50	5 - 8	100	6.242 631
42.5	88	5 - 13	100	9.045 800
47.0	88	5 - 13	100	9.045 801
55.0	88	5 - 13	100	9.045 802
70.0	88	5 - 13	100	9.045 803
90.0	88	5 - 13	100	9.045 804
110.0	88	5 - 13	100	9.045 805
125.0	88	5 - 13	100	9.045 806
150.0	88	5 - 13	100	9.045 807
185.0	88	5 - 13	100	9.045 808
240.0	88	5 - 13	100	9.045 809



3 LLG-Qualitative filter paper, folded filters

Medium fast, pore size 5 to 8 µm.
- for fast filtration with fine particles

Diam. mm	Filtration time secs.	PK	Cat. No.
70.0	50	100	7.659 027
125.0	50	100	9.045 825
150.0	50	100	9.045 826
185.0	50	100	9.045 827
240.0	50	100	6.242 632



4 LLG-Qualitative filter paper, circles

Slow, pore size 2 to 3 µm.
- for BaSO₄, SnO₄, CuO, Cu₂O

Diam. mm	Filtration time secs.	PK	Cat. No.
70.0	180	100	7.970 267
90.0	180	100	7.970 268
110.0	180	100	6.242 672
125.0	180	100	7.970 134
150.0	180	100	7.970 139
185.0	180	100	6.242 671



5 LLG-Qualitative filter paper, sheets

Medium fast, pore size 5 to 13 µm.
- for analytical works in laboratories

Dimensions mm	Filtration time secs.	PK	Cat. No.
460 x 570	88	100	9.045 810

LLG-Filter papers for quantitative analysis

Made from 100 % cellulose.

Ash content 0.007 %.

Filtration speed according to DIN 53137.

Capacity of separation according to DIN 53135.

1 LLG-Quantitative filter paper, circles

Fast, pore size 12 to 15µm

- for coarse, high volume precipitates
- for determinations according to the German Standard Methods for the examination of water, waste water and sludge.
- for $\text{Fe}(\text{OH})_2$, $\text{Al}(\text{OH})_3$, NaSO_4
- ashless, equivalent black tape

Diam. mm	Filtration time secs.	PK	Cat. No.
70	10	100	9.045 840
90	10	100	9.045 841
110	10	100	9.045 842
125	10	100	9.045 843
150	10	100	9.045 844
185	10	100	9.045 845

1



2 LLG-Quantitative filter paper, circles

Medium fast/fast, pore size 8 to 12 µm.

- most frequently used quantitative filter
- for PbS , Ag_2S , FeS , carbonates
- ashless, equivalent white tape

Diam. mm	Filtration time secs.	PK	Cat. No.
90	20	100	7.970 057
110	20	100	7.970 000
125	20	100	7.970 058
150	20	100	7.970 001
185	20	100	7.970 002
200	20	100	6.242 179

2



3 LLG-Quantitative filter paper, circles

Medium fast, pore size 5 to 8 µm.

- for NH_4MgPO_4 , CaC_2O_4 , BaSO_4
- ashless, equivalent red tape

Diam. mm	Filtration time secs.	PK	Cat. No.
55	50	100	6.256 437
70	50	100	7.970 571
90	50	100	7.970 032
110	50	100	6.242 748
125	50	100	7.970 045
150	50	100	6.252 765
185	50	100	6.242 747
240	50	100	7.970 591

3



4 LLG-Quantitative filter paper, circles

Slow, pore size 2 to 3 µm.

- for very fine precipitates and small particles
- for soil analysis
- for BaSO_4 (hot precipitate), PbSO_4 , Cu_2O , ZnS , NiS
- ashless, equivalent blue tape

Diam. mm	Filtration time secs.	PK	Cat. No.
70	180	100	7.970 271
90	180	100	9.045 850
110	180	100	6.242 670
125	180	100	9.045 851
150	180	100	9.045 852
185	180	100	6.242 669

4



Filtration/Syringe filters

1

1 LLG-Glass microfibre filters, filter circles

Diam. mm	Pore size µm	Filtration time secs.	Weight g / m ²	Thickness mm	PK	Cat. No.
47	1.60	60	52	0.26	100	9.045 861
55	1.60	60	52	0.26	100	6.242 633
90	1.60	60	52	0.26	100	6.252 072
110	1.60	60	52	0.26	100	7.970 339
125	1.60	60	52	0.26	100	7.970 033
150	1.60	60	52	0.26	100	9.045 862
47	1.20	100	52	0.26	100	6.243 711
55	1.20	100	52	0.26	100	6.251 383
70	1.20	100	52	0.26	100	9.045 866
90	1.20	100	52	0.26	100	9.045 867
110	1.20	100	52	0.26	100	9.045 868
47	0.70	310	75	0.45	100	7.970 106
55	0.70	310	75	0.45	100	7.970 742
70	0.70	310	75	0.45	100	6.253 553

Filtration velocity according to Herzberg

2

2 LLG-Syringe Filters SPHEROS

Cost-efficient syringe filters for filtration of a broad variety of solvents and aqueous or inorganic solutions. These syringe filters cover most applications in HPLC, pharmaceutical, environmental, biotechnology and food and beverage testing laboratories.

- Robust housing made of Polypropylene
- Multifunctional syringe filters with female Luer-Lock inlet and male Luer-Slip outlet
- Suitable for all syringes with Luer connection
- Sterile or non-sterile
- Sterile products in individual hard blister packaging and dispenser box

3

3 4 LLG Syringe Filters SPHEROS, Cellulose Acetate

Hydrophilic membrane for filtration of aqueous liquids. Low protein binding capacity. Especially suitable for biological macromolecules, water soluble oligomers and polymers. With female Luer-Lock inlet and male Luer-Slip outlet. Sterile products in individual hard blister packaging and dispenser box.

Filter diam. mm	Pore size µm	Housing	Sterile	PK	Cat. No.
13	0.22	PP, red	-	100	6.272 802
13	0.45	PP, red	-	100	6.272 803
25	0.22	PP, red	-	50	6.272 804
25	0.45	PP, red	-	50	6.272 805
13	0.22	PP, red	+	100	6.272 806
13	0.45	PP, red	+	100	6.272 807
25	0.22	PP, red	+	45	6.272 808
25	0.45	PP, red	+	45	6.272 809

4

5

5 LLG Syringe Filters SPHEROS, Nylon

Hydrophilic membrane for filtration of aqueous and organic/aqueous liquids with medium polarity. Very good chemical resistance to esters, alkaline solutions and alcohols. With female Luer-Lock inlet and male Luer-Slip outlet.

Filter diam. mm	Pore size µm	Housing	Sterile	PK	Cat. No.
13	0.22	PP, pink	-	100	6.272 810
13	0.45	PP, pink	-	100	6.272 811
25	0.22	PP, pink	-	50	6.272 812
25	0.45	PP, pink	-	50	6.272 813

6

6 LLG Syringe Filters SPHEROS, PTFE

Hydrophobic membrane for filtration of non-polar liquids and gases. Very good chemical resistance to all kinds of solvents and alkaline solutions. With female Luer-Lock inlet and male Luer-Slip outlet.

Filter diam. mm	Pore size µm	Housing	Sterile	PK	Cat. No.
13	0.22	PP, white	-	100	6.272 816
13	0.45	PP, white	-	100	6.272 817
25	0.22	PP, white	-	50	6.272 818
25	0.45	PP, white	-	50	6.272 819

LLG-Syringe Filters

We offer a line of syringe filters especially designed to provide efficient filtration of a broad variety of fluids, solvents, aqueous or inorganic solutions. Our syringe filters cover most applications in HPLC, pharmaceutical, environmental, biotechnology and food and beverage testing laboratories.

- Housing injected in Polypropylene or MABS
- Multifunctional Syringe filters equipped with Luer-Lock connections on both sides or female Luer-Lock input and male Luer-Slip output
- Suitable for all syringes with Luer connection
- Pre-sterilised or non-sterile
- Sterile products in individual hard blister
- Superior pressure stability

LLG Syringe Filter RC, Regenerated cellulose

Hydrophilic membrane features very low adsorption. It is recommended for filtration of aqueous and organic/aqueous liquids. For filtration of polar and medium polar liquids. With Luer-Lock input and Luer-Slip output.

Type	Filter diam.	Pore size	Housing	PK	Cat. No.
	mm	µm			
non sterile	13	0.20	PP	500	9.055 530 1
non sterile	13	0.45	PP	500	9.055 532
non sterile	25	0.20	PP	500	9.055 531
non sterile	25	0.45	PP	500	9.055 533

1



9.055 530

LLG Syringe Filter PES, Polyethersulfone

Hydrophobic membrane. Ideal for filtration of non-polar liquids and gases. It is very resistant to various solvents as well as acids and bases. With Luer-Lock input and Luer-Slip output.

Type	Filter diam.	Pore size	Housing	PK	Cat. No.
	mm	µm			
non sterile	25	0.20	PP	500	9.055 525
non sterile	25	0.45	PP	500	7.970 213 2
sterile	25	0.20	Acrylic	50	6.285 700
sterile	25	0.45	Acrylic	50	6.285 701

2



7.970 213

LLG Syringe Filter PVDF, Polyvinylidene fluoride

Hydrophilic membrane for aqueous polar and light unpolar solutions. Very low protein binding. High flow rates ideal for use with biological macromolecules, water soluble oligomers and polymers. With Luer-Lock input and Luer-Slip output.

Type	Filter diam.	Pore size	Housing	PK	Cat. No.
	mm	µm			
non sterile	25	0.20	PP	500	7.970 387
non sterile	25	0.45	PP	500	7.970 286 3

3



7.970 286

4 LLG-Inline-filters

The 50 mm inline filter with its ultra pure Polypropylene housing (ultrasonic welded) is designed to contain 47 mm membranes. The filter comes with 6-12 mm hose connectors (tapered) at the inlet and the outlet side. The PTFE-membrane can be used for filtration of aggressive chemicals including acids and non-aqueous solutions. Due to its high filter area of 1735 mm² the filter is suitable for long term gas filtration /venting applications, it could be used for filtration of higher volumes of liquid (up to approximately 500 ml, depending on the particle load of the filtrated suspension) or for filtration of aggressive non aqueous liquids.

- hydrophobic PTFE-membrane
- housing polypropylene
- autoclavable at 121 °C for 20 minutes at 2 bar, max. 3 cycles
- stepped hose connector of 6-10 mm on either sides
- high throughput with low pressure drop
- max. operating pressure 4.0 bar

Diam.	Pore size	PK	Cat. No.
mm	µm		
50	0.20	5	9.059 513
50	0.45	5	9.059 514

4



1

1 Filter crucibles, borosilicate glass 3.3

Borosilicate glass 3.3. With sintered disc filter as outlined below.

Capacity ml	Diam. mm	Porosity	PK	Cat. No.
30	30	2	1	9.052 037
30	30	3	1	9.052 038
30	30	4	1	9.052 039
30	30	5	1	9.052 040
50	40	1	1	9.052 041
50	40	2	1	9.052 042
50	40	3	1	9.052 043
50	40	4	1	9.052 044
50	40	5	1	9.052 065

2

2 Filter funnels, Borosilicate glass 3.3

Borosilicate glass 3.3, with sintered disc filter as outlined below. Autoclavable.

Capacity ml	Diam. mm	Stem diam. mm	Porosity	PK	Cat. No.
50	36	10	1	1	9.052 367
50	36	10	2	1	9.052 368
50	36	10	3	1	9.052 369
50	36	10	4	1	9.052 370
75	48	10	1	1	9.052 371
75	48	10	2	1	9.052 372
75	48	10	3	1	9.052 373
75	48	10	4	1	9.052 374
125	60	10	1	1	9.052 375
125	60	10	2	1	9.052 376
125	60	10	3	1	9.052 377
125	60	10	4	1	9.052 378
250	80	18	1	1	9.052 066
250	80	18	2	1	9.052 067
250	80	18	3	1	9.052 068
250	80	18	4	1	9.052 069
500	95	22	1	1	9.052 379
500	95	22	2	1	9.052 380
500	95	22	3	1	9.052 381
500	95	22	4	1	9.052 382

3 LLG Buchner funnels, porcelain

For filterpaper diam. mm	Capacity ml	PK	Cat. No.
45	35	1	6.239 903
55	70	1	6.237 328
70	120	1	6.231 541
90	240	1	9.252 500
110	400	1	9.252 501
125	600	1	9.252 502
150	1000	1	9.252 503
185	2000	1	9.252 504

3

1 Rubber Spacers (GuKo), natural rubber

Grey, filter gaskets made of natural rubber (NR). Conical, to fit filter funnels or crucibles into suction flasks.

Top diam. mm	Bottom diam. mm	Height mm	Wall thickness mm	PK	Cat. No.
21	12.0	18	2.5	1	9.052 412
27	17.0	20	3.0	1	9.052 417
33	21.0	24	3.0	1	9.052 423
41	27.5	27	4.0	1	9.052 427
53	33.0	34	5.0	1	9.052 432
68	48.0	35	5.5	1	9.052 436
78	58.0	35	6.0	1	9.052 439
89	66.0	40	6.5	1	9.052 443



2 Filter flasks, Erlenmeyer shape, borosilicate glass 3.3

Borosilicate glass 3.3 with thick walls according to ISO 6556 and DIN 12475 standards. The glass side arm or the Polypropylene side arm is suitable to work with 6 mm to 10 mm hose diameters. The Polypropylene side arm has a screw thread connector for easy and safe fitting of the tubing.

Capacity ml	lateral connection	PK	Cat. No.
100	glass	1	4.008 437
250	glass	1	6.241 652
500	glass	1	6.241 291
1000	glass	1	6.239 008
2000	glass	1	4.008 438
100	PP	1	4.008 439
250	PP	1	6.237 706
500	PP	1	6.237 707
1000	PP	1	6.237 708
2000	PP	1	6.242 170



Cooling/Cryogenic tubes-Cryogenic boxes

1

1 LLG-Cryotubes, PP, sterile

With star-shape in the screw cap, for automated capper/decapper.

Temperature resistant down to -196 °C. **Not appropriate for operations in liquid nitrogen.**

With marking area, fill line and graduations printed on the vial. Safe and precise handling of biotechnology materials.

Bar-code printed on each tube. DNase/RNase free. Vials and caps are autoclavable at 121 °C.

Homogeneous conception:

- all made from polypropylene

- single-body, single-turn screw cap

Printed graduations for accurate measurements. Large white area for writing specimen identification. Sterile.

Packed in 2 bags of 50 tubes.

Description	Capacity ml	Ext. diam. mm	Height mm	Thread	PK	Cat. No.
self-standing	1.2	12.6	40.2	external	100	9.401 160
self-standing	1.2	12.6	40.2	internal	100	9.401 161
self-standing	2.0	12.6	45.6	external	100	9.401 162
self-standing	2.0	12.6	48.2	internal	100	9.401 163
without ring	2.0	12.6	44.5	external	100	9.401 164
without ring	2.0	12.6	47.0	internal	100	9.401 165
self-standing	5.0	12.6	87.6	external	100	9.401 166
without ring	5.0	12.6	89.2	internal	100	9.401 167
self-standing	5.0	12.6	90.3	internal	100	9.401 168

Fits in 10 x 10 Cryobox System 100™ 5026, Order No: 9.400 927

2

2 Insert cap discs for LLG cryotubes, PP

Cap-disc with star-shaped insert. For colour-coding of cryotubes and quick identification of the samples.

Colour	PK	Cat. No.
blue	1000	9.401 170
white	1000	9.401 171
yellow	1000	9.401 172
pink	1000	9.401 173
red	1000	9.401 174
green	1000	9.401 175

3

3 LLG-Cryogenic storage boxes, plastic coated, 136 x 136

Freezer and cryogenic storage boxes (CryoBoxes). Made of cardboard, **plastic coated** without divider.

Dimensions: 136 x 136 mm square. For the storage of samples. With lid.

Further colours available on request.

Colour	Int. height mm	PK	Cat. No.
white	32	1	4.653 682
white	50	1	6.080 130
yellow	50	1	6.077 876
blue	50	1	6.077 875
green	50	1	6.081 021
red	50	1	6.081 022
white	75	1	6.802 726
blue	75	1	6.260 006
red	75	1	6.260 007
green	75	1	6.260 008
yellow	75	1	6.260 009
white	100	1	6.237 840
blue	100	1	6.260 010
red	100	1	6.260 011
green	100	1	6.260 012
white	130	1	6.083 519
blue	130	1	4.654 548
red	130	1	4.654 549

1 LLG-Partition inserts for Cryoboxes, 136 x 136

For cryoboxes 136 x 136 mm. With compartment heights and formats as indicated. Other sizes available on request.



Height mm	Array	For tubes diam. mm	PK	Cat. No.
22	7 x 7	ca. 17.9	1	4.654 558
22	8 x 8	ca. 15.7	1	4.654 557
22	9 x 9	ca. 13.9	1	4.654 556
22	10 x 10	ca. 12.5	1	4.654 555
40	9 x 9	ca. 13.9	1	9.405 872
22	12 x 12	ca. 10.2	1	4.654 554
22	13 x 13	ca. 9.4	1	4.654 553
22	14 x 14	ca. 8.7	1	4.654 552
22	16 x 16	ca. 7.5	1	6.257 202
30	4 x 4	ca. 32.0	1	6.305 840
30	5 x 5	ca. 25.5	1	9.401 055
30	6 x 6	ca. 21.0	1	6.090 419
30	7 x 7	ca. 17.9	1	7.617 877
30	8 x 8	ca. 15.7	1	6.243 752
30	9 x 9	ca. 13.9	1	9.405 871
30	10 x 10	ca. 12.5	1	9.405 875
30	12 x 12	ca. 10.2	1	9.401 050
30	13 x 13	ca. 9.4	1	6.228 893
30	14 x 14	ca. 8.7	1	6.260 016
30	16 x 16	ca. 7.5	1	9.405 883
40	4 x 4	ca. 32.0	1	6.401 505
40	5 x 5	ca. 25.5	1	6.260 020
40	6 x 6	ca. 21.0	1	6.202 839
40	7 x 7	ca. 17.9	1	6.802 215
40	8 x 8	ca. 15.7	1	6.900 361
40	10 x 10	ca. 12.5	1	9.405 876
40	12 x 12	ca. 10.2	1	9.405 880
65	6 x 6	ca. 21.0	1	6.201 071
65	8 x 8	ca. 15.7	1	6.801 789
65	9 x 9	ca. 13.9	1	9.405 873
65	10 x 10	ca. 12.5	1	9.405 877
65	4 x 4	ca. 32.0	1	9.405 870
65	5 x 5	ca. 25.5	1	6.079 677

2 LLG-Cryogenic storage boxes, plastic coated, 133 x 133

Made of cardboard, **plastic coated**. Without divider. Dimensions: 133 x 133 mm square. For the storage of samples. With lid. Further sizes and colours available on request.



Colour	Int. height mm	PK	Cat. No.
white	32	1	6.260 029
red	32	1	6.234 735
green	32	1	4.654 505
blue	32	1	6.802 431
white	50	1	6.082 701
red	50	1	6.081 654
green	50	1	6.084 538
yellow	50	1	6.260 091
blue	50	1	6.700 568
white	75	1	6.801 707
yellow	75	1	6.260 031
green	75	1	6.803 056
blue	75	1	9.698 776
white	100	1	6.260 032
red	100	1	9.698 787
yellow	100	1	9.698 789
blue	100	1	9.698 786
green	100	1	9.698 788
white	130	1	6.260 033
green	130	1	4.654 509

Cooling/Cryogenic boxes

1

1 LLG Partition inserts for Cryoboxes, 133 x 133

For cryoboxes 133 x 133 mm. With compartment heights and formats as indicated. Other sizes available on request.

Height	Array	For tubes diam.	PK	Cat. No.
mm		mm		
22	8 x 8	ca. 15.0	1	4.654 512
22	9 x 9	ca. 13.0	1	6.265 799
22	10 x 10	ca. 12.0	1	6.265 800
22	12 x 12	ca. 9.8	1	4.653 626
30	4 x 4	ca. 30.8	1	6.260 038
30	5 x 5	ca. 24.5	1	7.606 811
30	6 x 6	ca. 20.3	1	6.265 798
30	7 x 7	ca. 17.3	1	9.698 773
30	8 x 8	ca. 15.0	1	9.698 772
30	9 x 9	ca. 13.0	1	6.081 879
30	10 x 10	ca. 12.0	1	6.075 820
30	12 x 12	ca. 9.8	1	6.260 035
40	5 x 5	ca. 24.5	1	6.260 044
40	6 x 6	ca. 20.3	1	6.260 043
40	7 x 7	ca. 17.3	1	9.698 783
40	8 x 8	ca. 15.0	1	9.698 782
40	9 x 9	ca. 13.0	1	9.698 781
40	10 x 10	ca. 12.0	1	9.698 780
65	4 x 4	ca. 30.8	1	6.079 079
65	5 x 5	ca. 24.5	1	6.260 046
65	6 x 6	ca. 20.3	1	6.206 129
65	7 x 7	ca. 17.3	1	9.698 793
65	8 x 8	ca. 15.0	1	9.698 792
65	9 x 9	ca. 13.0	1	9.698 791
65	10 x 10	ca. 12.0	1	9.698 790

2

2 Cryobox for 5ml centrifuge tubes with partition insert, white, 133 x 133

Water repellent high quality and recyclable carton. With partition inserts for up to 25 x 5 ml centrifuge tubes.

Description	Array	Int. height	PK	Cat. No.
		mm		
Cryobox	5 x 5	75	1	6.281 179

3

3 LLG-Cryogenic storage boxes, PP, autoclavable

With 81 places, 9 x 9 grid and numerical coded. Robust hinge with safe snap-on lid, stackable for safe transport. Minimised liquid retention. Guaranteed metal free. Temperature resistant from -90 °C - +121 °C, autoclavable at 121 °C, opened, 20 minutes. Dimensions: 133 x 133 x 52 mm

Colour	Array	PK	Cat. No.
Magenta/clear	9 x 9	1	9.405 800

4

4 Cryogenic boxes, 81 well, PP, autoclavable

The boxes are made of polypropylene and can be used in temperatures as low as -90 °C. The boxes are autoclavable at +121 °C for 20 minutes. The boxes have a fixed grid divider with 9x9 cells and are suited for 1.2 ml and 2 ml cryogenic vials. Cellcodes are printed on the lid for easy identification.

Type	Dimensions (l x w x h) mm	PK	Cat. No.
Blue	130 x 130 x 50	1	9.698 708
Green	130 x 130 x 50	1	9.698 709
Natural	130 x 130 x 50	1	9.698 710
Red	130 x 130 x 50	1	9.698 711
Yellow	130 x 130 x 50	1	9.698 712

1 Cryogenic boxes, PP, 81 well, autoclavable

Polypropylene box fits in standard freezer racks. Tubes are easily located with moulded grid lines and a moulded reference point on the lid. Stores 1.5 ml to 2.0 ml microtubes under easy-open, friction-fit lid. Dimensions: 130 mm x 130 mm x 47 mm. Autoclavable.

Colour	PK	Cat. No.
natural	1	9.193 983
blue	1	7.078 821
green	1	7.058 103
pink	1	7.058 102
yellow	1	7.078 822
orange	1	7.083 522
blue, green, pink, yellow, orange	5	9.193 984



2 Microtube Storage Boxes, PP, 50-/100-Well

Autoclavable. Compact storage box has angled front slot for easy access to tubes. Rugged, polypropylene box has durable three-point hinges, snapping clasp for secure closure, moulded grid lines on lid, imprinted coordinates on bottom of base and imprinted and raised coordinates on tube wells. Ideal for sample or case study storage. Holds 1.5 ml to 2.0 ml microtubes. Resist storage temperatures from -80 to +121 °C.

Colour	Dimensions (l x w x h) mm	Array	PK	Cat. No.
blue, green, purple, yellow, orange	141 x 92 x 56	50	5	9.193 985
natural	141 x 92 x 56	50	1	6.243 162
blue, green, purple, yellow, orange	141 x 151 x 57	100	5	9.193 981
natural	141 x 151 x 57	100	1	6.206 710



LLG-Temperature block exact, aluminium

Suitable for both cooling and heating, universally usable, uniform temperature distribution within the block, ideal for all temperature-sensitive applications.

Aluminium blocks with conical compartments and closed bottom for easy and precise tempering of reaction tubes and PCR tubes. The precisely adapted shape of the borings and the closed bottom offer advantages compared with cylindrical drilled blocks with open bottom, such as much better heat transfer and temperature accuracy. Made of a special aluminium alloy with high thermal conductivity. Identical temperature conditions for all samples. Compact size, requiring little space. Suitable for 96-well plates, 8 or 12 strips and single tubes. Ideal for working with 8- or 12-channel pipettes. Blocks for different tube sizes and combinations of tube sizes as indicated, all working steps in one block, holes closed at the bottom and tapered to fit perfectly the respective tube sizes and offer an optimum heat exchange.

Array	PK	Cat. No.
96 x 0.2 ml PCR tubes + 6 x 1.5 ml tubes	1	9.409 015
36 x 0.5 ml tubes + 11 x 1.5 ml tubes	1	9.409 016
24 x 1.5 ml tubes	1	9.409 017
24 x 2.0 ml tubes	1	9.409 018
25 x 2.0 ml Cryogenic tubes with round bottom	1	9.409 006
12 x 15.0 ml Centrifuge tubes	1	9.409 008



9.409 015



9.409 017

5 LLG-Temperature block exact, aluminium, for crogenic tubes with rim, single-handed operation

Simultaneous single-handed operation and cooling of cryogenic vials

The cryogenic tubes are fixed in the cavities with a pin so that they can be opened and closed with one hand. Suitable for most cryogenic tubes with rim or notch such as LLG Labware. Cryogenic tubes are cooled by uniform temperature distribution in the block, ideal for temperature-critical work. The closed bottom of the block provides a much better temperature distribution and temperature accuracy over the block compared to blocks with open bottom. Made of a special aluminum alloy with high thermal conductivity. Thus, the block has identical temperature conditions for all samples. For 25 x 2.0 ml Cryogenic tubes with tripod rim.

Description	PK	Cat. No.
LLG-Temperature block exact, aluminium	1	9.409 007



1

1 Floating Tube Racks, PE

Polyethylene foam. Resist water absorption so racks can be washed and reused. Ideal for floating tubes in water baths, tubs, or beakers. Racks include detachable carrying handles, to easily lift samples out of baths.

Type	For tubes ml	Colour	Array	PK	Cat. No.
Diamond	50	green	4	5	6.238 546
Parallelogram	15	blue	8	5	6.238 547
Rectangle	1.5 to 2.0	yellow	24	5	6.238 545
Round	0.2/0.5/1.5 to 2	blue	18	5	6.240 378

2

2 Cool Containers True North®, PU

Rigid polyurethane container provides durability for chilling your temperature sensitive samples. Excellent insulation properties for ultra cold. Use with ice, dry ice and ice-salt slurries, etc. For low temperature use down to -196 °C. Minimize evaporation loss with close fit lid. Easily remove with comfortable recessed knobs. Keyed lid and base fit together to conveniently store lid under base. With spout and ergonomic handles for safe handling. Stackable.

Colour	Capacity	Dimensions (l x w x h) l mm	PK	Cat. No.
black	4	234 x 181*	1	9.010 691
green	1	267 x 195.5 x 114	1	9.010 692
blue	4	381 x 254 x 182	1	9.010 693
red	9	521 x 292 x 163	1	9.010 694

*(diam. x H)

3

3 LLG- Floating pellets, PP

Pellets with 20 mm diameter. Can cover 0.1 m². Protect against evaporation and fast temperature loss. Decrease hazardous vapors. Resistant against most acids, bases, solvents and mineral oils. Temperature stable up to +100 °C.

Description	PK	Cat. No.
Floating pellets	250	6.266 611

4

4 LLG-Laboratory Power Failure Detector

- Alarm is reported immediately visually and acoustically
- Reports alarm even for short power outages or for a period of at least 12 hours (can be switched off manually)
- Plug safety cover offers protection against accidentally pulling the plug
- Maximum total power of connected devices. 3500 W power supply 230 V 50 Hz
- Suitable for European plugs
- Max. Rating 16 A
- With built-in battery

Scope of supply:

- 1 x power failure detector
- 2 x plug safety caps
- 2 x screws

Type	PK	Cat. No.
LLG-Laboratory Power Failure Detector	1	6.255 819

1 Heating bath liquid, BUDE

1

Use:

BUDE heating bath liquid can be used continuously as a heating medium up to approx. 170 °C. Higher temperatures (below flash point) are possible, but will result in rapid darkening. The low pour point allows the bath liquid also to be used as a cooling medium. Mixtures with 10 % to 30 % water achieve best results.

The crucial advantages of BUDE heating bath liquid compared to the oils or other organic liquid mainly used are:

- accidental spillage of water into the bath does not lead to dangerous spitting at temperatures over 100 °C, as the water dissolves in the heating bath liquid and subsequently evaporates safely
- BUDE heating bath liquid can easily be rinsed away with water which eases cleaning of laboratory equipment, e.g. distillation flasks, and also bench or floor if the bath liquid is accidentally spilled.
- BUDE heating bath liquid does not foam when mixed with water.

Viscosity on addition of water:

BUDE heating bath liquid is quite viscous at ambient or low temperatures, and therefore sometimes difficult to dispense. The addition of 10-20 % water reduces the viscosity and enables easier handling. If the mixture is then heated to 100 °C, the water evaporates without boiling. Further heating is only shortly delayed by this. Before next heating, water can be added again.

Water solubility: BUDE heating bath liquid can be mixed with water in any ratio. The hardness of the water has no effect on the bath liquid.

Chemical character:

Modified polyglycoether

Appearance:

Clear, colourless or lightly yellowish liquid

Storage time:

When stored for long periods (over 2 years) the product may become darker. This does not affect the performance of the product.

Water solubility:

Heating bath liquid BUDE can be mixed with water in any ratio.

pH value (DIN ISO 976):

6-8 (100 g/l, 20 °C)

Solidification temperature (DIN ISO 3016):

approx. -39 °C

Boiling point:

200 °C

Density (DIN 51757, 23 °C):

approx. 1.13 g/cm³ to 1.17 g/cm³

Flashpoint (DIN EN ISO 2592):

> 290 °C

Ignition temperature (DIN 51794):

approx. 390 °C



Container	PK	Cat. No.
5 litres	1	9.906 200



3 Universal drying oven LLG-uniOVEN 42 and LLG-uniOVEN 110

Microprocessor controlled universal drying oven with **forced convection** including two shelves.

- Quick and intuitive operation
- Microprocessor control with integrated auto-diagnostic system
- Forced convection with fan
- Digital display for time and temperature
- **Timer:** 1 minute to 99.9 h and continuous
- Delayed start timer: 1 minute to 99.9 h
- Outlet for vapour exhaustion
- Acoustical and visible information for end of program
- Acoustical and optical alarm at temperature differences
- Interior made of stainless steel
- Adjustable over temperature protection at 300 °C

Scope of delivery: LLG-uniOVEN incl. 2 shelves

Specifications

Internal volume:	42 l or 110 l
Temperature range:	RT +7 up to 250 °C
Ambient temperature:	+5 up to +40 °C
Temperature accuracy:	±1 °C (at 70 °C)
Temperature uniformity:	±2 °C (at 70 °C)
Ambient humidity:	80 %, non-condensing
Power supply:	230 V, 50/60 Hz
Warranty:	3 years

Type	Internal volume	External dimensions (W x D x H) mm	Internal dimensions (W x D x H) mm	Power consumption	Weight	PK	Cat. No.
	litres			W	kg		
LLG-uniOVEN 42 with EU-plug	42	705 x 505 x 540	420 x 280 x 360	850	39	1	6.263 670 1
LLG-uniOVEN 42 with UK-plug	42	705 x 505 x 540	420 x 280 x 360	850	38	1	6.263 673
LLG-uniOVEN 110 with EU-plug	110	790 x 665 x 680	500 x 445 x 500	1550	66	1	6.263 675 2
LLG-uniOVEN 110 with UK-plug	110	790 x 665 x 680	500 x 445 x 500	1550	66	1	6.263 678

1

6.263 670

2

6.263 675

3

1 2 Universal drying oven LLG-uniOVEN 150

Microprocessor controlled universal drying oven with forced convection including two shelves.

- Quick and intuitive operation
- Microprocessor control with integrated auto-diagnostic system
- 2 PT 100 sensors for precise temperature control
- 5 different programs with 5 steps **can be programmed** by the user
- Controller can be **protected by password**
- **Lockable door handle**
- LED display
- Interior made of stainless steel (AISI-304)
- Fan speed adjustable
- Hot indicator for temperatures above 50 °C
- Adjustable over temperature protection

Scope of delivery: LLG-uniOVEN 150 incl. 2 shelves

Specifications

Internal volume:	150 l
Ambient temperature:	RT +10 °C up to 300 °C.
Working temperature:	+5 °C up to +35 °C
Temperature accuracy:	±0.5 °C (at 70 °C)
Temperature uniformity:	±2 °C (at 70 °C)
Ambient humidity:	80 %, non-condensing
Power supply:	230 V, 50/60 Hz
Warranty:	3 years

Type	Internal volume	External dimensions (W x D x H) mm	Internal dimensions (W x D x H) mm	Power consumption	Weight	PK	Cat. No.
	litres			W	kg		
LLG-uniOVEN 150 with EU-plug	150	700 x 665 x 1010	495 x 440 x 705	3000	85	1	6.263 680
LLG-uniOVEN 150 with UK-plug	150	700 x 665 x 1010	495 x 440 x 705	3000	85	1	6.263 682

1



2



Accessories for Universal drying ovens LLG-uniOVEN 42/110/150

Description	PK	Cat. No.
Shelf for LLG-uniOVEN 110	1	6.263 676
Shelf carrier for LLG-uniOVEN 110	2	6.263 677
Shelf for incl. 2 shelf holders LLG-uniOVEN 150	1	6.263 681

1 2 Mini-Incubator LLG-uni^{INC}U 20

The **portable** LLG-uni^{INC}U 20 **digital** incubator is ideally suited for haematology and microbiology applications, such as the cultivation of contact plates for microbiological hygiene analysis. Due to its small footprint and economical price, it is also the perfect incubator for educational institutions and small laboratories. The LLG-uni^{INC}U 20 incubator features a large internal chamber with a capacity of 20 litres, capable of storing flasks and bottles up to 2 litres. In addition, the incubator includes two adjustable/removable shelves for increased capacity, as well as an electrical socket. The digital temperature control eliminates the need for external thermometers and repetitive "fine tuning" of an analog control knob. Optimum temperature distribution throughout the cabinet interior by fan circulation. The LLG-mini tumbling shaker uni^{SHAK}ER 2 which can be positioned inside the incubator (please order separately).

Specifications LLG-uni^{INC}U 20

Temperature range:	Ambient + 5 °C to 60 °C
Accuracy:	±0.5 °C
Temperature uniformity:	±1.5 °C
Capacity:	20 l
External dimensions (W x D x H):	335 x 370 x 475 mm
Internal dimensions (W x D x H):	260 x 235 x 325 mm
Weight:	6.5 kg
Power supply:	100 - 240 V, 50/60 Hz
Warranty:	3 years

Type	PK	Cat. No.
LLG-uni ^{INC} U 20 with EU-plug	1	6.263 570
LLG-uni ^{INC} U 20 with UK-plug	1	6.263 571

1



2



1 Measuring cylinders, borosilicate glass 3.3, tall form, class A, blue graduated

Borosilicate glass 3.3. Conformity certified with batch ID. To DIN EN ISO 4788, DIN 12680. High form, hexagonal foot with spout. Calibrated to contain (IN) and all the tolerances are according to DIN/ISO Class A standards.

Capacity ml	Tolerance ± ml	Height mm	PK	Cat. No.
5	0.05	115	1	9.274 170
10	0.10	140	1	9.274 171
25	0.25	170	1	9.274 172
50	0.50	200	1	9.274 173
100	0.50	260	1	9.274 174
250	1.00	335	1	9.274 175
500	2.50	390	1	9.274 176
1000	5.00	470	1	9.274 177
2000	10.00	570	1	9.274 178



2 Measuring cylinders, PP, tall form, class B, blue graduated

Tall form, highly transparent, with blue graduations, hexagonal base, calibrated to contain (IN). Tolerances class B according to DIN 12681/ISO 6706. Exposure to temperatures above 60 °C may effect accuracy. Cleaning up to max. 60 °C is recommended to preserve marks and inscriptions.

Capacity ml	Tolerance ± ml	Height mm	PK	Cat. No.
10	0.200	135	1	9.274 080
25	0.500	160	1	9.274 081
50	1.000	195	1	9.274 082
100	1.000	240	1	9.274 083
250	2.000	320	1	9.274 084
500	5.000	380	1	9.274 085
1000	10.000	465	1	9.274 086



3 Measuring cylinders, PP, tall form, class B, moulded graduations

- Manufactured from ultra clear, virgin polypropylene and its thick walls eliminate distortion.
- They offer high transparency, chemical resistance and remarkable heat tolerance.
- They meet the highest quality standards according to DIN 12681 and ISO 6706.
- Individually calibrated through automatic calibration process carried out by robots.
- Permanent quality control through all steps eliminate possible deviations from nominal values.
- Cylinders are calibrated to contain (In) and the tolerances are according to DIN/ISO Class "B" standards.
- Graduations are embossed and specially designed for plastic and resistant to 60°C.
- For consistent accuracy, polypropylene measuring cylinders should not be used with liquids over 60 °C and should not be kept under direct sunlight or overheated conditions.

Capacity ml	Tolerance ± ml	Grad. ml	Height mm	PK	Cat. No.
10	0.2	0.2	135	1	6.243 541
25	0.5	0.5	160	1	6.243 542
50	1.0	1.0	195	1	6.243 543
100	1.0	1.0	240	1	6.243 544
250	2.0	2.0	320	1	6.243 545
500	5.0	5.0	380	1	6.243 546
1000	10.0	10.0	465	1	6.243 547





1 Measuring cylinders, PP, tall form, class B, blue moulded graduations

Highly transparent. With easily readable, raised, embossed blue scale and ring marks at the primary scale points. Calibrated 'In'. Class B tolerances according to DIN 12681/ISO 6706. Hexagonal base with bottom studs provides high stability. Thermal stress up to 80 °C does not cause tolerance limits to be permanently exceeded. To preserve markings, do not clean at temperatures exceeding 60 °C. Food-safe (suitable for contact with foodstuff in accordance with Regulation (EC) No. 10/2011).

Capacity	Grad.	Tolerance	Diam.	Height	PK	Cat. No.
ml	ml	± ml	mm	mm		
10	0.20	0.2	15	145	1	9.274 408
25	0.50	0.5	22	170	1	9.274 409
50	1.00	1.0	27	200	1	9.274 410
100	1.00	1.0	33	250	1	9.274 411
250	2.00	2.0	44	315	1	9.274 412
500	5.00	5.0	58	360	1	9.274 413
1000	10.00	10.0	69	440	1	9.274 414
2000	20.00	20.0	97	482	1	9.274 415



2 Measuring cylinders, PP, tall form, class B, moulded graduations

Tall form. Highly transparent. With a raised scale and ring marks at the primary scale points, calibrated 'In'. Class B tolerances according to DIN 12681/ISO 6706. Hexagonal base with bottom studs provides high stability. Thermal stress up to 80 °C does not cause tolerance limits to be permanently exceeded. Food-safe (suitable for contact with foodstuff in accordance with Regulation EC No. 10/2011).

Capacity	Grad.	Tolerance	Diam.	Height	PK	Cat. No.
ml	ml	± ml	mm	mm		
10	0.20	0.2	15	145	1	7.075 031
25	0.50	0.5	22	170	1	9.274 420
50	1.00	1.0	27	200	1	9.274 428
100	1.00	1.0	33	250	1	9.274 438
250	2.00	2.0	44	315	1	9.274 448
500	5.00	5.0	58	360	1	9.274 454
1000	10.00	10.0	69	440	1	9.274 462
2000	20.00	20.0	97	482	1	9.274 464



3 Graduated cylinders, PP, class B, low form, raised scale

Highly transparent. With a raised scale and ring marks at the primary scale points, calibrated 'In'. Products individually packaged in PE bags, labelled with the article number, description and EAN code. Thermal stress up to 80 °C does not cause tolerance limits to be permanently exceeded. Food-safe products according to EC Directive No. 10/2011.

Capacity	Grad.	Height	Tolerance	Diam.	PK	Cat. No.
ml	ml	mm	± ml	mm		
25	0.50	122	0.50	22	1	9.274 820
50	1.00	142	1.00	27	1	9.274 828
100	2.00	163	2.00	37	1	9.274 838
250	5.00	192	5.00	51	1	9.274 848
500	10.00	218	10.00	67	1	9.274 854
1000	20.00	285	20.00	78	1	9.274 862



4 Mixing cylinders, borosilicate glass 3.3, tall form, class A, blue graduated

Borosilicate glass 3.3. Tall form. Conformity certified, with certified batch number. PP stoppers and hexagonal foot. To DIN EN ISO 4788, DIN 12680.

Capacity	Tolerance	Height	PK	Cat. No.
ml	± ml	mm		
25	0.250	195	1	9.275 071
50	0.500	230	1	9.275 072
100	0.500	290	1	9.275 073
250	1.000	370	1	9.275 074
500	2.500	395	1	9.275 075
1000	5.000	510	1	9.275 076

1 Volumetric trapezoidal flasks, Borosilicate glass 3.3, class A, blue graduated

Borosilicate glass 3.3. Conformity certified, with batch certificate. Trapezoidal.
With NS and PP stoppers, to DIN 12664-2, to DIN EN ISO 1042.

Capacity	Tolerance	Joint size (NS)	PK	Cat. No.
ml	± ml			
1	0.025	7/16	1	6.237 705
2	0.025	7/16	1	6.236 426
3	0.025	7/16	1	7.930 290



2 Volumetric flasks, borosilicate glass 3.3, class A, blue graduated, with PP stoppers

Borosilicate glass 3.3. Conformity certified, with batch certificate.
With NS and PP stoppers, to DIN 12664-2, to DIN EN ISO 1042.
Calibrated to contain (IN) and all the tolerances are according to DIN/ISO Class A standards.

Capacity	Tolerance	Joint size (NS)	PK	Cat. No.
ml	± ml			
5	0.025	10/19	1	9.276 600
10	0.025	10/19	1	9.276 601
20	0.040	10/19	1	9.276 602
25	0.040	12/21	1	4.008 300
25	0.040	10/19	1	9.276 603
50	0.060	12/21	1	9.276 604
50	0.060	14/23	1	9.276 605
100	0.100	12/21	1	9.276 606
100	0.100	14/23	1	9.276 607
200	0.150	14/23	1	9.276 608
250	0.150	14/23	1	9.276 609
400	0.200	19/26	1	4.008 302
500	0.250	19/26	1	9.276 610
1000	0.400	24/29	1	9.276 611
2000	0.600	29/32	1	9.276 612
5000	1.200	34/35	1	9.276 613



3 Volumetric flasks, borosilicate glass, amber, class A, white graduated, with PP stoppers

Amber Borosilicate glass with PP stoppers, DE-M marking, with batch certificate and white enamel graduations.
According to DIN EN ISO 1042, DIN 12664-2.
Calibrated to contain (IN) and all the tolerances are according to DIN/ISO Class A standards.

Capacity	Tolerance	Joint size (NS)	PK	Cat. No.
ml	± ml			
5	0.025	10/19	1	9.276 620
10	0.025	10/19	1	9.276 621
20	0.040	10/19	1	9.276 622
25	0.040	10/19	1	9.276 623
25	0.040	12/21	1	4.008 303
50	0.060	12/21	1	9.276 624
50	0.060	14/23	1	9.276 625
100	0.100	12/21	1	9.276 626
100	0.100	14/23	1	9.276 627
200	0.150	14/23	1	9.276 628
250	0.150	14/23	1	9.276 629
500	0.250	19/26	1	9.276 630
1000	0.400	24/29	1	9.276 631
2000	0.600	29/32	1	4.008 306



4 Volumetric flasks, PMP, class A

With NS stoppers, PP. Crystal clear. With ring mark individually calibrated to (IN).
Class A tolerances according to DIN EN ISO 1042. With printed lot number and batch certificate.
Thermal stress up to 121 °C (autoclaving) does not permanently exceed the tolerance limit.
To preserve markings, do not clean at temperatures exceeding 60 °C.
On request also with DAKKS calibration certificate or single certificate.

Capacity	Tolerance	Height	Stopper NS	PK	Cat. No.
ml	± ml	mm			
10	0.04	90	10/19	1	9.276 949
25	0.04	115	10/19	1	9.276 950
50	0.06	150	12/21	1	9.276 951
100	0.10	180	14/23	1	9.276 952
250	0.15	235	19/26	1	9.276 953
500	0.25	270	19/26	1	9.276 954
1000	0.40	310	24/29	1	9.276 955



Volumetric apparatus/Graduated flasks - Standard ground stoppers

1

1 Volumetric flasks, plastic, class B, PP NS-stoppers

To DIN EN ISO 1042, adjusted to IN, with PP standard ground joint stoppers.

Capacity ml	Tolerance ± ml	Joint size (NS)	PK	Cat. No.
25	0.08	10/19	1	9.276 590
50	0.12	12/21	1	9.276 591
100	0.20	14/23	1	9.276 592
250	0.30	14/23	1	9.276 593
500	0.50	19/26	1	9.276 594
1000	0.80	24/29	1	9.276 595

2

2 NS stoppers, PP

NS	PK	Cat. No.
10/19	1	4.008 495
12/21	1	4.008 496
14/23	1	4.008 497
19/26	1	4.008 498
24/29	1	4.008 499
29/32	1	4.008 500

3

3 Stoppers, hollow , PE-HD

Fits standard conical joints. Supplied singly.

NS	PK	Cat. No.
7/16	1	9.230 107
10/19	1	9.230 110
12/21	1	9.230 112
14/23	1	9.230 114
19/26	1	9.230 119
24/29	1	9.230 124
29/32	1	9.230 129
45/40	1	9.230 145
60/46	1	9.230 160



1 Volumetric pipettes, soda glass, class AS, 1 mark, blue graduated

Soda glass. Conformity-certified. With batch date identification.
 DIN EN ISO 648, DIN 12687 and BS 700 - 1583. Calibrated to deliver (EX).
 Ring mark and inscriptions in permanent blue enamel.

Volume	Tolerance	Length	PK	Cat. No.
ml	± ml	mm		
1	0.007	310	1	9.272 260
2	0.010	330	1	9.272 261
3	0.010	360	1	9.272 262
4	0.015	360	1	9.272 263
5	0.015	400	1	9.272 264
10	0.020	440	1	9.272 265
15	0.030	455	1	9.272 267
20	0.030	510	1	9.272 268
25	0.030	520	1	9.272 269
50	0.050	540	1	9.272 270



2 Graduated pipettes, soda glass, class AS, type 3

Soda glass. Conformity-certified. With batch date identification.
 DIN EN ISO 835, DIN 12699 and BS700 - 1583. Calibrated to deliver (EX).
 Ring marks and graduations in permanent blue enamel.

Volume	Graduations	Tolerance	Length	PK	Cat. No.
ml	ml	± ml	mm		
1	0.01	0.007	360	1	9.272 250
2	0.02	0.010	360	1	9.272 251
5	0.05	0.030	360	1	9.272 252
10	0.1	0.050	360	1	9.272 253
20	0.1	0.100	450	1	9.272 254
25	0.1	0.100	450	1	9.272 255
50	0.1	0.200	720	1	9.272 256

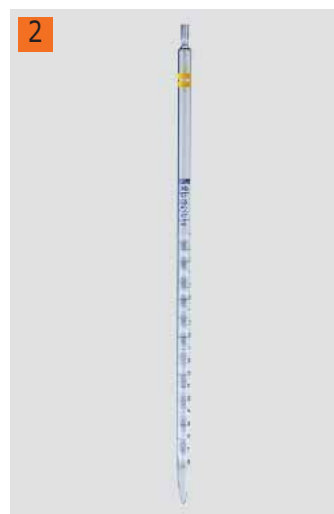

3 LLG-Pasteur pipettes, Soda-lime glass

Single use. With uniform shape and length. With long drawn, 1.1 mm diameter fine tip,
 20 mm suction tube and constriction for tight fitting of cotton wool plugs.
 External diameter: 7.1 mm. Please order Pipette teats separately.

Length	PK	Cat. No.
mm		
150	1000	9.411 015
230	1000	9.411 020



4 LLG-Pasteur Pipettes, PE

Manufactured from transparent PE. Sterile or non-sterile. Graduated.

Type	Capacity	Length	PK	Cat. No.
	ml	mm		
non-sterile	1.0	150	500	9.401 081
non-sterile	3.0	150	500	9.401 080
sterile, single wrapped	1.0	150	1000	9.401 085
sterile, single wrapped	3.0	150	1000	9.401 084



Pipettes/Serological pipettes - Pipette controllers

1

1 LLG-Serological pipettes, PS, sterile

Serological pipettes from LLG are ideally suited for sterile serological and cell culture applications.

Easy to read graduation scales facilitate volume measurement and dosing. All LLG serological pipettes are plugged, sterile, non-pyrogenic and have an increased volume capacity through extra graduations.

LLG Serological pipettes are available in 3 versions with different features.

- Also available as short-pipettes (5 ml, 10 ml and 25 ml) or wide-mouth pipette (10 ml)
- 1 ml, 5 ml, 10 ml, 25 ml and 50 ml pipettes contain a bi-directional secondary graduation scale for precise dosing
- Colour coded ringmark for easy volume identification
- Single packed in easy-to-open plastic/paper packaging

Volume ml	Grad. ml	Colour code	Negative graduations	PK	Cat. No.
1	1/100	yellow	0.3	500	9.380 440
2	1/50	green	0.6	500	9.380 441
5	1/10	blue	3	200	7.930 401
10	1/10	orange	3	200	6.268 240
10	1/10	orange (wide mouth)	3	200	9.380 442
25	2/10	red	8	150	7.930 403
50	5/10	purple	10	100	9.380 443
5	1/10	blue (short form)	3	200	6.265 881
10	2/10	orange (short form)	10	150	6.265 882
25	5/10	red (short form)	9	100	6.265 883

2

2 3 LLG-Electrical pipette Plus

Ergonomic and precise - the cordless and lightweight LLG-Electrical pipette Plus enables fast and exact pipetting with glass and plastic pipettes.

- Fatigue-proof pipetting due to ergonomically shaped handle
- Suitable for left and right handers
- Exchangeable filters protect the device mechanism from contamination
- LED display with speed display: High, Low or Gravity mode (for free liquid flow without drive operation)
- 5 different coloured autoclavable nose pieces and labelling area enables customisation of the pipette
- Extremely quiet and powerful drive
- Low-Battery LED indicator

Scope of supply: Charger (100-240 V, 50/60 Hz), Li-Ion battery, 5 coloured nose pieces, 3 membrane filters, adapter for 1 ml pipettes, benchtop rack, magnetic wall mounting

Specifications

Membrane filters:	PTFE/Ø 25 mm /0.45 µm
Capacity:	1 to 100 ml, glass and plastic pipettes
Pipette attachment:	Polypropylene, autoclavable
Dimensions:	15 x 152 x 41 mm
Weight:	approx. 200 g
Power supply:	rechargeable Li-Ion battery, 8 h continuous operation
Warranty:	1 year

Description	PK	Cat. No.
LLG-Electrical pipette Plus	1	9.281 041
Membrane filter, 0.45 µm, PTFE, non-sterile	5	9.281 005

3

4

4 Macropipette controllers

The handwheel allows precise suction of the liquid into the pipette with one hand.

When the wheel stops, the piston remains in the desired position. The liquid can be blown out by pressing the piston back or allowed to flow out by setting the lateral switch to "Ex".

For	PK	Cat. No.
Pipette volume up to 2 ml	1	4.008 322
Pipette volume up to 10 ml	1	4.008 323
Pipette volume up to 25 ml	1	4.008 324

1 Maxi pipette filler, 1 to 100 ml

Large capacity bulb which works perfectly with all pipette sizes from 1ml up to 100 ml. First squeeze the silicone bulb and the thumb lever controls both the aspirate and dispense modes. Incorporates central button to blow out the residual liquid into the pipettes

Type	PK	Cat. No.
Maxi pipette filler	1	6.238 525



2 Pipette teats

Natural rubber/Latex (NR)
Silicone (VMQ)

Capacity ml	Colour	Material	PK	Cat. No.
1.0	red	NR/Latex	100	7.646 446
2.0	red	NR/Latex	100	4.661 160
2.0	transparent/white	VMQ	10	9.072 682



3 Pipette bulbs

Rubber. For quick and easy pipetting. Colour coding to prevent confusion.

Colour	Capacity ml	PK	Cat. No.
Grey	2	1	9.115 502



4 LLG-Safety pipette bulb, rubber, red

Chemically resistant rubber. With valves for suction, emptying and air release, controlled by thumb and finger pressure.

Type	Figure	PK	Cat. No.
LLG-Safety pipette bulb, normal	A	1	6.270 265
LLG-Safety pipette bulb, universal	B	1	6.270 266
LLG-Safety pipette bulb, "Flip"	C	1	6.270 267



5 Safety pipette bulb Howorka-Ball®

- no rigid connection with tube
- no valves or side vent on tubes
- suitable for all standard tube diameters, including pipettes, burettes, filter tubes etc.
- no unstable air pockets
- long operational life due to durable components
- Easily cleaned and steam sterilized if contaminated with liquids

Capacity ml	PK	Cat. No.
20	1	9.273 826
50	1	9.273 827





1 Pipette stand, horizontal, PP

Pipette stand for 12 pipettes, horizontal is made from moulded polypropylene which is autoclavable. On each side, 6 pipettes (longer than 22 cm) can be stored horizontally. Easy to clean.

Dimensions mm	PK	Cat. No.
210 x 155 x 230	1	9.273 896



2 Pipette stand, vertical, PP

Pipette stand, vertical is made from moulded polypropylene. This stand can hold up to 94 pipettes and rotates on a central vertical axis for easy selection of any particular pipette. The base plate has a raised edge which catches dripping liquids.

Type	PK	Cat. No.
Pipette stand, vertical	1	9.273 895



3 Variable pipette boxes

Comprising two, sliding aluminium sections which can be gently pressed together in a telescopic fashion to fit the length of the pipettes to be sterilized. This means that only one container size for 280 to 420 mm long standard pipettes and one for 145 to 235 mm long, short or pasteur pipettes are required. 2 mm thick silicone rubber pad prevents damage to pipettes when loading and transporting. Silicone rubber pad - please order separately.

Type	Int. diam. mm	Variable length mm	PK	Cat. No.
Pipette box	60	145-235	1	9.010 801
Pipette box	60	280-420	1	9.010 800



1 2 3 4 5 6 LLG-Digital single channel microliter pipettes

Ergonomic shape for very comfortable handling

The rounded shape and the unique soft grip of the LLG pipette ensures a safe and comfortable handling. A minimal effort is required for pipetting so that the risk of repetitive strain injuries (RSI) is reduced.

Maximum Precision and Accuracy

Thermal insulation of the internal components, using the innovative soft grip, improves the accuracy.

Universal Blow-out System

The two-step plunger operation allows reverse pipetting. This also facilitates last drop dispensing by soft plunger movements. High accuracy and precision are guaranteed.

Colour-coded push-button for quick operation

The colour code enables a quick choice of the right pipette depending of the volume to be pipetted (see corresponding column in the table below).

Easy Maintenance and Adjustment

The volume setting is easy and precise, using the push-button, even when wearing gloves. Maintenance and adjustment take only a few minutes with just one tool. (Included in delivery)

Contamination-free Pipetting

The pipette is fully autoclavable, ideal for applications where sterility is important.

Satisfaction Guaranteed

Each pipette is individually tested and calibrated twice, conforming to EN ISO 8655 and DIN 12600 Standards. A certificate is included.

Made in Germany, CE certified.

1



2



3



4



5



6



LLG-Digital single channel microliter pipettes, variable

Capacity µl	Increments µl	Accuracy max. vol. (≤ ± R%)	Precision max. vol. (≤ CV%)	Colour code	PK	Cat. No.
0.1 - 2.5	0.05	1.5	0.8	grey	1	9.280 000
0.5 - 10	0.1	1.0	0.5	grey	1	9.280 001
2 - 20	0.5	4.5	1.0	grey	1	9.280 002
10 - 100*	1.0	2.8	0.8	yellow	1	9.280 003
20 - 200	1.0	2.5	0.6	yellow	1	9.280 004
100 - 1000*	5.0	2.9	0.6	blue	1	9.280 005
500 - 5000*	50.0	2.4	0.6	purple	1	9.280 006
1000 - 10000**	100.0	3.0	0.6	turquoise	1	9.280 007

*Filters for pipettes available on request.
** 10000µl pipette does not have a tip ejector

1 LLG-Digital single channel microliter pipettes, Packages, variable

Package 1 Micro contains:

- a) 3 Microlitre pipettes with the volumes
 - LLG-microlitre pipette 0.5 to 10 μl
 - LLG-microlitre pipette 10 to 100 μl
 - LLG-microlitre pipette 100 to 1000 μl
- b) for each pipette one bag of tips
 - crystal (0.1 to 10 μl) 1000 tips
 - yellow (10 to 100 μl), 1000 tips
 - blue (100 to 1000 μl), 1000 tips

Package 2 Macro contains:

- a) 3 Microliter pipettes with the volumes
 - LLG-microlitre pipette 100 to 1000 μl
 - LLG-microlitre pipette 500 to 5000 μl
 - LLG-microlitre pipette 1000 to 10000 μl
- b) for each pipette one bag of tips
 - blue (100 to 1000 μl), 1000 tips
 - clear (100 to 5000 μl), 250 tips
 - clear (1000 to 10000 μl), 100 tips

Package 1 Micro and 2 Macro are also available as packages with 4-place or 6-place pipette stand, made of PMMA.

Type	PK	Cat. No.
Package 1 Micro	1	9.280 008
Package 2 Macro	1	9.280 009
Package 1 Micro + 4-place-pipette stand	1	6.237 000
Package 1 Micro + 6-place-pipette stand	1	6.237 001
Package 2 Macro + 4-place-pipette stand	1	6.237 002
Package 2 Macro + 6-place-pipette stand	1	6.237 003

1



1 | 2 | 3 Single channel microliter pipettes LLG-proMLP

The LLG-proMLP single channel microliter pipettes combine high accuracy and reliability with ergonomic and extremely low force pipetting relieving stress from your hand and thumb. This high precision instrument has been built to maintain accuracy for many years making it the ideal choice for all scientific work requiring exact and reproducible pipetting.

The LLG-proMLP pipettes are equipped with an adjustable eject button allowing right and left handed users to set the button*according to their preferences. The built in volume locking mechanism and competitive pricing complete these high quality precision pipettes. Available volume ranges from 0.2 µl to 10 ml.

- High quality **Made in France**
- High accuracy, reliability and reproducibility
- Extremely light weight while the robustness still remains
- Perfect ergonomics for highest comfort
- Colour-coded push-button for quick operation
- Extremely low pipetting forces
- **Built-in volume locking** for error-free results
- **Tip ejector button***, adjustable for right- and left-handed users
- Completely autoclavable at 121 °C
- Including individual calibration certificate (according to EN ISO 8655)

*not available for 5 ml and 10 ml pipettes

Capacity µl	Increments µl	Accuracy max. vol. (≤ ± R%)	Precision max. vol. (≤ CV%)	Colour code	PK	Cat. No.
0.2-2	0.002	1.65	0.75	dark orange	1	6.270 420
0.5-10	0.02	1.10	0.44	red	1	6.270 421
2-20	0.02	1.00	0.33	light yellow	1	6.270 422
10-100	0.2	0.80	0.17	light orange	1	6.270 423
20-200	0.2	0.80	0.17	dark yellow	1	6.270 424
100-1000	2	0.80	0.17	dark blue	1	6.270 425
500-5000	2	0.66	0.18	purple	1	6.270 426
1000-10000	20	0.60	0.18	light blue	1	6.270 427



4 LLG-Pipette stands for single channel microliter pipettes, PMMA

White, stable plastic (PMMA), industrial grade. Pipettes are held in an ergonomic position for easy withdrawal and replacement. Adjustable heights. Suitable for all kind of pipettes.



Description	PK	Cat. No.
for 4 pipettes	1	9.280 014
for 6 pipettes	1	9.280 011

1

9.409 046

2

9.409 048

3

9.409 097

LLG-Pipette tips *economy*, non-sterile

Made of Polypropylene. Certified free of DNase, RNase, suitable for microbiology. Guaranteed metal-free.

LLG universal fit tips are engineered for a wide variety of pipettes and are ideal for laboratories with multiple brands of pipettes, even multi-channel pipettes. Our universal tips feature the universal grip design, using flexible materials with a series of bands and supports producing a positive seal. LLG tips have thin walls and a small surface area at the tip, greatly minimising the possibility of the tip retaining sample droplets. In addition, the small surface area reduces the touch-off angle between the outer tip wall and the receiving sample tube. This reduced touch-off angle virtually eliminates the potential of capillary retention between the tip orifice and tube wall. Each of our tips is moulded to give a flash-free and uniform delivery orifice for consistent accuracy and reproducible sample delivery. All our tips are provided with calibration lines at specific volumes, acting as visual checks to minimise any risk of errors during sample aspiration.

Colour	Capacity µl	Package contents	PK	Cat. No.
clear	0.1 - 10	1 bag of 1000	1000	9.409 099
clear	0.1 - 10	10 racks of 96	960	9.409 045
yellow	1 - 200	1 bag of 1000	1000	9.409 046 1
clear	1 - 200	10 racks of 96	960	6.253 577
yellow	1 - 200	10 racks of 96	960	9.409 047
blue	100 - 1000	2 bags of 500	1000	9.409 048 2
blue	100 - 1000	10 racks of 96	960	9.409 049
clear	100 - 5,000*	1 bag of 250	250	9.409 097 3
clear	100 - 5,000**	1 bag of 250	250	6.254 364
clear	1,000 - 10,000	1 bag of 100	100	9.409 098

*for manual pipettors

**for electronic pipettors

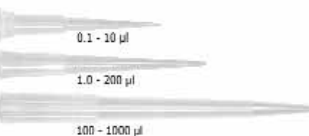
4

4 LLG-Low-Retention Pipette tips pipettes, non-sterile

Certified free of DNase, RNase, suitable for microbiology. Guaranteed metal-free.

Sample retention can be a major contributor to pipetting inaccuracy, and siliconization of tips has proved unsatisfactory because of autoclaving and contamination problems. For LLG pipette tips a new polymer, Novelle-Polypropylene has been developed, that produces a "super slick surface" on our new LLG pipette tips, that actually improves with autoclaving and cannot leach from the tip surface. On average, Novelle Polymer and LLG pipette tips reduces the tip retention by near 85 % and decreases the standard deviation of the retained volume by more than 75 %.

Liquid handling accuracy and precision are crucial to success in today's molecular biology laboratories, especially for DNA analysis and protein handling. A significant culprit of pipette inaccuracy is binding of sample.

The LLG pipette tips reduces the binding, thus increasing sample delivery accuracy.

Colour	Capacity µl	Package contents	PK	Cat. No.
Clear	0.1 - 10	1 bag of 1000	1000	9.409 038
Clear	0.1 - 10	10 racks of 96	960	9.409 039
Clear	1 - 200	1 bag of 1000	1000	9.409 041
Clear	100 - 1000	2 bags of 500	1000	9.409 043

5

5 LLG-Low retention filter tips, sterile

Certified free of DNase, RNase, suitable for microbiology. Guaranteed metal-free.

Sterility acc. to EN 552/ISO 11137 and DIN EN 556.

Filter pore size (effective) 4 to 6 µm.

Also liquid handling accuracy and precision are crucial to success in today's molecular biology laboratories, especially for DNA analysis and protein handling. A significant culprit of pipette inaccuracy is binding of sample.

The LLG-Filter tips reduce the binding, thus increasing sample delivery accuracy. Tests demonstrate that LLG-Filter tips significantly reduce the amount of DNA and protein bound by the tip. Furthermore LLG-Filter tips "Premium" offer a marked improvement over the best low retention technologies.

Colour	Capacity µl	Package contents	PK	Cat. No.
Clear	0.1 - 10	10 racks of 96	960	9.409 033
Clear	1 - 20	10 racks of 96	960	9.409 034
Clear	1 - 100	10 racks of 96	960	9.409 035
Clear	1 - 200	10 racks of 96	960	9.409 036
Clear	100 - 1000	10 racks of 96	960	9.409 037

1 LLG-Pipette tip Refill system *ULTRALOW*

The new LLG-Pipette tip Refill system *ULTRALOW* consists of racked tips and easy-to-use, environmentally friendly pipette tip refills.

All LLG-Pipette tips *ULTRALOW* feature an extremely low liquid retention compared to standard tips due to their hydrophobic inner side. This enables accurate, more complete and more precise dispensing of fluids, even of viscous ones!

LLG refills are easy to use allowing a quick filling of empty racks. Its packaging is made out of recyclable paperback which reduces the overall waste production and is absolutely environmentally friendly!

LLG-Pipette tip Refill system *ULTRALOW* is compatible with all major pipette brands such as LLG-proMLP, Gilson, Eppendorf, Brand, Sartorius, Socorex and others.

Features:

- Ultralow retention tips with easy visible volume graduations
- Universal fit tips, compatible with common pipette brands
- Easy-to-use lift-and-load refill system
- Refill inserts are imprinted with volume and LOT No. for easy identification
- 50 % less storage space than full racks
- 70 % reduction in total materials compared to other refill systems
- environmentally friendly and recyclable packing materials made out of paperboard
- Rack footprint is compatible with automation and facilitates stacking, autoclavable



2 LLG-Pipette Tips *ULTRALOW*, Refill System

Capacity	Package contents	PK	Cat. No.
µl			
10	10 x 96	960	6.283 565
200	10 x 96	960	6.283 568
1250	8 x 96	768	6.283 570



3 Racks for LLG-Pipette Tips *ULTRALOW*, empty

Description	PK	Cat. No.
for 10 µl XL and 200 µl LLG- Pipette Tips <i>ULTRALOW</i> Refill System	5	6.283 566
for 1250 µl LLG- Pipette Tips <i>ULTRALOW</i> Refill System	5	6.283 571



4 LLG-Pipette Tips *ULTRALOW*, Rack

Capacity	Package contents	PK	Cat. No.
µl			
10	10 racks of 96 tips	960	6.283 567
200	10 racks of 96 tips	960	6.283 569
1250	8 racks of 96 tips	768	6.283 572



1

1 LLG-Disposable Reagent reservoirs economy, PS

Made from polystyrol. Designed for use with multi-channel pipettes and can accommodate up to 12-channel standard pipettes. Angled sides and a V-shaped bottom allow maximum recovery of reagents. All reservoirs have internal graduated volume lines and pour-spouts on the corners. 25 ml or 50 ml versions. Available as sterile and non-sterile versions.

Description	Capacity ml	PK	Cat. No.
non-sterile, bulk	25	100	6.282 144
sterile, single packed	25	100	6.282 145
non-sterile, bulk	50	100	6.282 146
sterile, single packed	50	100	6.282 147

2

2 Manual Serial Dispenser LLG-uniDISPENS

The **ergonomically designed** manual dispenser LLG-uniDISPENS enables single handed volume selection, loading and dispensing. Due to its light weight it is ideally suited for serial dosing. You can flexibly select your desired dosing volume from **120 dosing programs** for 12 tip sizes and with 10 stroke adjustments. You can view all settings and volumes at a single glance through the viewing window of the manual dispenser. The dispenser is **compatible with Ritips® from Ritter, PD-Tips® from Brand, Combitips® and Combitips advanced® from Eppendorf™**. Thanks to a purely mechanical, maintenance-free construction, the manual dispenser is a practical and convenient device for daily laboratory use. 3 years warranty.

Scope of delivery: Adapter for 25 ml tips included

Description	PK	Cat. No.
LLG-uniDISPENS	1	9.284 238
Spare adapter for 25 ml	1	6.310 203
Spare adapter for 50 ml	1	6.310 548

Dispenser tips, ritips®

- Three sizes, standard and bioclean® (sterile).
- Maximum of safety and repeatability as all tips are individually and mechanically tested.
- Guaranteed purity under the logo bioclean® is tested and confirmed by independent testing laboratories. Ritter bioclean® stands for sterile, pyrogen free, DNA-, RNase- and ATP-free.
- A quality certificate per lot can be obtained upon request.

Suitable for use together with Ritter ripette®, Multipette® 4780, HandyStep®, Minilab 100/101, Stepmate, EasyStep, Distriman® and HandyStep® electronic.

Please note: Dispenser tips ritips® 25ml and 50ml cannot be used without adapter. If necessary, please order Cat.-No. 6.310 203 or 6.310 548 separately.

Type	PK	Cat. No.
0.05 ml / standard	100	6.265 688 3
1.25 ml / standard	100	6.265 689 4
12.5 ml / standard	100	9.284 225 5
0.05 ml / bioclean® sterile	100	6.290 742
1.25 ml / bioclean® sterile	100	6.265 691
12.5 ml / bioclean® sterile	100	6.288 768

3

6.265 688

4

6.265 689

5

9.284 225

1 Bottletop dispenser LLG-uniTOPDISPENS 2

The combination of a springless PTFE valve and **PTFE piston** with chemically resistant ETP O-ring enables dispensing of both organic reagents as well as bases, thus, eliminating the need to buy different dispensers for different applications. The improved design of the uniTOPDISPENS 2 bottle top dispenser including a **re-circulation valve** allows a smooth, precise and reliable bubble free dispensing without any loss of reagent. The specially designed bottle adaptor which permits a 360° rotation of the unit, the easy volume setting as well as the flexible delivery nozzle underline the user friendliness of this bottletop dispenser. Available in six volume ranges.

- Springless PTFE valve, PTFE piston with chemically resistant ETP O-ring enables **high chemical compatibility**
- Glass cylinder from borosilicate glass 3.3
- Re-circulation valve enables easy priming and bubble free dispensing
- Smooth, reproducible and effortless dispensing
- 360° rotation possible due to specially designed bottle adapter
- Flexible and adjustable delivery nozzle provides **dispensing angle flexibility** to the user
- Specially designed volume adjustment knob for quick and easy volume setting
- **The telescopic extractable intake tube can be easily adjusted to varying bottle heights**
- Nozzle cap reduces contact with air and prevents drying and dripping if the tip cover is attached
- Five bottle adaptors included (28 mm, 32 mm, 37 mm, 40 mm and 45 mm). Standard thread: 30 mm.
- Fully autoclavable at 121 °C, 15 psi for 10 to 15 min
- Individually calibrated in accordance with ISO 8655 standards and each unit is supplied with an individual calibration certificate
- 3 years warranty

Description	Volume	Graduations	Accuracy	Precision	PK	Cat. No.
	ml	ml	max. vol. (≤ ± R%)	max. vol. (≤ CV%)		
LLG-uniTOPDISPENS 2	0.25 - 2.5	0.05	0.6	0.2	1	6.282 275
LLG-uniTOPDISPENS 2	0.5 - 5	0.1	0.6	0.2	1	6.282 276
LLG-uniTOPDISPENS 2	1 - 10	0.2	0.6	0.2	1	6.282 277
LLG-uniTOPDISPENS 2	2.5 - 30	0.5	0.6	0.2	1	6.282 278
LLG-uniTOPDISPENS 2	5 - 60	1.0	0.6	0.2	1	6.282 279
LLG-uniTOPDISPENS 2	10 - 100	2.0	0.6	0.2	1	6.282 280



2 Bottletop dispenser LLG-uniTOPDISPENS 2 DUO

Moreover, the LLG-uniTOPDISPENS 2 DUO enables 4 modes of dispensing in just one Dispenser: Dilution, Rinsing, Dual Liquid Handling and Re-circulation in a single unit. All these features underline the user-friendliness and versatility of this next generation bottletop dispenser. Available in six volume ranges.

- Refilling and rinsing without the need to dismount
- 4 modes of dispensing: Dilution, Rinsing, Dual Liquid Handling and Re-circulation in a single unit
- Springless PTFE valve and piston, with chemically resistant ETP O-ring, enable **high chemical compatibility**
- Glass cylinder from borosilicate glass 3.3
- Smooth, reproducible and effortless dispensing
- 360° rotation possible due to specially designed bottle adapter
- Flexible and adjustable delivery nozzle provides dispensing angle flexibility to the user
- Specially designed volume adjustment knob for quick and easy volume setting
- **The telescopic extractable intake tube can be easily adjusted to varying bottle heights**
- Nozzle cap reduces contact with air and prevents drying and dripping if the tip cover is attached
- Five bottle adaptors included (28 mm, 32 mm, 37 mm, 40 mm and 45 mm); thread: 30 mm
- Fully autoclavable at 121 °C, 15 psi for 10 to 15 min
- Individually calibrated in accordance with ISO 8655 standards and each unit is supplied with an individual calibration certificate
- 3 years warranty

Description	Volume	Graduations	Accuracy	Precision	PK	Cat. No.
	ml	ml	max. vol. (≤ ± R%)	max. vol. (≤ CV%)		
LLG-uniTOPDISPENS 2 DUO	0.25 - 2.5	0.05	0.6	0.2	1	6.282 281
LLG-uniTOPDISPENS 2 DUO	0.5 - 5	0.1	0.6	0.2	1	6.282 282
LLG-uniTOPDISPENS 2 DUO	1 - 10	0.2	0.6	0.2	1	6.282 283
LLG-uniTOPDISPENS 2 DUO	2.5 - 30	0.5	0.6	0.2	1	6.282 284
LLG-uniTOPDISPENS 2 DUO	5 - 60	1.0	0.6	0.2	1	6.282 285
LLG-uniTOPDISPENS 2 DUO	10 - 100	2.0	0.6	0.2	1	6.282 286



1

1

Bottletop dispenser LLG-uniTOPDISPENS with glass piston and clear glass cylinder

The LLG-uniTOPDISPENS is a **reasonably priced** bottle-top dispenser with **glass piston** available in 2 volumes: 10 ml and 50 ml. Precise, reliable and robust. The high quality of the material used and the precision of the grinding ensures the perfect seal of the complete dispensing system. 3 years warranty.

- Precise and reliable volume setting
- Visible dosing procedure
- Valve block made of PP gives optimised protection of the glass made dosing cylinder
- Precise grinding of the glass piston into the glass cylinder forms a perfect seal
- Ergonomic finger guard
- Delivered with 2 PP-adapters GL 40 and 45
- With glass piston and clear glass cylinder

Description	Volume	Graduations	Accuracy max. vol. ($\leq \pm R\%$)	Precision max. vol. ($\leq CV\%$)	PK	Cat. No.
	ml					
LLG-uniTOPDISPENS	2 - 10	0.2	0.6	0.2	1	9.283 806
LLG-uniTOPDISPENS	10 - 50	1.0	0.6	0.2	1	9.283 808

2

2

Burettes, with straight stopcock, borosilicate glass 3.3, class AS

With class AS, conformity certified, with batch identification, blue graduations, DIN EN 385. PTFE spindle.

Description	Capacity		Grad.	Tolerance	PK	Cat. No.
	ml	ml				
with Schellbach line	10	0.02	0.020		1	4.008 311
with Schellbach line	25	0.05	0.030		1	9.270 100
with Schellbach line	50	0.10	0.050		1	9.270 101
without Schellbach line	10	0.02	0.020		1	9.270 102
without Schellbach line	25	0.05	0.030		1	9.270 103
without Schellbach line	50	0.10	0.050		1	9.270 104

3

4.008 314

4

4.008 316

Automatic burettes, schilling pattern, borosilicate glass 3.3/PE-LD

- Described as automatic burettes with fast titration and practical usage.
- Especially suitable for field analysis where there is a risk of breaking.
- The entire system consists of a burette tubing with automatic zeroing system together with a valve stopcock, a reservoir bottle and a bottle stand.
- Rapid filling by squeezing the bottle and fast titration by valve stopcock
- Inscriptions and graduations are printed either with blue enamel or with white enamel which is specially designed for glass use.
- Clear burettes are manufactured with schellbach stripe.
- Amber burettes are manufactured without schellbach stripe.
- 10 ml burette has a polyethylene reservoir bottle of 500 ml volume whereas 25 and 50 ml burettes are used with bottles of 1000 ml volume.

Description	Capacity		Grad.	Tolerance	PK	Cat. No.
	ml	ml				
clear glass, schellbach, blue graduated	10	0.05	0.030		1	4.008 314 3
clear glass, schellbach, blue graduated	25	0.10	0.050		1	6.241 904
clear glass, schellbach, blue graduated	50	0.10	0.050		1	4.008 315
amber, without schellbach, white graduated	10	0.05	0.030		1	4.008 316 4
amber, without schellbach, white graduated	25	0.10	0.050		1	4.008 317
amber, without schellbach, white graduated	50	0.10	0.050		1	4.008 318

Automatic burettes, borosilicate glass 3.3, class AS

- Manufactured from pre-vacuum calibrated borosilicate glass. They meet the highest quality standards according to DIN EN ISO 385 and DIN 12700.
- Permanent quality control through all steps eliminates possible deviations from nominal values.
- Calibrated to deliver (Ex) and the tolerances are according to DIN/ISO Class "AS" standards.
- Conformity ("H") certified, with a batch number printed on the body.
Batch certificate can be downloaded from the suppliers website.
- Supplied with an automatic zeroing system, VALVE stopcock and also an intermediate PTFE stopcock to recirculate the remaining liquid.
- Clear burettes are manufactured with schellbach stripe.
- Inscriptions and graduations are printed with special blue enamel.
For amber burettes, white enamel is used to maximise visibility and durability.



4.008 312

6.238 473

Glass bottle - Please order separately.

Description	Capacity		Tolerance	Glass	Graduations	PK	Cat. No.
	ml	ml					
schellbach	10	0.02	± 0.020	clear	blue graduated	1	4.008 312 1
schellbach	25	0.05	± 0.030	clear	blue graduated	1	6.241 216
schellbach	50	0.10	± 0.050	clear	blue graduated	1	6.237 627
without schellbach	10	0.02	± 0.020	amber	white graduated	1	6.238 473 2
without schellbach	25	0.05	± 0.030	amber	white graduated	1	6.242 463
without schellbach	50	0.10	± 0.050	amber	white graduated	1	6.241 116

3 4 Burette bottles, borosilicate glass 3.3

Burette bottle for automatic burettes is made from heat resistant glass. Each bottle has a NS 29/32 neck grinding that fits to burette.

Colour	Capacity ml	Diam. mm	Height mm	PK	Cat. No.
clear	2000	160	200	1	6.237 628
brown	2000	160	200	1	6.238 474



5 Orsat blowball

Natural rubber. Translucent.

Type	PK	Cat. No.
Orsat blowball	1	9.115 510



6 Hand bellows

Single spray. Without net.
Size 3.

Type	PK	Cat. No.
Hand bellows	1	9.270 995



7 Hand bellows

Double spray. With net.
Size 5.

Type	PK	Cat. No.
Hand bellows	1	9.270 990



1

1 Water jet pumps, PP

With constant ultimate vacuum, high suction flow rate and very low water consumption. Can be connected to mains water system in a number of different ways using the adapter supplied and reducing adapters that are available as accessories. For continuous use at temperatures up to 80°C max. High chemical resistance as the media being pumped only comes into contact with PP, FKM and PTFE. Integral non-return valve increases safety.

Comprises: Water jet pump, including:

Mains water connections: R ¾" sleeve nut, R ½" reducing adapter and flexible tubing connection (nozzle) with external diameter from 10 mm to 12 mm.

Vacuum connection: Detachable nozzle with external diameter from 6 mm to 9 mm and GL 14 screw cap.

Type	PK	Cat. No.
Water jet pump	1	9.303 125

2 Piston pump LLG-uniVACUUPUMP 1

The **portable** piston pump uniVACUUPUMP 1 has been developed **for vacuum and pressure applications** in the laboratory, in particular in the field of Life Science. Typical applications for this low-cost vacuum pump are the single funnel filtration of aqueous and buffered solutions, SPE, as well as any applications where no harmful gases are conveyed. The uniVACUUPUMP 1 operates oil-free and can also be used as a compressor to a pressure up to 3.3 bar. This allows you, for example, pressure filtration, if vacuum filtration is not sufficient. Not recommended for pumping organic, acidic, or basic vapours.

Advantages:

- Dry-running technology for physical applications
- Can be used as a vacuum pump and compressor
- Cost-effective alternative for water pumps
- Sound suppressor for quiet operation
- Compact, light weight and portable
- oil-free, suitable for continuous operation

Scope of delivery: Pump, incl. 2 hose clamps, EU + UK-plug power cord.

Specifications

Pump speed 50/60 Hz at atmospheric pressure:	9.2 l/min
Final pressure:	292 mbar
Overpressure, max.:	3.3 bar
Suction/pressure connection:	hose nozzle DN 6 for hose inner diameter 6 mm
Ambient temperature:	+ 10 to + 40 °C
Max. Operating gas temperature:	+ 60 °C
Noise DIN EN ISO 2151:	dB (A) ≤ 45
Voltage/frequency:	230 V/50 Hz
Motor power:	25 W
Dimensions (W x D x H):	194 x 114 x 191 mm
Weight:	2.0 kg
Protection class:	IP 20
Warranty:	3 years

Type	PK	Cat. No.
LLG-uniVACUUPUMP 1	1	6.263 580

2

1 LLG-Vacuum measuring instrument DVR 2 pro

Versatile vacuum gauge for vacuum measurement between atmospheric pressure and 1 mbar. With integral, alumina ceramic, pressure transducer providing excellent corrosion resistance and long-term stability.

- Mains independent due to battery operation
- Large display
- High measuring accuracy
- Optimal menu navigation
- With support rod
- All parts in contact with media are made of chemically resistant materials

DKD initial delivery calibration (Cat. No. 7.059 540) please order separately.

Scope of supply: Vacuum measuring instrument with connections for small flange D16, compression fitting and tubing nozzle for tubing with 6 to 10 mm ID.

Specifications

Measuring range:	1080 to 1mbar (hPa), 810 to 1 Torr
Measurement principle:	Capacitive; gas type-independent absolute pressure measurement
Measuring accuracy:	< 1mbar (0.75 Torr) ±1 digit
Power supply/battery:	9V battery
Dimensions (W x D x H):	115 x 115 x 66 mm
Weight:	0.40 kg

Type	PK	Cat. No.
DVR 2 pro	1	6.263 582

1



2 LLG-Desiccators, soda-lime glass, with lid, stopcock and porcelain plate

Desiccator made of soda-lime glass with lid, porcelain plate and stopcock. The stopcock has an outer diameter of about 9 mm. Not suitable for vacuum-tight applications.

Ext. diam. mm	Plate diam. mm	Height mm	PK	Cat. No.
215	140	224	1	9.042 740
262	190	239	1	9.042 741
293	235	278	1	9.042 742
380	280	414	1	9.042 743

2

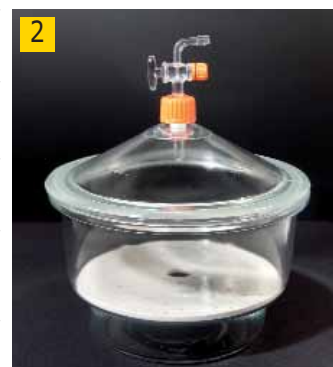

3 Vacuum-Desiccators with tubes, borosilicate glass 3.3, stopcock SJ 24/29 and porcelain plate

Desiccators borosilicate glass 3.3, vacuum-tight. The stopcock has an outer diameter of approx. 9 mm.

Ext. diam. mm	Plate diam. mm	DN	PK	Cat. No.
151.0	90	100	1	9.042 815
210.0	140	150	1	6.226 934
269.0	190	200	1	6.226 935
329.0	240	250	1	6.226 936
392.0	290	300	1	6.227 443

3



4 LLG-Plate for desiccator, porcelain

Perforated. Without feet. To DIN 12911. 20 mm diameter central hole and 5 mm diameter outer holes.

For DN	Diam. mm	PK	Cat. No.
100	90	1	9.042 801
150	140	1	9.042 802
200	190	1	9.042 803
250	235	1	9.042 804
300	280	1	9.042 805

4



1 LLG-Vacuum desiccators, polycarbonate, round form, "Heavy Duty"

Cost effective alternative to glass desiccators. Highly transparent, lightweight, shatterproof, made of polycarbonate.

Silicon O-ring and specially designed 'locking clip' allows use without grease and ensures an airtight seal. Flange lock holds the bottom and the lid together during non-vacuum conditions. Three-way stopcock provides great convenience for consistent vacuum draw, vacuum release or gas exchange e.g. inert gas. Maximum vacuum of 1.3 mbar (1.3×10^{-4} MPa) for more than 72 hours. Wide base provides superior stability. Hose connection diam. 9.5 mm.

Also available in brown with UV-blocking effect for light sensitive samples.

G Models will be delivered with a vacuum gauge.

Included in delivery: Drying agent tray, perforated sample tray, O-ring and flange locker.

Type	Capacity	Ext. diam.	Height	PK	Cat. No.
	l	mm	mm		
VDR-20 Vacuum Desiccator	6	242	279	1	9.042 751
VDR-20U Vacuum Desiccator with ultraviolet block effect	6	242	279	1	9.042 752
VDR-20G Vacuum Desiccator with gauge	6	242	354	1	9.042 753
VDR-20UG Vacuum Desiccator with ultraviolet block effect and gauge	6	242	354	1	9.042 754
VDR-25 Vacuum Desiccator	10	308	325	1	9.042 755
VDR-25U Vacuum Desiccator with ultraviolet block effect	10	308	325	1	9.042 756
VDR-25G Vacuum Desiccator with gauge	10	308	400	1	9.042 757
VDR-25UG Vacuum Desiccator with ultraviolet block effect and gauge	10	308	400	1	9.042 758
VDR-30 Vacuum Desiccator	20	385	399	1	9.042 759
VDR-30U Vacuum Desiccator with ultraviolet block effect	20	385	399	1	9.042 760
VDR-30G Vacuum Desiccator with gauge	20	385	475	1	9.042 761
VDR-30UG Vacuum Desiccator with ultraviolet block effect and gauge	20	385	475	1	9.042 762

1



Accessories for LLG-Vacuum desiccators VDR Series

Description	PK	Cat. No.
Drying Agent Tray for VDR-20 Series	1	9.042 771
Drying Agent Tray for VDR-25 Series	1	9.042 772
Drying Agent Tray for VDR-30 Series	1	9.042 773
Perforated Sample Tray for VDR-20 Series	1	9.042 776
Perforated Sample Tray for VDR-25 Series	1	9.042 777
Perforated Sample Tray for VDR-30 Series	1	9.042 778
Lock ring for VDR-20 series	1	9.042 781
Lock ring for VDR-25 series	1	9.042 782
Lock ring for VDR-30 series	1	6.260 351
Vacuum gauge for VDR series	1	9.042 783
Vacuum seal for VDR-20 series	1	9.042 785
Vacuum seal for VDR-25 series	1	9.042 786
Vacuum seal for VDR-30 series	1	6.260 350
Stopcock for VDR series	1	6.260 353

1 2 LLG-Vacuum desiccator cabinets, polycarbonate, square form, "Heavy Duty"

High-quality and stable construction made of polycarbonate. Highly transparent, lightweight, shatterproof and stackable. The Silicon O-ring and specially designed locking clip allow use without grease. Three-way stopcock provides great convenience for consistent vacuum draw, vacuum release or gas exchange e.g. inert gas. Stopcock outer diameter: 9.5 mm. Hose connection diam. 9.5 mm. Maximum vacuum of 1.3mbar (1.33×10^{-4} MPa) for more than 72 hours, with built-in vacuum gauge.

Also available in brown with UV-blocking effect for light sensitive samples.

Included in delivery: Vacuum gauge, O-ring, drying agent tray, 2 x perforated sample trays (VDC-11 and VDC-21) or 3 x perforated sample trays (VDC-31 and VDC-41).

Type	Capacity	External dimensions (W x D x H) mm	Internal dimensions (W x D x H) mm	Max. number shelves	PK	Cat. No.
VDC-11	11	322 x 285 x 271	248 x 254 x 238	4	1	9.042 769
VDC-21	23	420 x 392 x 281	346 x 365 x 246	4	1	9.042 767
VDC-31	35	420 x 397 x 381	355 x 375 x 345	5	1	9.042 765
VDC-41	45	420 x 397 x 491	355 x 374 x 445	6	1	9.042 763
VDC-11U (amber, UV-block effect)	11	322 x 285 x 271	248 x 254 x 238	4	1	9.042 770
VDC-21U (amber, UV-block effect)	23	420 x 392 x 281	346 x 365 x 246	4	1	9.042 768
VDC-31U (amber, UV-block effect)	35	420 x 397 x 381	355 x 375 x 345	5	1	9.042 766
VDC-41U (amber, UV-block effect)	45	420 x 397 x 491	355 x 374 x 445	6	1	9.042 764

1



2



3 Accessories for LLG-Vacuum desiccator cabinets VDC Series

Description	PK	Cat. No.
Desiccant Tray for VDC-41/31/21 Series	1	9.042 774
Desiccant Tray for VDC-11 Series	1	9.042 775
Sample Tray for VDC-41/31/21 Series	1	9.042 779
Sample Tray for VDC-11	1	9.042 780
Vacuum gauge for VDC series	1	9.042 784
Vacuum seal for VDC-11/11U	1	9.042 790
Vacuum seal for VDC-21/21U	1	9.042 789
Vacuum seal for VDC-31/31U	1	9.042 788
Vacuum seal for VDC-41/41U	1	9.042 787
Stopcock for VDC series	1	6.262 107



Desiccators Auto Dry Box

Automatic drying and storage without desiccant. Ideal for the long-term storage of e.g. Reference samples, electronic components or optical instruments under defined moisture conditions. Relative humidity adjustable in 3 steps between 25 % and 55 % relative humidity, very quiet operation. Includes 1 to 3 shelves, lockable glass door and analogue hydrometer. Model RT-48C with pull-out shelf.

Specifications

Max. load shelves: 10 kg
Power: 220-240 V

Type	Internal dimensions (W x D x H) mm	External dimensions (W x D x H) mm	Volume litres	Max. number shelves	Power consumption W	PK	Cat. No.
HD-40GD	298 x 297 x 274	340 x 350 x 390	32	1	4	1	6.286 116 1
RT-48C	272 x 329 x 387	312 x 384 x 470	46	1	4	1	6.286 117
AD-75	360 x 357 x 460	400 x 412 x 555	72	3	4	1	6.286 118
AD-106	360 x 357 x 740	400 x 412 x 835	114	3	6	1	6.286 119

1



6.286 116

2



2 LLG-Desiccant drying agents, silica gel, self-indicating

With orange indicator colour. Grain size 1 to 3 mm or 2 to 5 mm. Self-indicating drying agent free from any heavy metals and therefore environmentally compatible.

The gel is naturally orange when active and at a 6 weight-% saturation level. As the gel adsorbs moisture, the colour changes into green. The range of application is identical with that of white silica gel. The colour change, however, represents a great advantage since it allows monitoring of the saturation level.

The gel can be regenerated when heated at a temperature of maximum 120 °C until it turns to its original orange colour.

Adsorption capacity	RH 20 % 12 weight %
(RH : residual moisture)	RH 35 % 20 weight %
	RH 50 % 27 weight %
	RH 90 % 40 weight %

Granulation	Package contents	PK	Cat. No.
1 to 3 mm	Tin, kg	1	9.042 584
1 to 3 mm	Bucket, 3 kg	1	9.042 585
1 to 3 mm	Bucket, 8 kg	1	9.042 586
1 to 3 mm	Carton box, 25 kg	1	9.042 587
2 to 5 mm	Tin, 1 kg	1	9.042 581
2 to 5 mm	Bucket, 3 kg	1	9.042 582
2 to 5 mm	Bucket, 8 kg	1	9.042 583

1 Illuminated magnifying lens Lux-50

Orange body colour, with illuminator and plastic lens.
Requires 2 x 1.5 V AA batteries for operation (included).

Lens mm	Magnification	PK	Cat. No.
Ø 50	2.5x - 5x	1	9.151 817



2 Handheld magnifier with illumination

- Hand held magnifier with magnification of 3X and 5X (depending of the view location)
- Ergonomic handle design
- Aspherical lens provides spherical aberration and distortion free images with edge-to-edge sharpness.
- LED bulb with on/off control.
- Adjustable angle of illumination.

Description	PK	Cat. No.
3X / 5X magnification	1	6.267 407



3 Magnifying lens, economic

With practical additional lens in the handle. Particularly suitable for those who require a low level of magnification. An additional high-magnification lens enables small details to be read. Transparent plastic frame ensures easy orientation on the reading material. With eyelet in the end of the handle for round-the-neck cord which is supplied. The biconvex reading magnifiers offer a large visual field in a medium magnification range. Plano-convex additional lens with 5x magnification in handle.

Lens mm	Magnification	PK	Cat. No.
Ø 65	3.0 x 7.7 dpt	1	9.151 680
Ø 80	2.3 x 5.4 dpt	1	9.151 682



4 Precision scale magnifiers

- Distortion-free image with pinpoint clarity
- Fine focusing via easy-grip focusing ring
- Supplied with standard scale, measuring range 20 mm, 1/10 mm graduation, size: diam. 23 mm
- Housing made from glass fibre reinforced polyamide
- Supplied in a solid plastic box with space for other scales

LED lighting unit for precision scale magnifiers.
- Handle holds 2 batteries (not included)

Description	Magnification	PK	Cat. No.
Magnification	10x / 40,0 dpt	1	9.151 108



5 LLG-Table-top magnifier

- Multifunctional table-top magnifier with magnification power of 2x and 4x depending of the view location.
- Can be operated with one hand
- 4 LED bulbs with on/off control.
- Magnifying lens position and illumination angle can be individually adjusted via the flexible gooseneck system
- Flicker free illumination without heat development
- Aspherical lens provides spherical aberration and distortion free images with edge-to-edge sharpness.

Description	PK	Cat. No.
2X / 4X magnification	1	6.267 406





1 USB Hand held microscope with integrated 2 megapixels camera, D-EL1 ecoline

- With integrated LED illumination and Motic application software
- Sensor CMOS 1/3"
- 2 Megapixel with USB 2.0 output
- Illumination 8-LED in ring formation with 2-step brightness control
- Power direct from computer through USB2.0 connection
- Soft-grip focus wheel
- Direct capture button
- 2 Step First Magnification 10x-50x. Second magnification at 200x (depending on screen size)
- Motic EcoLine Tool application software
- Can be used on a Mac with preinstalled application Photo Booth

Calibration slide and metal stand included.

Type	PK	Cat. No.
D-EL1 ecoline	1	9.727 034



2 Hand tally counter

Use for counting blood cells, bacterial colonies, drops of liquid, or any repetitive event. Tallies up to 9999. Features a quick-reset knob, lens window for easy reading, and finger ring for a secure grip. Sturdy, chrome-finished, metal housing. Dimensions: 46 mm diameter x 41 mm W.

Description	PK	Cat. No.
Hand tally counter	1	6.237 971



3 Superfrost® slides

According to ISO 8037/1. With colour-coded writing patch as outlined below. Size 76 mm x 26 mm. Nominal thickness 1.0 mm. With cut or ground edges. An extensive color palette allows easy and clear identification and classification of different examination preparations.

Colour	Edge finish	PK	Cat. No.
white	Cut	50	9.161 161
blue	Cut	50	9.161 162
pink	Cut	50	9.161 163
yellow	Cut	50	9.161 164
green	Cut	50	9.161 165
purple	Cut	50	6.206 284
white	Ground 45°	50	9.161 171
blue	Ground 45°	50	9.161 172
pink	Ground 45°	50	9.161 173
yellow	Ground 45°	50	9.161 174
green	Ground 45°	50	9.161 175



4 LLG-Slide dispenser

Slide dispenser can dispense 91 slides, individually. By turning the knob, one slide is dispensed. Only dry slides should be inserted into the storage magazine. With transparent, removable upper section for easy viewing of remaining slides and clean storage. For microscope slides with dimensions 75 x 25 mm and 76 x 26 mm.

Type	PK	Cat. No.
Dispenser	1	9.161 000

1 Square cover slips

Made of D263 M borosilicate glass. Accurate cutting free of flaws and blisters. Further thicknesses are available on request.

Width mm	Length mm	Thickness mm	PK	Cat. No.
15	15	0,13-0,16	200	9.161 015
18	18	0,13-0,16	200	9.161 018
20	20	0,13-0,16	200	9.161 020
22	22	0,13-0,16	200	9.161 022
24	24	0,13-0,16	200	9.161 024
26	21	0,13-0,16	100	9.161 021
32	24	0,13-0,16	100	9.161 032
40	24	0,13-0,16	100	9.161 040
46	24	0,13-0,16	100	9.161 042
48	24	0,13-0,16	100	9.161 041
50	22	0,13-0,16	100	9.161 028
50	24	0,13-0,16	100	9.161 050
60	24	0,13-0,16	100	9.161 060



2 LLG-Slide mailers

Manufactured from high density polypropylene, for shipping, storing or staining slides.

Flat mailers can hold 1, 2, 3 or 5 standard (up to 76 mm x 26 mm) slides securely.

- Light weight and flat
- With marking area and "Top" printed on top surface
- With large, easy-to secure snaps.
- Slotted channels inside mailer keep slides safely separated

To hold microscope slides	PK	Cat. No.
1	10	9.161 291
2	10	9.161 292
3	10	9.161 293
5	10	9.161 294

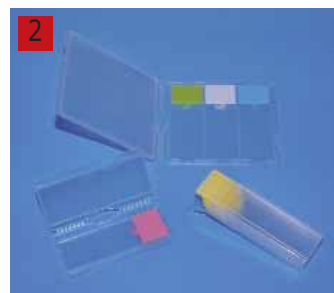

3 Slide mailers

For transporting 76 x 26 mm specimen slides, as outlined below.

To hold microscope slides	Cover type	PK	Cat. No.
2	Without	1	9.161 270



4 Microscope slide folders

Cardboard. Available with, or without, gatefold cover. For 76 mm x 26 mm slides as outlined below.

To hold microscope slides	Cover type	PK	Cat. No.
20	without	1	9.161 230
20	with	1	9.161 235



5 20- and 30-place Cardboard Slide Trays

Features thumb cut for easy slide removal.

Cardboard slide trays hold standard slides (76 mm x 26 mm and 3 x 1").

The horizontal compartments are recessed to protect the specimens when the cover is closed.

Features thumb cut for easy slide removal.

To hold microscope slides	Colour	Size	PK	Cat. No.
20	black	208 x 341 x 9 mm	1	9.161 295
30	black	281 x 328 x 10 mm	1	9.161 296
20	blue	208 x 341 x 9 mm	1	9.161 297
20	green	208 x 341 x 9 mm	1	9.161 298
20	red	208 x 341 x 9 mm	1	9.161 302





1 Microscope slide folder, Munich type

Cardboard. For 76 mm x 26 mm slides.

To hold microscope slides	PK	Cat. No.
24	1	9.161 250



2 Microscope slide tray without lid

Cardboard. For 76 mm x 26 mm slides.

To hold microscope slides	PK	Cat. No.
20	1	9.161 260

Trays for other sizes of slide are available on request.



3 LLG-Staining plates, porcelain

Rectangular, white, glazed. With cavities as outlined below.

Int. bore diam. mm	Width mm	Length mm	Cavity depth mm	Height mm	Number of cavities	PK	Cat. No.
25	81	112	4	25.0	6	1	6.232 575
17	91	115	2	17.0	12	1	6.265 001

4 LLG-Staining jars, soda-lime-glass

The Schiefferdecker Staining Jar is suitable for holding 76 mm x 26 mm slides horizontally. This staining jar has 10 grooves which can accommodate 20 slides back-to-back. The Hellendahl Staining Jar is suitable for holding 76 mm x 26 mm slides vertically. This staining jar has 8 grooves which can accommodate 16 slides back-to-back. The "Macro" Staining Jar is suitable for holding 20 slides with 76 mm x 26 mm (please order rack separately). This Stainless Steel rack for "Macro" has 20 grooves which can accommodate 20 single slides. Each staining jar is supplied with a glass lid.

Type	Width mm	Length mm	Height with cap mm	PK	Cat. No.
Schiefferdecker Staining Jar	68	88	50,15	1	9.163 250
Hellendahl Staining Jar	61	63	102	1	9.163 251
"Macro" Staining Jar	88	105	78	1	9.163 252



1 2 Digital hand-held refractometer LLG-uniREFRACTO 1 and 2

LLG-uniREFRACTO 1 and 2 are compact digital **2-scale** hand refractometers for measuring the sugar content and refractive index of liquids. Easy switch from **Brix to RI scale**.

Calibrate simply with distilled water. Easy to clean under running water due to waterproof housing (IP 65). Automatic temperature correction and sample plate made of stainless steel, on both models.

Two models with different measuring ranges are available:
LLG-uniREFRACTO 1 from 0 - 54 % Brix and 1.33 - 1.42 RI
LLG-uniREFRACTO 2 from 0 - 95 % Brix and 1.33 - 1.54 RI

Specifications

Resolution:	0.1 % Brix/0.0001 RI
Accuracy:	±0.2 % Brix/±0.0003 RI
Operating temperature:	5 to 40 °C
Measuring temperature:	5 to 60 °C
Rel. Humidity:	<95 %
Protection class:	IP 65
Warranty:	3 years

Type	PK	Cat. No.
LLG-uniREFRACTO 1	1	6.263 630
LLG-uniREFRACTO 2	1	6.263 631



3 Precision refractometers, basic model

Simple and precise optical instruments to analyse liquids and their solid contents. Models are equipped with an automatic temperature compensation device (ATC). Supplied with a plastic box and comfortable leather-type case.



Type	For	Measuring range	Accuracy	PK	Cat. No.
RGA/ATC	Alcohol	0 - 80 % Vol	1 % Vol	1	9.801 256
RBB/ATC	Wine	0 - 25 % Vol	0,2 % Vol	1	9.801 255
		0 - 22° Be'	0,2° Be'		
		0 - 40 % Brix	0,2 % Brix		
RBO/ATC	Wine	0 - 140 ° Oe	1° Oe	1	9.801 254
		0 - 25° Babo	0,2° Babo		
		0 - 32 % Brix	0,2 % Brix		
RMB/ATC	Wine	0 - 25 % Vol	0,2 % Vol	1	9.801 253
		0 - 20° Be'	0,2° Be'		
RMA/ATC	Wine	0 - 25 % Vol	0,2 % Vol	1	9.801 252
		0 - 40 % Brix	0,2 % Brix		
RPC/ATC	Freezing point	-50 - 0 °C	5°C	1	9.801 251
	batteries	1,10 - 1,40	0,1		
RCS/ATC	Salinity	0 - 28 ‰	0,2 ‰	1	9.801 250
RSM/ATC	Salinity	0 - 100 ‰	1 ‰	1	9.801 249
RCZ/ATC		0 - 32 % Brix	0,2 %	1	9.801 200
RTS		0 - 90 % Brix	0,2 %	1	9.801 201
RPI/ATC	Biological fluids: urine, serum	0 - 12 g/dl	0,2 g/dl	1	9.801 202
		1,000 - 1,050 sg	0,002 sg		
		1,3330 - 1,3600 nD	0,00025 nD		
RBC/ATC		0 - 10 % Brix	0,1 %	1	9.801 241
RLC/ATC		0 - 18 % Brix	0,1 %	1	9.801 242
RFC/ATC		28 - 62 % Brix	0,2 %	1	9.801 244
RPD/ATC		45 - 82 % Brix	0,5 %	1	9.801 245
RPU		0 - 80 % Brix	1%	1	9.801 246
RMM/ATC	Honey and jam	58 - 90 % Brix	0,5 % Brix	1	9.801 247
		38 - 43° Be'	0,5° Be'		
		17 - 27 water	1 % water		

Spectrophotometer LLG-uniSPEC 2 and 4

High-quality and cost-efficient UV/VIS spectrophotometers for pharmaceutical, biochemical and clinical lab applications. Suitable for different measurement types such as kinetics, wavelength scans, quantitative analysis, multi-wavelength and DNA/Protein analysis.

Available in two versions:

LLG-uniSPEC 2 for standard routine measurements and uniSPEC 4 suitable for complex measurements e.g. required for quality controls. LLG-uniSPEC 4 features a small band width and a high wavelength accuracy. Both units can store and save 200 calibration curves. A pre-adjusted lamp design allows a fast and easy lamp replacement. Both lamps can be individually turned on/off to extend the durability. Both versions can be used either as stand-alone units or can be operated via a PC by using the supplied software.

- Single beam system, grid with 1200 lines/mm
- Silicon photodiode detector
- Parallel port for printer output
- USB port
- 4 position cell holder (10 mm) included
- Additional cell holders optionally available
- LCD display
- Deuterium and tungsten lamp
- Automatic wavelength adjustment

Scope of delivery: LLG-uniSPEC 2 or 4 Photometer, software for connection to PC, 4 glass cells and 2 quartz cells.



6.263 610

Specifications

Optical System:	Single beam, Grating 1200 lines/mm, Silicium photodiode detector
Wavelength range:	190 to 1100 nm
Bandwidth:	2 nm // 1.8 nm
Wavelength accuracy:	±0.5 nm // ±0.3 nm
Wavelength repeatability:	0.3 nm // 0.2 nm
Wavelength setting:	automatic
Photometric accuracy:	±0.5 % T // ±0.3 % T
Photometric repeatability:	0.3 % T // 0.2 % T
Photometric range:	-0.3-3 A, 0-200 % T, 0-9999 C
Stability:	±0.002 A/h at 500 nm
Stray light:	≤0.1 %T // ≤0.05 %T at 220 nm, 360 nm
Data output:	USB port
Printer port:	parallel port
Display:	128 x 64 Dots LCD // 320 x 240 Dots LCD
Standard cell holder:	4-position 10 mm cell changer
Lamps:	D2 lamp and W lamp
Dimension (W x D x H):	460 x 360 x 225 mm // 625 x 430 x 206 mm
Weight:	18 kg // 28 kg
Power supply:	220 V/50 Hz or 110 V/60 Hz
Warranty:	3 years

LLG-uniSPEC 2 // LLG-uniSPEC 4



6.263 620

Type	PK	Cat. No.
LLG-uniSPEC 2 with EU-plug	1	6.263 610 1
LLG-uniSPEC 2 with UK-plug	1	6.263 611
LLG-uniSPEC 4 with EU-plug	1	6.263 620 2
LLG-uniSPEC 4 with UK-plug	1	6.263 621

Accessories for Spectrophotometer LLG-uniSPEC 2 and LLG-uniSPEC 4

Description	PK	Cat. No.
Cuvette holder for 4 cuvettes 50 mm and 100 mm	1	6.266 530
Cuvette holder for 4 cuvettes 100 mm	1	6.266 531
Tungsten lamp	1	6.263 615
Deuterium lamp	1	6.263 616
Thermo printer	1	6.263 614

1 LLG-Disposable plastic cells, PS

The shape and narrow wall thickness of the cuvettes enable an excellent heat transfer resulting in constant sample temperatures during photometric measurements.

- Cavity sorted
- Glass clear polystyrene (PS)
- Applicable wavelength range 340 nm to 900 nm
- Very low variation of extinction values
- Excellent optical transmission range
- Path length 10 mm
- Overall dimensions 12.5 mm x 12.5 mm x 45 mm
- Styrofoam racks: 100 cuvettes in a styrofoam box with cover

1



Description	Capacity	Path length mm	Operating range nm	Material	PK	Cat. No.
	ml					
Macro	4.0	10.0	340 to 900	PS	100	9.406 011
Semi-micro	1.6	10.0	340 to 900	PS	100	9.406 012

2 Cuvette rack, PP

Grey. 16 numbered positions.
Autoclavable (121 °C).

Width mm	Length mm	Height mm	PK	Cat. No.
70	210	38	1	9.145 020

2



3 Cuvette rack with attached lid, PP

For safe handling and holding up to 12 cuvettes with a 10 mm light path. These racks consist of hinged lids with secure clasps and removable inserts for easy cleaning. The height of the lid is designed to accommodate all spectrophotometer cells - even those with covers or stoppers.

Description	PK	Cat. No.
Cuvette rack with attached lid	1	6.267 353

3



1



9.413 216

LLG-Dispenser system for moist cloths Wiper Bowl® Safe & Clean

The economical "building block solution" for thorough disinfection and cleaning of sensitive areas in the medical and foodstuff industries. Can be filled with all commercial disinfectant and cleaning agents. The fine perforated structure of Multitex® moist cloths ensures an even distribution of the surface disinfectant. These moist towels are also ideally suited to the cleaning of grossly soiled surfaces. Easy handling thanks to tear-off perforation. After cleaning the lid can be closed and the tissues stay moistured for more than 30 days ensuring a constant cleaning and disinfection performance.

LLG-Dispenser bucket Wiper Bowl® Safe & Clean:

Empty. For 1 roll Multitex® DR. Made of plastic, dia. approx. 21 cm, resealable and reusable.

LLG-Cleaning tissues Multitex® DR:

Viscose fleece for LLG-Dispenser bucket Wiper Bowl® Safe & Clean.

White, fine, tear-resistant, absorbent and lint free.

Dimensions: 300 mm x 320 mm.

1 roll of 90 tissues

Please order separately.

2



9.413 215

Type	PK	Cat. No.
LLG-Dispenser bin	1	9.413 216 1
LLG-Cleaning tissues Multitex® DR	1	9.413 215 2

3



3 Cleaning Office, technical cleaning cloths with alcohol

Moist, non-woven cloths in a re-sealable dispensing pack. For the cleaning of, and caring for, all office equipment. With antistatic and disinfectant action.

Dimensions: 138 mm x 190 mm

Shelf life: unopened, 30 months without loss of quality

Package contents	PK	Cat. No.
Dispensing pack of 100 tissues	1	9.190 977
Refill pack of 100 tissues	1	9.190 976

4



4 Dust remover spray DRUCKLUFT 67

Compressed air spray for contact-free removal of dust and dirt in hard-to-reach places using the capillary tube nozzles attached. Safe, clean, oil-free. Acc. to Aerosol policy 75/324/EWG no danger of inflammation or explosion when using as intended. DRUCKLUFT 67 contains pure and dry compressed gas and is very efficient.

Examples of use:

photography, precision electronics, watchmaking, cameras, medical technology, microscopy, research.

Pressure: 4.2 bar (20 °C)
Density: 1.00 g/cm³ (20 °C)

Description	Capacity ml	PK	Cat. No.
Dust remover spray	200	1	9.412 800
Dust remover spray	400	1	9.412 801

5



5 Dust remover spray Druckluft 67 SUPER

Spray for the contact-free removal of dust and dirt from hard-to-reach places. For highest safety also for devices under electric tension. Acc. to Aerosol policy 75/324/EWG no danger of inflammation or explosion even in the presence of ignition sources. DRUCKLUFT 67 SUPER contains pure and efficient compressed gas. Especially suitable for work under electric tension and for ex-use.

Examples of use:

photography, precision electronics, watchmaking, cameras, medical technology, microscopy.

Pressure: 4.6 bar (20 °C)
Density: 1.17 g/cm³ (20 °C)
Gas volume: 400 ml can produces 116 L gas at 20 °C and 1 bar.

Capacity ml	PK	Cat. No.
400	1	9.412 805

Label solvent - please see page 41.

1 2 3 LIG-Laboratory and hygienic tissues, 2-ply, 150 wipes

Laboratory and hygienic tissues in dispenser box
 - contains 150 white, double-ply tissues, 210 mm x 220 mm
 - highly absorbent and ultra-soft
 - for sensitive application areas

Carton of 30 boxes with 150 wipes

Wall Mount, wire, white-coated with wall mounting material for packaging up to 70 mm depth, please order separately.

Package contents	PK	Cat. No.
Carton of 30 boxes with 150 wipes	30	9.413 220

1



2



3



4 5 6 7 Universal dishwashing

Universal cloth:

Made from 80 % viscose and 20 % polyester. The universal cloth has a finely structured surface. It provides a cleaning result without streaks, is nearly lintfree and washable up to 95 °C. Please wash in lukewarm water before first use.

Washing up liquid:

HS citro is a dish washing detergent for universal implementation with a fresh fragrance for porcelain, glass, plastic, and metal. Professional recipe with high grease dissolving strength and plant-based skin protecting additives. 1L

Sponge:

For cleaning any kind of incrustation.

Gloves:

Natural rubber. Excellent finger sensitivity, high flexibility. Flock-lined for optimal comfort. Special surface finish provides a firm hold. Good resistance to ketones and many acids. L 305 mm.

Description	Colour	Dimensions mm	PK	Cat. No.
Universal cloth	blue/white	380 x 380	10	6.266 668
Universal cloth	red/white	380 x 380	10	6.266 669
Universal cloth	green/white	380 x 380	10	6.266 670
Universal cloth	yellow/white	380 x 380	10	6.266 671
Sponge	green/yellow	150 x 90 x 40	10	6.266 672
Sponge	green/yellow	95 x 70 x 45	10	6.266 673
Washing up liquid, 1L			1	6.266 678

4



5



6



7



8 Wipes Unitex®

Made from cellulose and polyester fibers, turquoise.

- Without binders, chemicals or adhesives
- Resistant to solvents and silicone free
- Particularly tear-resistant and lintfree
- Useable dry and wet, high absorption capacity
- Excellent for cleaning and degreasing surface

8



Width mm	Length mm	Thickness mm	Weight g / m ²	Package contents	PK	Cat. No.
380	300	0.28	68	pack of 4 x 50 tissues	4	6.266 676

Cleaning implements/Wipes, cloths

1

1 LLG-Laboratory tissues, roll, 102 sheets 3-ply

Roll with 102 sheets (220 x 260 mm).
 - strong when wet
 - absorbent
 - low lint

Package contents	PK	Cat. No.
roll of 102 tissues	2	9.413 224
roll of 102 tissues (advantage pack)	28	9.413 225

2

2 Wipes Multiclean®, 3-ply

Handy cleaning cloths, resistant and with high wet strength they are ideal for light and coarse dirt work. The appropriate holder, whether as floor stand or for wall mounting are available on request.

Width mm	Length mm	Weight g / m ²	Package contents	PK	Cat. No.
220	380	60	2 rolls with 500 tears	2	7.618 013
380	380	54	2 rolls with 500 tears	2	7.618 212
360	360	54	Roll with 1000 tears	1	7.671 903

3

6.266 675

3 Multitex® roll Ultra z 70, white, disposable tissues

The high-quality viscose fleece with textile characteristics is suitable for wet and dry cleaning thanks to its incredible strength. The cloths are very soft and yet lint-free, they can absorb large amounts of liquid and remain tear-resistant, they are solvent-resistant and they meet food safety requirements. Silicone free.

Width mm	Length mm	Thickness mm	Weight g / m ²	Package contents	PK	Cat. No.
410	380	0.36	80	roll with 500 tears	1	6.266 675 3
350	300	0.36	80	12 bags of 76 tissues	12	6.266 674 4

4

6.266 674

5

5 Unitex®, roll, turquoise disposable tissues

Unitex® cleaning cloth from cellulose and polyester fibers.
 - Without binders, chemicals or adhesives
 - Resistant to solvents and silicone free
 - Particularly tear-resistant and lintfree
 - Useable dry and wet, high absorption capacity
 - Excellent for cleaning and degreasing surface

Width mm	Length mm	Thickness mm	Weight g / m ²	Package contents	PK	Cat. No.
390	325	0.28	68	roll with 500 tears	1	6.266 677

Roll holders

Description	PK	Cat. No.
Floor stand with waste bag holder for rolls up to 42 cm width	1	6.266 990 6
Wall bracket with waste bag holder for rolls up to 42 cm width	1	6.266 991 7

6

6.266 990

7

6.266 991

1 LLG-Hand towels, 3-ply

Bright white, extra absorbent, completely unfolding, matching with most dispenser systems, economic use by high absorbancy and comfortable size. Suitable for LLG-Dispenser for hand towels, Cat No 7.618 375.

Width	Length	Package contents	PK	Cat. No.
mm	mm			
220	420	20 Packs with 100 tissues	20	6.266 568



2 LLG-Hand towel dispenser

White plastic, easy to refill, with window to observe the filling level, suitable for towel up to 245 mm width, e.g. Cat. No. 6.266 568.

Width	Depth	Height	PK	Cat. No.
mm	mm	mm		
280	137	375	1	7.618 375



3 LLG-Cellulose tissue, supplied in stacks

- Unbleached or highly bleached
- Pack quantity: 1 x 5kg

Description	Width	Length	PK	Cat. No.
	mm	mm		
unbleached	600	400	1	9.413 210
highly bleached	600	400	1	9.413 211



4 Cotton wool roll

- 100 % Cotton
 - White cotton - bleaching with Hydrogen Peroxide (non chlorine-bleached and without fluorescent whitening agent)
 - according to European Pharmacopoeia & Ecotex 100 Certificate, respond to the maximum rate Standards of Biobinden (100 cfu/g)
 - Width - Max. 25 cm, length ±7 m (500 g)
- For absorbent cotton roll:
- highly absorbent
 - Tenacity of water : appr. 23 g/g of cotton

Description	PK	Cat. No.
Cotton roll 500 g, absorbent	1	9.413 155
Cotton roll 500 g, non-absorbent	1	9.413 156



5 Cotton wool

Meets requirements of German Pharmacopoeia.
100% cotton.
Medical cotton wool for home use and general hygiene.

Capacity	PK	Cat. No.
g		
100	1	9.413 152
400	1	9.413 151



Brushes, natural bristle

Type	Diam. mm	Length mm	PK	Cat. No.
Pipette brush	5	480	1	9.019 010 1
Pipe cleaner	4	150	100	9.019 005 2
Reagent bottle brush with wool tip	10	190	1	9.019 020
Reagent bottle brush with head bundle	10	250	1	9.019 030 3
Reagent bottle brush with wool tip	15	280	1	9.019 035 4
Reagent bottle brush with wool tip	30	270	1	9.019 040
Erlenmeyer flask and bottle brush with head bundle	50	340	1	9.019 050
Erlenmeyer flask and bottle brush with head bundle	63	470	1	9.019 060
Beaker brush with wooden handle	85	390	1	9.019 070 5
Beaker brush with wooden handle	85	430	1	9.019 080
Beaker brush with wooden handle	80	430	1	9.019 090
Beaker brush with extra long wooden handle	80	630	1	9.019 092
Rinsing brush**	60	220	1	9.019 110 6
Set*			1	9.019 002
Hinge glasses brush bristled, with hinge		440	1	6.237 788
Replacement head for hinge glasses brush		43	1	6.266 904
Burette brush with 1m long wire handle	30	1000	1	9.019 100

* Set consisting of order numbers 9.019 010, 9.019 020, 9.019 030, 9.019 040, 9.019 050, 9.019 060, 9.019 070, 9.019 080, 9.019 090 and 9.019 092.

**Nylon



7 Cleaning brushes

Pack of 10.

Brush with swivel head, head 21 mm x 44 mm x 24 mm for vessels with NS 29/32 or diam. 24 mm, Length: 450 mm

Description	PK	Cat. No.
Brush with swivel head, head 21 mm x 44 mm x 24 mm	10	6.242 423



8 LLG-Cleaning brushes

Excellent tools for washing and cleaning of all types of laboratory bottles, flasks, tubes, condensers, burettes, etc. Brush material is manufactured from highest quality of fibre/perlon for long life cycle. Brush stem is manufactured from corrosion proof twisted steel wire. Brush handle is manufactured from polypropylene and offers extreme easy handling and use of the brush. Unique handle design enables hanging of the brush to a convenient place for easy reach. Spherical sponge, top part enables access to every corner of the labware and guarantees perfect cleaning results.

For	Description	Length mm	Figure	PK	Cat. No.
burettes and tubings	LLG-Cleaning brush 20 x 125 mm	845	a	10	6.267 293
large size bottles	LLG-Cleaning brush 70 x 130 mm	460	b	10	6.267 294
medium size bottles	LLG-Cleaning brush 50 x 110 mm	460	c	10	6.267 295
small size bottles	LLG-Cleaning brush 40 x 110 mm	380	d	10	6.267 296
test tubes	LLG-Cleaning brush 25 x 100 mm	295	e	10	6.267 297
narrow test tubes	LLG-Cleaning brush 12 x 80 mm	235	f	10	6.267 298

1 Hair brushes, oval

Black goat hair. In metal mounts on round wood handle.

Size	Diam. mm	PK	Cat. No.
0	6	1	9.172 025
1	7	1	9.172 026
2	8	1	9.172 027



2 Hair brushes, broad

Bear bristle. Blunt head. Flat stem.

Width mm	Hair length mm	Wall thickness mm	PK	Cat. No.
12.5	16	3.9	1	9.172 042
19.0	18	3.9	1	9.172 043
25.4	22	4.1	1	9.172 044



3 Red marten-hair brushes

Silver ferrule. Black enamelled round handle.

Size	Hair length mm	PK	Cat. No.
0	8	1	9.172 050
1	9	1	9.172 051
2	11	1	9.172 052
3	13	1	9.172 053
4	15	1	9.172 054
5	18	1	9.172 055
6	19	1	9.172 056



4 LLG-Weighing brush, with wooden handle

Fine hair weighing brush with pointed tips and wooden black handle.
Excellent tool for cleaning of weighing boats, weighing dishes and analytical balances.

Description	PK	Cat. No.
LLG-Weighing brush	1	6.267 404



5 Balance brush

Oval. Size 2/6 mm, size 4/9 mm and size 6/12 mm

Type	Size	Diam. mm	PK	Cat. No.
Brush	2	6	1	6.266 807
Brush	4	9	1	6.074 169
Brush	6	12	1	6.266 808
Brush set*	2, 4, 6		1	6.266 825

*consisting of one brush each size 2/6 mm, size 4/9 mm and size 6/12 mm

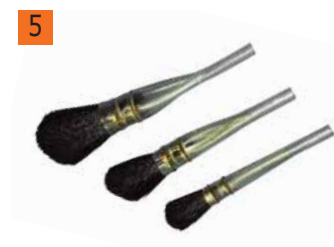

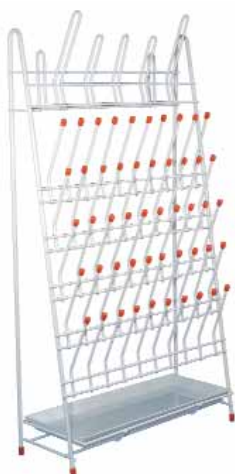
1

1 LLG-Draining racks, PE-coated wire

Wall or bench mounting for 50 reagent bottles and 5 flasks
 With drip channel and plastic covered feet.
 Dimensions (L x W x H): 360 x 130 x 650 mm.

Description	PK	Cat. No.
For 50 reagent bottles and 5 flasks	1	6.281 619

2

2 Indicator tape for steam, hot air and gas sterilisation

Crepe paper, adhesive. With indicator. Colour changes according to DIN EN ISO 11140-1.
 Rolls of 50 m.

With	colour change	Width mm	Figure	PK	Cat. No.
Steam indicator, lead free	green / black	18	a	1	9.140 787
Steam indicator, lead free	green / black	24	a	1	9.140 788
Steam indicator	white / brown	19	b	1	9.140 784
Steam indicator	white / black	25	b	1	9.140 789
Hot air indicator	green / brown	19	e	1	6.240 223

3

6.272 288

Steam Indicator Strips

Class 4 Multi-Variable Steam Indicator Strips

Class 4 Multi-Variable Steam indicator strips are designed to be used in steam sterilizers operating at 134 °C -3.5 minutes. The indicator strips can be used in every pack and will provide assurance of steam penetration into the packs. The water based and non-toxic chemical indicator in compliance with ISO 11140-1 will show a clear and accurate color change from blue to black after successful steam sterilization. PMSSteriTest indicator strips are cost effective and can be divided into two separate pieces for more economical use.

- Dual Strip design
- Designed for STEAM sterilization at 134 °C - 3.5 minutes.
- Water based, non-toxic chemical indicator comply to ISO 11140-1
- Clear and accurate color change from blue to black
- Manufactured in absence of lead or other heavy metals

Class 6 Emulating Steam Indicator Strips

Class 6 Emulating Steam indicator strips are designed to be used in steam sterilizers operating at 121 °C -15 minutes and 134 °C -3.5 minutes. The cycle verification indicators can be used in every pack and will provide assurance of steam penetration into the packs and presence of all critical parameters of steam sterilization cycle.

The water based and non-toxic chemical indicator in compliance with ISO 11140-1 will show a clear and accurate color change from blue to lilac after successful steam sterilization.

- Single Strip design
- Designed for STEAM sterilization at 134 °C - 3.5 minutes.
- Designed for STEAM sterilization at 121 °C - 15 minutes.
- Water based, non-toxic chemical indicator comply to ISO 11140-1
- Clear and accurate color change from blue to lilac
- Manufactured in absence of lead or other heavy metals

4

6.272 289

Description	Package contents	PK	Cat. No.
Steam Indicator Strips (Class 4)	1 x 500	1	6.272 288 3
Steam Indicator Strips (Class 6)	1 x 250	1	6.272 289 4

➔ Disposal bags - please see page 65.

1 Bowie-Dick Test Pack

These Bowie-Dick Test Packs are pre-assembled, single use test packs designed to evaluate the performance of the air removal system of pre-vacuum assisted sterilisers in compliance with EN 285 and operating at 134 °C and 3.5 minutes. An indicator sheet printed with water based, non-toxic chemical indicator is placed in the center of each pack. The uniform colour change of the indicator after steam sterilisation indicates that all air was removed and replaced by steam. The backside of the indicator sheet contains fields to be filled out and it can be kept as a permanent record for traceability purposes.

- Disposable, pre-assembled and ready to use test packs
- Designed for STEAM sterilization at 134 °C - 3.5 minutes.
- Clean and accurate indicator color change
- Indicator sheet can be kept as a permanent record
- Validated for 4 kg and 7 kg sterilisation load
- Manufactured in absence of lead or other heavy metals



Description	PK	Cat. No.
Bowie-Dick-Test (4 kg)	48	6.272 290
Bowie-Dick-Test (7 kg)	24	6.272 291

2 Self-Seal Sterilization Pouches

Self-seal sterilization pouches are pre-folded and assure accurate and fast closing without the requirement of a heat sealing device. They are especially suited for use in small general practices, dental surgeries and by users who want to avoid costs of additional sealing equipment. The self-seal sterilization pouches are constructed from transparent PET/PP multi-layer copolymer film, medical grade paper and adhesive strip which provides excellent resistance to over-exposure of steam and clean opening. Water based, non-toxic process indicators for steam and ethylene oxide sterilization complying with ISO 11140-1, ISO 11607 and EN 868-5 are applied on the paper surface and help to differentiate between processed and unprocessed packages.

- Reinforced film to avoid tearing during opening
- Clean and accurate indicator color change
- Tear, fibre-free opening and aseptic presentation
- Triple band seal for higher package integrity



Dimensions mm	PK	Cat. No.
75 x 200	200	6.272 280
90 x 230	200	6.272 281
90 x 270	200	6.272 282
130 x 290	200	6.272 283
190 x 340	200	6.272 284
300 x 430	200	6.272 285



Heat-Sealable Sterilization Pouches and Reels

Heat-sealable sterilisation pouches and reels as a packaging solution for sterilisation applications, ensure reliable protection of the medical device against contamination with bacteria from the time of sterilisation until use of the sterile medical device. Flat and gusseted type and wide range of standard sizes allow optimum choice of correct sized packaging of each item. The sterilisation reels and pouches are constructed from transparent PET/PP multi-layer copolymer film and medical grade paper. Water based, non-toxic process indicators for steam and ethylene oxide sterilisation (complying with ISO 11140-1) are applied on the paper surface. This helps differentiating between processed and unprocessed packages. Sterilisation reels and pouches are proven microbial barriers and comply to ISO 11140-1, ISO 11607 and EN 868-5 standards.

- Reinforced film to avoid tearing during opening
- Clean and accurate indicator colour change
- Tear, fibre-free opening and aseptic presentation
- Triple band seal for higher package integrity

The sterilisation pouches and reels are effective barriers against germs and according the requirements of ISO 11607, EN 868-5 and ISO 11140-1 standards.



1 Heat-Sealable Sterilization Pouches

Description	Dimensions mm	PK	Cat. No.
flat	75 x 200	1000	6.272 268
flat	100 x 300	1000	6.272 269
flat	150 x 400	1000	6.272 270
flat	200 x 450	1000	6.272 271
flat	250 x 400	1000	6.272 272
flat	250 x 500	1000	6.272 273
flat	300 x 500	1000	6.272 274
gusseted	100 x 300	1000	6.272 275
gusseted	150 x 390	1000	6.272 276
gusseted	200 x 500	500	6.272 277
gusseted	250 x 500	500	6.272 278
gusseted	300 x 600	500	6.272 279



2 Heat-Sealable Sterilization Reels

Description	Width mm	Length m	PK	Cat. No.
flat	50	200	1	6.272 250
flat	75	200	1	6.272 251
flat	100	200	1	6.272 252
flat	150	200	1	6.272 253
flat	200	200	1	6.272 254
flat	250	200	1	6.272 255
flat	300	200	1	6.272 256
flat	350	200	1	6.272 257
flat	400	200	1	6.272 258
flat	500	200	1	6.272 259
gusseted	75	100	1	6.272 260
gusseted	100	100	1	6.272 261
gusseted	150	100	1	6.272 262
gusseted	200	100	1	6.272 263
gusseted	250	100	1	6.272 264
gusseted	300	100	1	6.272 265
gusseted	350	100	1	6.272 266
gusseted	400	100	1	6.272 267

1 Roll dispenser with Cutter

The dispenser frame is made of stainless steel and steel rods with nylon bearings for hygienic use at CSSDs. The integrated cutting unit includes an accurate and high quality cutting blade, providing safe and secure handling, as well as easy replacement. The roll dispenser and cutter is an useful addition to rotary sealing machines. It's renewed and the modular design makes it an ergonomic and economic tool which can be used as single or double rack model on working stations or just mounted on the wall.

Description	PK	Cat. No.
Roll dispenser with cutter	1	6.272 287



2 Rotary Sealer

This Rotary Sealer is an entry model which is solid, durable and extremely easy to use. Once power is on and the variable temperature adjustment has been done, the Rotary Sealer works when it's needed and stops automatically when the work is done. The basic rotary sealer is microprocessor controlled and the temperature can be adjusted anytime easily. The sensitive temperature ranging between 50 °C and 250 °C provides the user with flexibility to seal different kinds of packaging such as paper/film and Tyvek pouches. Automatic feeding driven by optical sensors and multiline sealing technique ensure optimum seal strength at continuous operations. This sealing system is validated, calibrated and in compliance with international standards.

Description	Dimensions (W x D x H) mm	PK	Cat. No.
Rotary Sealer	230 x 510 x 170	1	6.272 286

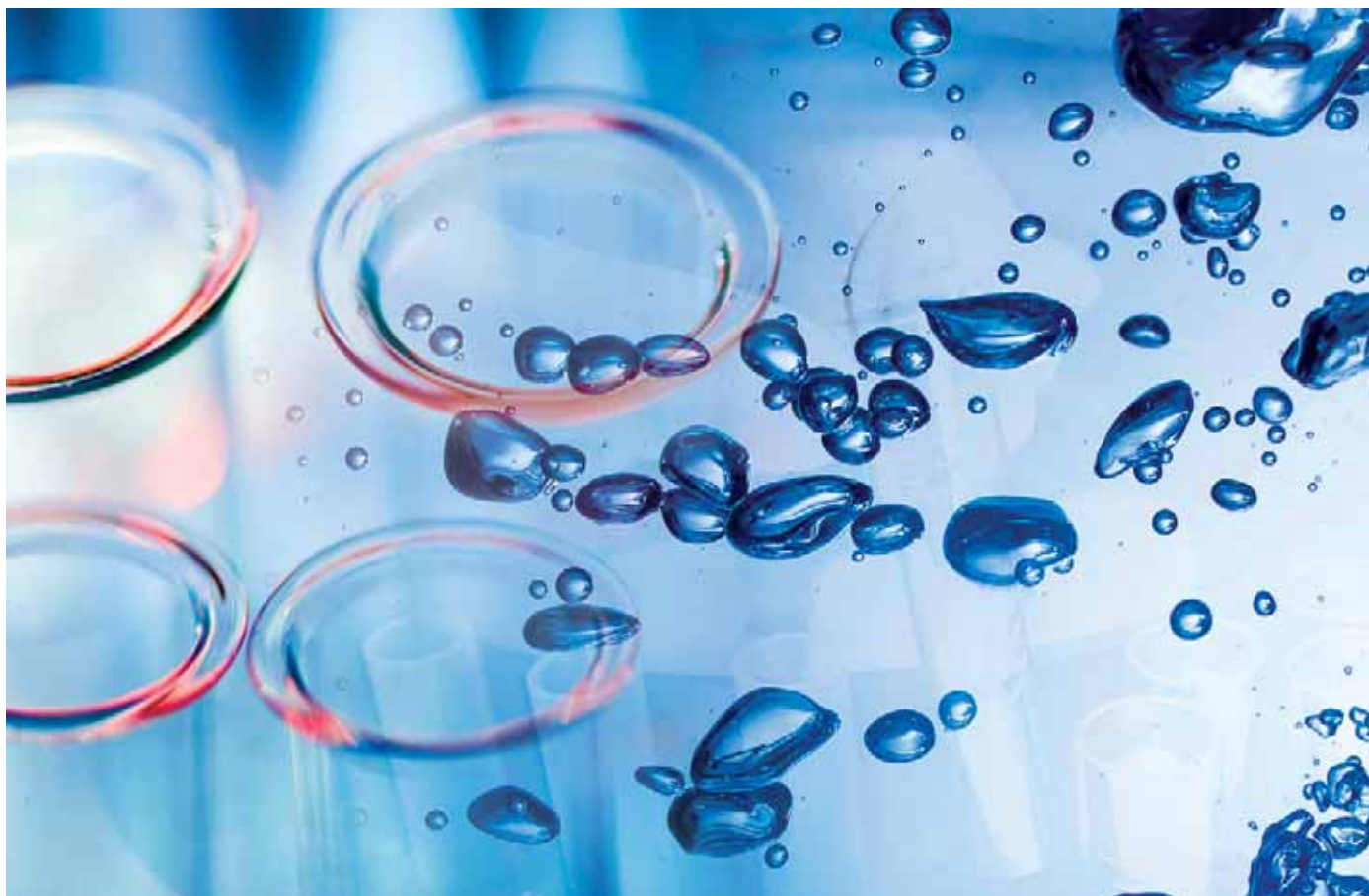

1 LLG Photometers PrimeLab 1.0

The first and only photometer using just one LED and one (JENCOLOR) sensor, simultaneously covering 400 wavelengths in one go.

The JENCOLOR sensor allows self-calibration of the unit in seconds.

More than 100 test methods are available to be individually selected when device is purchased. User can choose to either use tablet, liquid or powder reagents. Users can create and export test reports per "account" via software and/or App, where it also can store individual water treatment chemicals to create dosage recommendations. Using the PrimeLab adapter for Turbidity (NTU), PTSA and Fluorescein, even those parameters can be tested by the PrimeLab whereas user normally needs to purchase a second device. View a full range of available test information can be found at www.primelab.org.

PrimeLab 1.0 Multitest Photometer BASIC-KIT 3-in-1 (Chlorine/pH/Chlorine dioxide):

ID11 - Chlorine (free/combined/total) using DPD tablets

ID16 - Chlorine dioxide using DPD tablets

ID38 - pH using Phenol Red tablets

Reagent tablets to do 50 tests

More combinations of measurement methods on request.

PrimeLab 1.0 Multitest Photometer ALL-IN-KIT (all current and future parameters activated):

Contains the measurement methods of BASIC-SET and same content as basis (over 100 parameters).

All available parameters are activated on the device and will be automatically added and activated while performing an update through PC-software or App.

Please order reagents separately.

Specifications:

Optic:	JENCOLOR Multispectral sensor, covering 380-780 nm
Power:	4 x AAA batteries/5.0 V DC-adaptor
Size:	180 x 90 x 60 mm
Weight:	160 g
Communication:	Bluetooth
Connection:	Free PC software (windows) "PrimeLab Desktop Assistant" and free Android/iOS/Windows App
Time/date:	Real Time Clock with date and auto-off
Display:	LCD (monochrome)
Calibration:	Auto-calibration function
One-Time-Zero:	Intelligent OTZ, based on chosen method
Memory:	On device: 20 accounts/100 test results
Environment:	30-80 % RH (non-condensing), ca. 5-45 °C
Warranty:	3 years

Description	PK	Cat. No.
BASIC-KIT 3-in-1, Photometer	1	6.268 024
Photometer ALL-IN-KIT	1	6.268 025



Accessories for Photometers PrimeLab 1.0

Description	PK	Cat. No.
Set of 10 x 10 ml glass-vials	10	6.268 026
adapter to use 16 mm vials on PrimeLab (e.g.: for COD vials)	1	6.268 033
Adapter-kit "Turbidity"	1	6.268 038
Adapter-kit "PTSA"	1	6.268 039
Adapter-kit "Fluorescein"	1	6.268 040
Reference solution "ZERO, Chlorine, pH, Cyanuric Acid (tablet reagents)"	1	6.268 041
Reference solution "ZERO, Chlorine, pH, Cyanuric Acid (liquid reagents)"	1	6.268 042
Reference solution (10ml each) 0,5 / 10 / 1000 NTU	1	6.268 043
Reference solution (100ml each) "100 µg/l PTSA" and aqua dest	1	6.268 044
Reference solution (100ml each) "100 µg/l Fluorescein" and aqua dest	1	6.268 045

1 Imhoff Sedimentation cones, borosilicate glass 3.3

Manufactured from borosilicate glass 3.3 according to sedimentation tests according to DIN 12672 standard. Featured with volume graduation of 1000 ml. Volume graduations and inscriptions are printed with white enamel.

Graduations, ml:	Subdivisions ml:
0 to 2	0.1
2 to 10	0.5
10 to 40	1.0
40 to 100	2.0
100 to 1000	50.0

Type	PK	Cat. No.
without stopcock	1	6.286 841 1
with stopcock	1	6.286 842 2



6.286 841

6.286 842

3 Sedimentation cone, plastic, SAN

Imhoff pattern. DIN 12672. Transparent SAN (Styrene acrylonitrile). With screw cap for draining the contents. Temperature-resistant up to max. 85 °C.

Graduations, ml:	Subdivisions, ml
0 to 2	0.1
2 to 10	0.5
10 to 40	1
40 to 100	2
100 to 1000	50

Type	Grad.	PK	Cat. No.
With screw cap	ml up to 1000	1	9.304 280



4 Stands for Imhoff cones, PMMA/steel

Manufactured to hold two Imhoff sedimentation cones of any type. Compact design allows easy carry of imhoff cones even when the cones are filled. The unique designs provide easy carry of all types of Imhoff cones with or without stopcock.

Type	PK	Cat. No.
Stands for Imhoff cones	1	6.286 843



5 Sedimentation cones, accessory stand, Acrylic/PP

Acrylic/PP. To hold two Imhoff sedimentation cones. Compact and easy to transport even when fully loaded.

Width mm	Length mm	Height mm	PK	Cat. No.
150	300	300	1	9.304 281



LLG-PCR Tubes and Plates, PP

- Premium quality
- Produced in a cleanroom environment
- RNase-, DNase-, Human DNA- and Pyrogen-free
- Virgin Polypropylene
- Compatible with all major thermocyclers



1 LLG-PCR tubes with attached lids, PP

- Individual tubes
- Compatible with all major thermocyclers
- 0.2 ml or 0.5 ml
- Maximum tube capacity: 0.25 ml or 0.6 ml when closed
- Individual attached flat or domed snap caps
- Consistent wall thickness for uniform heat transfer
- Cap design ensures fit and helps reduce sample evaporation
- Virgin polypropylene, certified RNase, DNase and endotoxin free

Description	PK	Cat. No.
0.2 ml, single, flat cap	1000	9.407 501
0.2 ml, single, domed cap	1000	9.407 502
0.5 ml, single, flat cap	1000	9.407 504
0.5 ml, single, domed cap	1000	9.407 505

LLG-PCR-Tubes, 8 Strips with attached individual caps, PP

- for 0.2 ml Thermocycler blocks
- with flat or domed cap
- made of high quality polypropylene, RNase-, DNase- and Endotoxin free

Description	PK	Cat. No.
8 PCR tube strips with individually attached flat snap caps	250	9.407 515 2
8 PCR tube strips with individually attached domed ultra clear snap caps	250	9.407 516 3



LLG-PCR-Tubes, 8 Strips, PP

- For 0.2 ml thermocycler blocks
- Detached cap strips can be used as individual tubes when cut
- With domed or flat caps
- Consistent wall thickness for uniform heat transfer
- Contamination-free opening
- Cap strips provide tight seal during all PCR cycles
- Easy-to-use
- Maximum tube capacity: 0.25 ml when closed
- Highly transparent cap makes them ideal for qPCR
- Virgin polypropylene, certified RNase, DNase and endotoxin free

Description	PK	Cat. No.
8 PCR tube strips plus detached cap strips, domed caps	250	9.407 503 4
8 PCR tube strips plus detached cap strips, flat caps	250	9.407 514 5
8 PCR detached cap strips, flat caps	120	6.254 729
8 PCR detached cap strips, domed caps	250	7.656 858



LLG-96-well PCR Plates, PP

- cut-away corner for orientation
- clear well bottom for sample visibility, with V-Bottom
- compatible with leading thermocyclers
- consistent wall thickness for uniform heat transfer
- holes in the skirt for easy handling
- virgin polypropylene, certified RNase, DNase and endotoxin free

Description	Capacity µl	PK	Cat. No.
96 Well Plate, skirted, low profile, PP	200	25	9.407 507
96 Well Plate, non-skirted, PP	300	25	6.238 061



LLG-PCR adhesive film and foil

For use in cyclers with screw-down or clip-down lids. With end tabs

PCR Film: Clear film allows both the visual inspection of samples and fluorescence measurements.
 PCR Foil: Aluminium, easy to pierce, no residue of adhesive on the pipette tips.
 QPCR Foil: Adhesive seal optically clear, peelable, for QPCR and fluorescence applications.

Description	Temp. range °C	PK	Cat. No.
PCR film	-20 to +120	100	6.238 132
PCR foil	-80 to +150	100	9.407 506
QPCR foil	-40 to +120	50	6.240 725

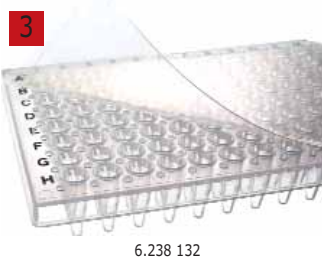

5 96-Well PCR Rack, HDPP

- Manufactured from high density polypropylene which is fully autoclavable.
- Excellent rack for "before" and "after" PCR sampling.
- This rack can be used alone or inserted in the workstation.
- This working/storage rack is designed to accommodate 96 pieces 0.2 ml PCR tubes or strips of 8 and 12 tubes.
- Tube wells are easily identified with alphanumeric, embossed numbers and letters.
- Translucent clear cover protects the tubes from dust and has a non-slip surface to allow safe storage of multiple racks.
- Dimensions (W x D x H): 125 x 88 x 31 mm

For tubes ml	PK	Cat. No.
0.2	1	6.255 804



6 96-Well PCR Rack, PP

Removable hinged lid lies flat. Perfect for pre- or post-PCR sampling. Sturdy polypropylene rack accommodates individual 0.2 ml tubes or strips of 8 or 12 tubes. Tube wells are easily identified with embossed numbers and letters. Dimensions (L x W x H): 130 x 98 x 33 mm. Autoclavable.

For tubes ml	Colour	PK	Cat. No.
0.2	blue, green, pink, yellow, orange	5	9.409 661
0.2	green	1	6.256 114





1 Cell culture flasks, treated, PS, sterile

These cell culture flasks with treated surfaces for the cultivation of adherent cells are available with different growth areas from 12.5 to 182 cm². Available with vented or plug-seal caps made from polyethylene. Vented caps contain a 0.22 µm hydrophobic filter to allow gas exchange and minimize risk of cross-contamination. Plug Seal caps can be used in closed systems, providing a liquid and gas sheer seal, but by simply unscrewing the cap one quarter of a turn, this cap can also be used in an open system.

- Features:
- Innovative angled neck design offers good pipette and cell scraper access
 - Upper triangular and wider base shape provides stability
 - Stackable
 - Special writing area near the neck
 - Engraved graduation on both flask sides
 - Sterilized by gamma irradiation
 - Non-pyrogenic
- Material: Polystyrene

Working volume ml	Neck thread mm	Culture surface cm ²	Neck	Cover type	PK	Cat. No.
20	45	12.5	angled	standard	10	6.267 172
20	45	12.5	angled	vented	10	6.267 173
40	45	25.0	angled	standard	10	6.267 174
40	45	25.0	angled	vented	10	6.267 175
75	45	75.0	angled	standard	5	6.267 176
75	45	75.0	angled	vented	5	6.267 177
400	45	182.0	angled	standard	5	6.267 178
400	45	182.0	angled	vented	5	6.267 179



2 Cell Culture Plates, treated, PS, sterile

These standard surface treated cell culture plates for the cultivation of adherent cells exhibit a reduced evaporation due to raised well rims and uniform rings on the lids.

- Available with 6-, 12-, 24-, 48- or 96-wells (lid included)
 - Flat well bottom
 - 96-well plate also available as round bottom plate (6.267 171)
 - Single position lid reduces the risks of cross-contaminations
 - Wells are labeled with alphanumeric code for easy identification
 - Sterilized by gamma irradiation
 - Non-pyrogenic
- Material: Polystyrene

Working volume ml	Culture surface cm ²	No. of wells	PK	Cat. No.
17.00	10.00	6	100	6.267 166
6.80	4.20	12	100	6.267 167
3.50	2.00	24	100	6.267 168
1.55	0.85	48	100	6.267 169
0.39	0.38	96	100	6.267 170
0.32	0.38	96	100	6.267 171



1 Aspirator LLG-uniVACUUSYS

LLG-uniVACUUSYS Vacuum Aspiration System **with integrated vacuum pump and vacuum controller** is ideally suited for aspirating liquids in Life Science applications, e.g. the removal of media from cell cultures, aspiration of supernatants after centrifugation, or the removal of wash solutions from Immuno assay plates. The set vacuum is automatically re-adjusted in case of deviations.

- Integrated vacuum pump with vacuum control
- Easy to use
- Self-closing connectors for quick installation and prevention of liquid or aerosol escape
- **Liquid level sensor**, prevents liquid overflow
- Autoclavable waste collection bottle and nozzle

Scope of delivery: Vacuum Aspiration System with integrated vacuum pump, 4 liter waste collection bottle, single channel needle and 8-channel needle aspirator handle, tubing and quick-connectors

Specifications

Vacuum range:	0 to 600 mbar (adjustable)
Aspiration rate:	1 to 15 ml/s
Noise emission:	<50 dB(A)
Dimensions (W x D x H):	180 x 320 x 530 mm
Weight:	3.4 kg
Power supply:	100 - 240 V, 50/60 Hz
Warranty:	3 years



Type	PK	Cat. No.
LLG-uniVACUUSYS with EU-plug	1	6.263 585
LLG-uniVACUUSYS with UK-plug	1	6.263 586
8-channel needle	1	6.263 588
Bottle cap	1	6.263 584
Handle, incl. single pin	1	6.263 583

2 Filter units, PES membrane

These bottle-top filter units are ideally suited for the separation or purification of samples which are contained in large volumes. The units are available with either 0.22 µm or 0.45 µm pore sizes and 3 different volumes (250, 500 and 1000 ml).

Features:

- Bottle-top filter and reservoir bottle are included
- Light weight and stable wall construction
- Large knurls on the reservoir bottle cap for easy screwing
- Wide bottle mouth for efficient pouring out
- Volume graduation
- Hose connector fits multiple diameters
- Non-pyrogenic

Membrane material: Polyethersulfone (PES)

Capacity	Pore size	Neck thread	PK	Cat. No.
ml	µm	mm		
250	0.22	45	12	6.267 180
250	0.45	45	12	6.267 181
500	0.22	45	12	6.267 182
500	0.45	45	12	6.267 183
1000	0.22	45	12	6.267 184
1000	0.45	45	12	6.267 185



1



1 LLG-Petri dishes, Soda-lime glass

Ext. diam. mm	Height mm	PK	Cat. No.
40	12	1	9.170 570
60	15	1	9.170 571
80	15	1	9.170 572
90	15	1	9.170 575
100	10	1	9.170 573
100	15	1	9.170 574
100	20	1	9.170 576
120	20	1	9.170 577
150	25	1	9.170 578
180	30	1	9.170 579
200	30	1	9.170 580
200	50	1	9.170 581

2

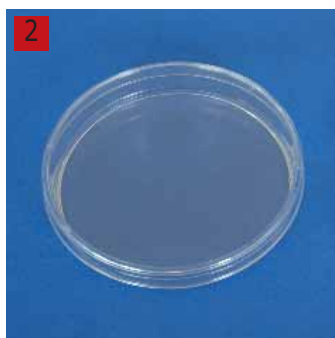

2 LLG-Petridishes, PS

- Made of high quality optical clear polystyrene. Produced under aseptic conditions in an ISO 6 cleanroom.
- With a smooth surface for an optimal distribution of the transport medium
 - Stable thickness to prevent any deformations while using
 - Stackable
 - With or without vents
 - Aseptic (90 mm diam.) or beta irradiated sterile versions (all sizes)
 - Contact plate with counting grid
 - Packed in sleeves with 10 dishes or 20 dishes (90 mm diam. dishes)

Ext. diam. mm	Description	Height approx. mm	PK	Cat. No.
90	with triple vents, aseptic	16	480	6.285 823
90	without vents, aseptic	16	480	6.285 824
90	with triple vents, sterile	16	480	6.285 816
90	without vents, sterile	16	480	6.285 817
60	with triple vents, sterile	14	1000	6.285 818
60	without vents, sterile	14	1000	6.285 819
55	contact plate, sterile	17	1000	6.285 821
150	with triple vents, sterile	19	180	6.285 822

3



9.908 127

Petri dish holder

Constructed in steel wire, as outlined below. Suitable for dish diameters of 100 mm, Internal diameter approx. 102 mm, Internal height approx. 230 mm. For approx. 10 petri dishes.

Description	PK	Cat. No.
Electropolished, grade 1.4301 stainless steel	1	9.908 127 3
White nylon-coated	1	9.908 128

1 LLG-Drigalski spatulas and Inoculation hooks

For easy plating.



Description	Diam. mm	Width mm	Length mm	Material	PK	Cat. No.
LLG-Drigalski spatulas	4	40.0	190	Stainless steel 18/10	1	9.197 490
LLG-Drigalski spatulas	3	24.5	150	Wironit, CrNi 18/12, straight	1	9.197 496
LLG-Drigalski spatulas	3	45.0	190	Wironit, CrNi 18/12, angular 10°	1	9.197 497
LLG-Drigalski spatulas	5	30.0	150	Borosilicate glass 3.3	1	9.197 499
LLG-Drigalski spatulas	4	51.5	174	PS, sterile	100	6.251 768
LLG-Inoculation hook	5	40.5	145	Glass	1	9.520 206
LLG-Inoculation hook	4	57.0	185	Stainless steel	1	9.520 205

LLG-Dry swabs, sterile

Description	Ext. diam. mm	Length mm	PK	Cat. No.
with Cotton tip, in PP test tube	12	150	1000	6.272 800
with Rayon tip and plastic stick, in PP test tube	12	150	1000	6.272 801
with Cotton tip and wooden stick, individually wrapped		150	1000	9.404 004
with Rayon tip and plastic stick, in PP test tube, individually wrapped	12	150	150	9.404 005 2
with Rayon tip and plastic stick, individually wrapped		150	1000	9.404 006 3
with clear Amies medium, Rayon tip and plastic stick, in PP test tube	12	150	150	9.404 007
with clear Amies medium with Charcoal, Rayon tip and plastic stick, in PP test tube	12	150	150	9.404 008

2



9.404 005

3



9.404 006

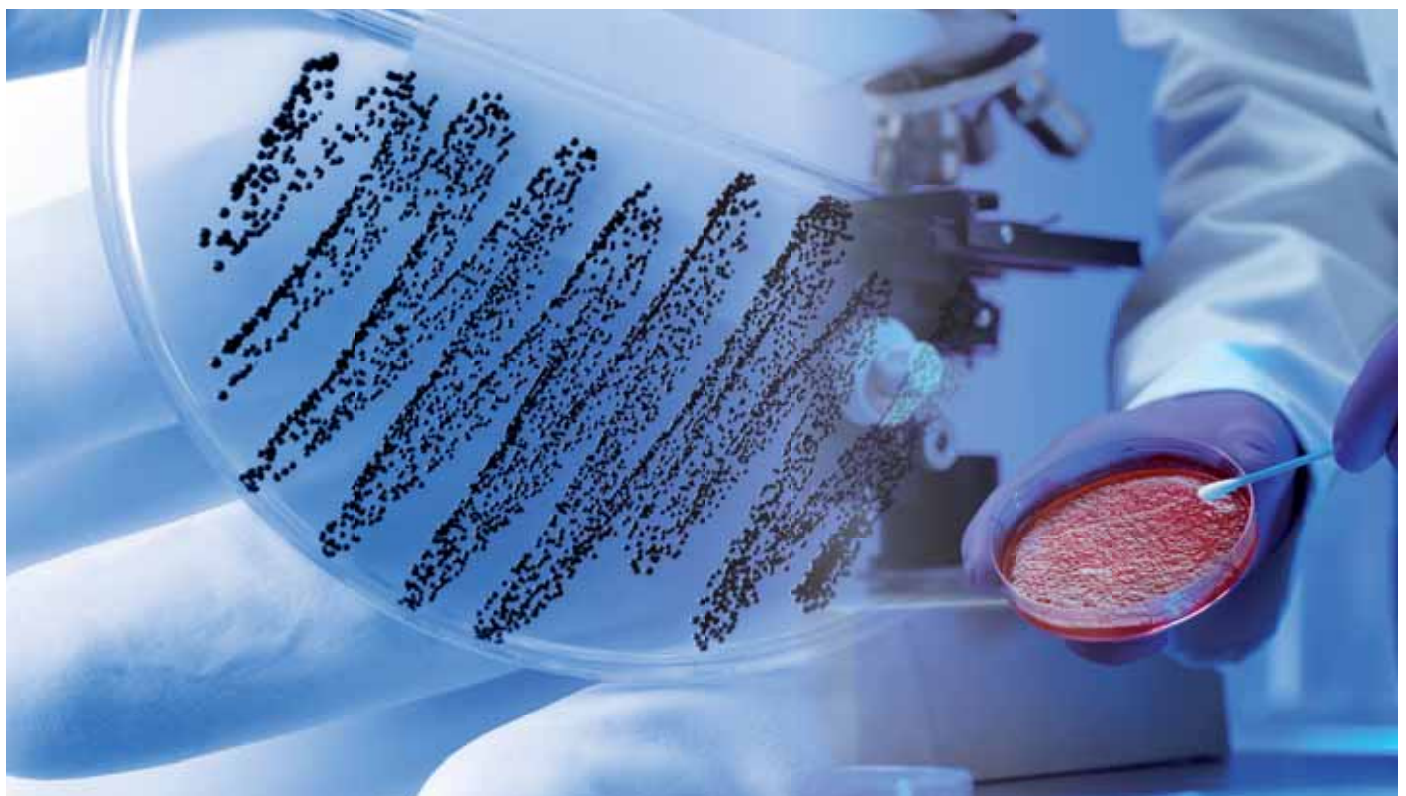



1 Cotton Applicator

Ideal for sampling in laboratories

9.413 160: non-sterile, according to EN ISO 13485
9.413 161: sterile, according to EN ISO 13485 and conforming to 93/42/EEC, enclosure V for medical products, sterilised with ETO gas

Length mm	Wall thickness mm	Head size mm	Sterile	Material	Package	PK	Cat. No.
150	2.2	Ø 4 to 5.5 mm	no	Wood	bag	100	9.413 160
150	2.2	Ø 4 to 5.5 mm	yes	Wood	single, Peel-Pack	100	9.413 161



2 LLG-Inoculation loops, PS, sterile

Made of flexible polystyrene. With ultra-smooth loops for problem-free planting and streaking of cultures. Free of lubricants, oils and electrostatic charges, enabling consistent and complete liquid transfer. Ergonomic design of the loops for optimal grip and an easy orientation of the loop head. Needle end shape is perfect for picking off individual isolated colonies and suitable for making stab inoculations into agar slants or tubes of solid culture medium. Package: 10 bags of 10 pieces

Type	Capacity µl	PK	Cat. No.
Needle / loop	1	100	9.160 041
Needle / loop	10	100	9.160 042
Loop / loop	1 / 10	100	9.160 043

LLG-spatulas, sterile

Ideal for the uniform spreading of cell cultures and liquids
- Smooth, rounded surfaces for uniform spreading without scratching the agar surface
- Ethylene oxide sterilized
- Sterile, 10 per bag or individually packed
- Autoclavable

Description	Width mm	Length mm	Material	Package contents	PK	Cat. No.
LLG - Spatula, L-shaped, blue, sterile	38.0	156	ABS	50 x 10	500	6.265 638 ²
LLG - Spatula, L-shaped, blue, sterile	38.0	156	ABS	individually packed	500	6.265 639
LLG - Spatula, T-shaped, blue, sterile	34.0	140	ABS	50 x 10	500	6.265 640 ⁴
LLG - Spatula, T-shaped, blue, sterile	34.0	140	ABS	individually packed	500	6.265 641
LLG - Spatula, Delta-shaped, blue, sterile	30.0	208	PP	100 x 10	1000	6.265 642 ⁵



6.265 638



6.265 640



6.265 642



6 7 LLG-Inoculation loops, sterile

Uniform surface wetting and complete transfer of the liquid. The inoculation loops are available as more rigid versions (PS) or flexible versions (HIPS). Smooth edges ensure gentle agar treatment.
- EO sterilized
- Color coded
- Hexagonal handle for easy handling

Capacity µl	Length mm	Material	Colour	PK	Cat. No.
1	173	PS	transparent	1000	6.290 917
10	173	PS	green	1000	6.290 918
1	173	HIPS	yellow	1000	6.290 919
10	173	HIPS	white	1000	6.290 920

1 Culture flasks, borosilicate glass 3.3

Erlenmeyer. With 3 side baffles. Neck straight or with beaded rim.

Capacity ml	Diam. mm	Neck diam. mm	Height mm	Beaded rim	PK	Cat. No.
100	64	38	112	without	1	9.010 120
250	85	38	145	without	1	9.010 121
500	105	38	183	without	1	9.010 122
1000	131	38	232	without	1	9.010 123
2000	166	38	305	without	1	6.236 466



2 LLG-Cellulose stoppers, Steristoppers®

Cellulose, 100 % biodegradable and fully compostable autoclavable. Steristoppers® have been proved as an excellent sealing for microbiological samples and tissue cultures in test tubes and Erlenmeyer flasks. They are in constant use in many European microbiological laboratories.

- Autoclavable
- Filters bacteria
- Sterilisable
- Air permeable



Type	For inter. diam. mm	Bottom diam. mm	Top diam. mm	Length mm	PK	Cat. No.
No. 9	10,5 - 11,5	10.0	12.0	28	2000	9.231 209
No. 10	9,5 - 11,5	9.0	14.0	31	1000	9.231 210
No. 11	12,0 - 14,5	13.0	16.0	39	1000	6.800 324
No. 12	11,5 - 13,5	11.0	16.0	32	1000	9.231 211
No. 13	12,5 - 14,5	13.0	17.0	35	1000	9.231 212
No. 14	13,0 - 14,5	12.0	16.0	40	1000	9.231 214
No. 14,5	14,0 - 16,0	13.0	17.0	35	1000	9.231 216
No. 15	13,5 - 15,5	14.0	18.0	39	500	9.231 215
No. 18	17,5 - 18,5	17.0	21.0	38	500	9.231 218
No. 19	19,0 - 22,0	17.0	25.0	42	500	9.231 221
No. 22 short	21,5 - 23,0	20.0	25.0	31	500	6.239 556
No. 23.5 P	25,0 - 27,0	25.0	30.0	40	500	9.231 225
No. 26	26,0 - 27,0	23.0	28.0	42	500	9.231 226
No. 27	27,0 - 32,5	25.0	35.0	53	1000	7.210 063
No. 29	29,5 - 31,0	30.0	34.0	62	250	9.231 229
No. 32	32,5 - 35,0	32.0	36.0	64	100	9.231 232
No. 32 P	32,0 - 33,0	30.0	49.0	54	150	9.231 233
No. 34	33,5 - 36,5	33.0	38.0	63	150	9.231 234
No. 36	35,5 - 39,5	36.0	40.0	58	600	7.600 688
No. 37	37,5 - 41,5	39.0	46.0	59	100	9.231 237
No. 38	40,0 - 43,5	38.0	48.0	60	100	9.231 238
No. 40 P	42,0 - 46,5	40.0	50.0	53	100	9.231 240
No. 45 P	47,0 - 48,0	45.0	60.0	66	75	9.231 245
Magnum (for glasses with variable wall thickness)	26,0 - 30,0	26.0	34.0	69	800	6.073 109

P = correct fit, D = thin, W = soft, S = pointed, H = tougher version

LLG-Micropestles, stainless steel

Polished stainless steel, micropestles. Precisely fitted for Eppendorf Safe-Lock Tubes™, manufactured in one-piece, smooth handle sections, can be disinfected easily. Minimum homogenate displacement due to tapered piston.

For Reaction tubes:

For homogenisation of cells, tissues or foodstuffs/feed samples.

- For tubes with 0.5 ml, 1.5 ml and 2.0 ml
- Can be cooled down to -196 °C
- Sterilisable in an autoclave or dry heat at +200 °C
- Suitable for PCR applications
- Alternative to single-use plastic pestles
- Perfectly suitable for Eppendorf Safe-Lock Tubes

For Sarstedt tubes:

Primarily used with food analysis with highly processed samples in which little DNA, protein or allergen is present.

- For tubes 13ml (Cat. No. 6.239 124)

For volume ml	Pestle length mm	PK	Cat. No.
0.5	94	1	9.314 500 1
1.5	124	1	9.314 501 2
2.0	120	1	9.314 502 3
13.0	190	1	9.314 503 4



9.314 500



9.314 501



9.314 502



9.314 503



9.730 115

Shakers, Disruptor Genie® analog/digital

For cell disruption and homogenisation. The patented Disruptor Genie® provides a multi-directional action, which simultaneously agitates and vortexes at high speed, dramatically increasing cell disruption or sample resuspension efficiency.

- For accurate, repeatable and reproducible results
- Dramatically increased sample disruption efficiency. Ideal for difficult glass bead procedures (Glass beads - please order separately), cell disruption/homogenisation of yeast, bacteria, plant and animal tissues and pellet resuspensions or anything that requires extremely violent, high-speed agitation.
- Patented multi-directional action simultaneously agitates and vortexes at high-speed producing greater yields in less time
- Hands-Free disruption of up to twelve 1.5ml or 2.0ml microtubes with timer from 0 to 15 minutes (Disruptor Genie® analog), 0 to 99 minutes (Disruptor Genie® digital) or continuous operation
- Performance comparable to expensive ultrasonic cell disruptors/homogenisers.
- Suitable for use in cold rooms or incubators
- Remove the microtube holder and attach the supplied pop-off cup for high-speed vortexing of single test tubes

Supplied with: Disruptor Genie, tube holder for 12 tubes, pop-off cup



6.253 276

Specifications

Speed	
Disruptor Genie® analog:	2850 rpm
Disruptor Genie® digital:	1000 to 2850 rpm
Dimensions (W x D x H):	122 x 165 x 190 mm
Weight:	4.3 kg
Supply requirements:	220V 50 Hz, 250 mA

Type	Connector	PK	Cat. No.
Disruptor Genie® analog	EU	1	9.730 115 5
Disruptor Genie® digital	EU	1	6.253 276 6

1 Scalpels, disposable Cutfix®

Sterile. For cleaner, smoother, more accurate incisions.

- Excellent cutting ability of stainless steel blade
- Ergonomic solid plastic handle
- Ready for use, sterile packed
- Complete range of blades for every incision
- Individually packed precision knife with cap
- Total length about 150 mm depending on the blade shape and length

Type	PK	Cat. No.
10	10	9.409 804
11	10	9.409 805
12	10	9.409 806
15	10	9.409 807
20	10	9.409 808
21	10	9.409 809
22	10	9.409 810
23	10	9.409 813
24	10	9.409 814



2 Reaction tubes CapLock®, PP

The new CapLock® cap closure guarantees optimum tube sealing for all applications.

CapLock® tubes provide enhanced sample security and stay safely closed, even in boiling water baths.

- Pyrogen-/RNase-/DNase-free, non-sterile and cleanroom-manufactured ISO Class 8
- moulded in transparent, medical grade, PP
- can be centrifuged up to 30000 x g
- autoclavable: at 1 bar, 121 °C for 15 min
- with labelling area on cap and tube
- high chemical resistance
- graduation for an easy volume identification

Certificate of Conformity according to DIN EN 10204 2.1

Capacity ml	PK	Cat. No.
1.5	1000	9.407 700



LLG-Centrifuge tubes, 5ml, PP, non-sterile

The LLG-Centrifuge tubes 5ml, non-sterile, represent the perfect solution for all laboratory applications requiring incubation, centrifugation and sample handling in an intermediate volume range. The LLG centrifuge tubes are available in clear, amber for use with light sensitive samples and as a color assorted pack (green, blue, yellow and red).

- Max. 25.000 x g, suitable for high speed centrifugation
- Graduations every 0.25 ml for easy volume estimation
- A flat, frosted cap and large writing pad for sample labeling and identification
- Autoclavable
- Fits all rotors and racks that hold 15 ml conical tubes, no adapters needed
- Certified free of RNase and DNase

Description	Package contents	PK	Cat. No.
Clear	1 bag of 250 pieces	250	6.281 113
Colour assortment green, yellow, red, blue	4 bags of 50 pieces (1 colour per bag)	200	6.281 114
Amber	1 bag of 250 pieces	250	6.281 115



6.281 113



6.281 114



6.281 115

LLG Deep well plates, PP

- produced in a cleanroom environment
- RNase-, DNase-, Human DNA- and Pyrogen-free
- virgin Polypropylene
- choice of well-types

LLG Deep well plates, 96 well, PP

- Cut-away corner for orientation
- Resistant to DMSO and low temperatures (-196 °C)
- Autoclavable (121 °C)
- Virgin polypropylene, certified RNase, DNase and endotoxin free

Description	Capacity µl	Colour	PK	Cat. No.
96 Well Storage Plate, round caps, with V-Bottom	800	transparent	50	9.407 508 1
96 Deep Well Storage Plate, round caps, with U-Bottom	1200	transparent	50	9.407 509 2
96 Deep Well Storage Plate, square caps, with V-Bottom	2200	transparent	50	6.263 838
96 Deep Well Storage Plate, square caps, with U-Bottom	1200	transparent	50	7.608 837

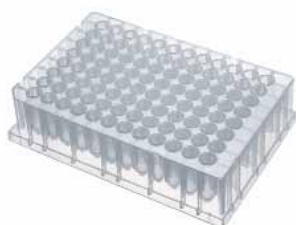
1

9.407 508

2

9.407 509

3

3 LLG-Deep well plates, 384-well, PP

- 384 square wells
- pyramidal well bottom for optimal sample retrieval
- raised rims for optimal sealing and reduced risk of cross-contamination
- raised rims on the corners to protect edges of seals
- chemical resistant (e.g. against DMSO, Phenol, Chloroform)
- autoclavable (121 °C)
- Virgin polypropylene, certified RNase, DNase and endotoxin free

Description	Capacity µl	PK	Cat. No.
384 Well Storage Plate, with V Bottom	120	50	9.407 510
384 Well Storage Plate, with V Bottom	300	50	9.407 512





4

4 LLG-Sealing mats for Deep well plates, 96-well

- for sample storage
- not DMSO resistant
- alphanumeric grid
- thermoplastic elastomer
- flexible with end tabs
- with round or angled nodules

For	Description	PK	Cat. No.
9.407 508 / 9.407 509	with round nodules, piercable, autoclavable	50	9.407 513





LLG-Crimp Neck Micro-Vials ND8

				
Capacity	0.20	0.30	0.60	1.20
o.d. x Height	5.5 x 31.5	5.5 x 31.5	7 x 40	8.2 x 40
Colour	clear	clear	clear	clear
Form	conical	round bottom	conical	flat bottom
PK	100	100	100	100
Cat. No.	6.235 606	4.001 554	4.001 515	4.008 206



LLG-Aluminium Crimp Caps ND8, ready assembled

	Caps	Septa	Hardness	Thickness mm	PK	Cat. No.
	Aluminium, silver, center hole	Silicone white / PTFE red	45° shore A	1.30	100	9.003 444









LLG-Screw Neck Vials ND8, small opening

				
Capacity	1.50	1.50	1.50	1.10
o.d. x Height	11.6 x 32	11.6 x 32	11.6 x 32	11.6 x 32
Colour	clear	clear	amber	clear
Form	flat bottom	flat bottom	flat bottom	conical
PK	100	1000	100	100
Cat. No.	9.003 481	6.401 175	9.003 480	4.001 563



LLG-Micro-Inserts for Screw Vials ND8, small opening

			
Capacity	0.10	0.10	0.20
o.d. x Height	5 x 31	5 x 29	5 x 31
Colour	clear	clear	clear
Form	conical, 9mm tip	with plastic spring	flat bottom
PK	100	100	100
Cat. No.	9.003 435	4.001 556	4.008 194

LLG-PP Screw Seals ND8, ready assembled, and empty Screw Caps ND8

Caps	Septa	Hardness	Thickness mm	PK	Cat. No.
 	black, centre hole	Natural rubber red-orange / TEF transparent	60° shore A	1.30	100 6.266 866
	black, closed	Natural rubber red-orange / TEF transparent	60° shore A	1.30	100 6.266 867
	black, centre hole	Red Rubber / PTFE beige	45° shore A	1.00	100 4.008 209
	black, closed	Red Rubber / PTFE beige	45° shore A	1.00	100 4.008 210
	black, centre hole	Silicone white / PTFE red	45° shore A	1.30	100 9.003 484
	black, centre hole	Silicone white / PTFE red, slit	45° shore A	1.30	100 6.232 178
	black, centre hole	no liner	-	-	100 7.060 421
	black, closed	no liner	-	-	100 7.075 960

LLG Septa for Screw Caps ND8

Septa	Hardness	Thickness mm	PK	Cat. No.
	PTFE virginal, white	53° shore D	0.25	100 7.085 238
	Silicone white / PTFE red	45° shore A	1.30	100 7.060 419

1

1 LLG - 2in1KIT with Screw Neck Vials ND8 (small opening)





2in1KIT contains 100 vials and 100 closures in an PP-Box. As all components are always required at the same time, this kit is a convenient way to obtain and store all required items for analysis. Kits are available for any type of 1.5 ml (32 x 11.6 mm), 4 ml (45 x 14.75 mm) or 20 ml Headspace Vial (75.5 x 23 mm) with an appropriate seal. All advantages of the individual components (cleanroom packaging of the vials, recloseability of the packaging, etc.) remain unchanged.

Any other combination of vial and seal are available.





Type	Description	Capacity ml	Cover type	PK	Cat. No.
2in1 Kit	clear	1.50	Screw Cap, black, hole, Silicon white / PTFE red	100	6.238 965

 Storage Boxes - please see page 192.



LLG-Short Thread Vials ND9, wide opening

					
Capacity	0.20	1.50	1.50	1.50	1.50
o.d. x Height	6 x 31	11.6 x 32	11.6 x 32	11.6 x 32	11.6 x 32
Colour	clear	clear	clear, labelling field	amber	amber, labelling field
Form	flat bottom	flat bottom	flat bottom	flat bottom	flat bottom
PK	100	100	100	100	100
Cat. No.	4.008 196	9.003 448	4.662 800	4.008 247	4.662 801

LLG-Short Thread Vials ND9, wide opening, Micro-Vials

				
Capacity	1.10	0.20	0.20	0.30
o.d. x Height	11.6 x 32	11.6 x 32	11.6 x 32	11.6 x 32
Colour	clear	clear	amber	transparent
Form	flat bottom, 15µl funnel in solid glas bottom	flat bottom with integrated 0.2mL insert	flat bottom with integrated 0.2mL insert	PP, with inner cone
PK	100	100	100	100
Cat. No.	4.008 249	4.008 250	4.008 252	4.008 262



Inserts for LLG-Short Thread Vials ND9, wide opening

			
Capacity	0.10	0.10	0.10
o.d. x Height	6 x 31	6 x 31	5.7 x 29
Colour	clear	clear	clear
Form	conical 15mm tip	conical 12mm tip	with plastic spring
PK	100	100	100
Cat. No.	7.401 744	4.001 547	6.093 247















LLG-Short Thread Vials ND9, wide opening, SureStop™

The short thread vials ND9 SureStop™ are the best available on the market in terms of seal tightness and reliability. The vials have an additional stopper ring at the end of the thread which clearly marks the end point in the screwing-in process. This ensures that the tightness of the seal is independent of the touch or feel of the user screwing the stopper in. This ensures the lowest possible number of standard deviations and high reproducibility of analysis results.



- Stopper ring as protection against over-tightening
- 1st hydrolytic class glass
- In clear and amber glass
- Wide opening requires matching micro-inserts

			
Capacity	1.50	1.50	1.50
o.d. x Height	11.6 x 32	11.6 x 32	11.6 x 32
Colour	clear	clear, labeling field	amber, labeling field
Form	flat bottom	flat bottom	flat bottom
PK	100	100	100
Cat. No.	6.266 869	6.260 742	6.260 743

LLG-PP Short Thread Seals ND9, ready assembled

	Caps	Septa	Hardness	Thickness mm	PK	Cat. No.
	transparent, centre hole	Natural rubber, red-orange / TEF transparent	60° shore A	1.00	100	6.266 872
	blue, centre hole	Natural rubber, red-orange / TEF transparent	60° shore A	1.00	100	6.266 883
	blue, centre hole	Red Rubber / PTFE beige	45° shore A	1.00	100	4.008 228
	blue closed	Red Rubber / PTFE beige	45° shore A	1.00	100	4.008 230
	transparent, centre hole	Silicone white / PTFE red	55° shore A	1.00	100	7.076 778
	black, centre hole	Silicone white / PTFE red	55° shore A	1.00	100	4.008 225
	blue closed	Silicone white / PTFE red	55° shore A	1.00	100	4.008 227
	transparent, centre hole	Silicone white / PTFE blue, slit	55° shore A	1.00	100	7.200 809
	blue, centre hole	Silicone white / PTFE blue, slit	55° shore A	1.00	100	4.001 521
	black, center hole	Silicone white / PTFE blue, slit	55° shore A	1.00	100	4.008 226
	blue, centre hole	PTFE red / Silicone white / PTFE red	45° shore A	1.00	100	4.008 218
	blue, centre hole	PTFE virginal, white	53° shore D	0.25	100	4.008 221
	blue closed	PTFE virginal, white	53° shore D	0.25	100	7.930 366
	blue, centre hole	PTFE red / Silicone white	45° shore A	1.00	100	6.291 638

LLG-PP UltraBond*Short Thread Seals ND9

	Caps	Septa	Hardness	Thickness mm	PK	Cat. No.
	Ultrabond* Seal blue, center hole	Silicone beige / PTFE white	45° shore A	1.30	100	4.008 214
	Ultrabond* Seal blue, center hole	Silicone beige / PTFE white, slit	45° shore A	1.30	100	4.008 215

*Cap+Liner form an inseparable unit, so that the liner cannot be pushed into the vial even with a blunt needle

LLG-Septa for Thread Screw Caps ND9

Septa	Hardness	Thickness mm	PK	Cat. No.
 Silicone white / PTFE red	55° shore A	1.00	100	4.008 212

1 LLG-2in1 KITS with Short Thread Vials ND9 (wide opening)

2in1 KITS contain 100 vials (1.5 ml) and 100 closures in a PP-Box. As both components are always required at the same time, 2in1 KITS are a convenient way to obtain and store all required items for analysis. All advantages of the individual components (cleanroom packaging of the vials, recloseability of the packaging, etc.) remain unchanged.



Any other combination of vial and seal as a 2in1 KIT available.

1







Description	Cover type	PK	Cat. No.
clear	Short Thread Cap, blue, hole, Silicon white / PTFE red	100	9.003 560
clear	Short Thread Cap, transparent, hole, Silicon white / PTFE red	100	9.003 561
clear, labelling field	Short Thread Cap, blue, hole, Silicon white / PFE blue, slitted	100	9.003 562
clear, labelling field	UltraClean Short Thread Cap, blue, hole, Silicon white / PFE red	100	7.970 892
amber, labelling field	UltraBond Short Thread Cap, blue, hole, Silicon beige / PTFE white, slitted	100	9.003 563
amber, labelling field	UltraClean Short Thread Cap, blue, hole, Silicon white / PFE red	100	6.266 871

LLG-Screw Neck Vials ND10, wide opening and Micro-Inserts

Capacity o.d. x Height	ml mm			
1.50	11.6 x 32	clear	clear, labeling field	amber, labeling field
Form		flat bottom	flat bottom	flat bottom
PK		100	1000	100
Cat. No.		6.242 103	7.615 715	6.280 951

LLG-PP Screw Seals ND10, ready assembled



	Caps	Septa	Hardness	Thickness mm	PK	Cat. No.
	black, closed	Natural Rubber red-orange / TEF transparent	60° shore A	1.30	100	6.267 112
	black, center hole	Red rubber / PTFE beige	45° shore A	1.00	100	6.242 104
	black, center hole	Silicone white / PTFE red	45° shore A	1.30	100	4.008 235
	black, center hole	Silicone white / PTFE blue, slit	55° shore A	1.50	100	4.008 237
	black, center hole	PTFE red / Silicone white / PTFE red	45° shore A	1.00	100	4.008 236

LLG Crimp Neck Vials ND11, small and wide opening (flat bottom)

Capacity o.d. x Height Colour Form	ml mm					
		1.50 11.6 x 32 clear small opening	1.50 11.6 x 32 clear wide opening	1.50 11.6 x 32 amber wide opening	1.50 11.6 x 32 amber, labeling field wide opening	1.50 11.6 x 32 clear, labeling field wide opening
PK		100	100	100	100	100
Cat. No.		7.085 511	6.291 635	6.263 047	6.291 636	6.290 019



LLG Crimp Neck Vials economy ND11, wide opening

Hydrolytical class 1, expansion 70.





Capacity o.d. x Height Colour Form	ml mm		
		1.50 11.6 x 32 clear flat bottom	1.50 11.6 x 32 amber flat bottom
PK		1000	1000
Cat. No.		6.273 632	6.273 633

LLG-Short Thread Vials economy ND9, wide opening

Hydrolytical class 1, expansion 70.

Capacity o.d. x Height Colour Form	ml mm		
		1.50 11.6 x 32 clear flat bottom	1.50 11.6 x 32 amber flat bottom
PK		1000	1000
Cat. No.		6.273 634	6.273 635

LLG-Aluminium Crimp Seals ND11, ready assembled

	Caps	Septa	Hardness	Thickness mm	PK	Cat. No.
	aluminium, silver, centre hole	Natural rubber red-orange / TEF transparent	60° shore A	1.30	100	9.003 441
	aluminium, silver, centre hole	Natural rubber / Butyl red-orange / TEF transparent	45° shore A	1.00	100	7.060 469
	aluminium, silver, centre hole	Silicone white / PTFE red	45° shore A	1.30	100	9.003 446
	aluminium, silver, centre hole	Silicone white / PTFE blue, cross-slit	55° shore A	1.50	100	4.001 555
	aluminium, silver, centre hole	Red Rubber / PTFE beige	45° shore A	1.00	100	6.291 637

1 LLG-2in1 KITS with Crimp Neck Vials ND11 (wide opening)

2in1 KITS contain 100 vials and 100 closures in a PP-Box. As both components are always required at the same time, 2in1 KITS are a convenient way to obtain and store all required items for analysis. 2in1 KITS are available for any type of 1.5 ml (32 x 11.6 mm), 4 ml (45 x 14.75 mm) or 20 ml Headspace Vial (75.5 x 23 mm) with an appropriate seal. All advantages of the individual components (cleanroom packaging of the vials, recloseability of the packaging, etc.) remain unchanged.

Any other combination of vial and seal as a 2in1 KIT available.





Description	Cover type	PK	Cat. No.
clear	Crimp Cap, silver, hole, Natural Rubber red-orange / TEF transparent	100	6.257 139

1









LLG-Snap Ring Vials ND11, wide opening and Micro-Inserts

As an alternative to snap ring seals, snap ring vials and micro-vials ND11 can also be sealed with crimp seals ND11 since the two snap ring lips have the same height as a crimp neck.

Capacity o.d. x Height Colour	ml mm				
Form		1.50 11.6 x 32 clear flat bottom	1.50 11.6 x 32 clear, labeling field flat bottom	1.50 11.6 x 32 amber, labeling field flat bottom	0.30 11.6 x 32 clear, PP flat bottom, integrated 0.3 mL insert
PK		100	100	100	100
Cat. No.		6.073 833	6.270 176	6.270 177	6.267 115





LLG-PE Snap Ring Seals ND11, ready assembled

	Caps	Septa	Hardness	Thickness mm	PK	Cat. No.
	transparent, centre hole	Red Rubber / PTFE beige	45° shore A	1.00	100	4.008 261
	transparent, centre hole	Silicone white / PTFE red	45° shore A	1.30	100	4.001 544
	transparent, centre hole	Silicone white / PTFE blue, cross-slit	55° shore A	1.00	100	4.008 256
	snap ring cap, blue, centre hole	Silicone white / PTFE blue, cross-slit	55° shore A	1.00	100	6.242 212
	transparent, centre hole	PTFE red / Silicone white / PTFE red	45° shore A	1.00	100	6.073 555
	transparent, PE centre hole	Red Rubber / TEF transparent	60° shore A	1.00	100	6.291 662







LLG-Aluminium Crimp Seals ND13, ready assembled

Caps	Septa	Hardness	Thickness mm	PK	Cat. No.
 aluminium tear off cap, silver	Pharma-Fix-Septa (Butyl/PTFE)	50° shore A	2.00	1000	6.283 313



LLG-Screw Neck Vials ND 13

Capacity o.d. x Height Colour	ml mm				
Form		flat bottom	labelling field flat bottom	flat bottom	labelling field flat bottom
PK		100	100	100	1000
Cat. No.		9.003 482	6.267 117	7.058 142	9.003 549



LLG-PP Screw Seals ND13, ready assembled and empty Screw Caps ND13

Caps	Septa	Hardness	Thickness mm	PK	Cat. No.
 black, closed top	Butyl red / PTFE grey	55° shore A	1.30	1000	6.240 135
 black, centre hole	Red Rubber / PTFE beige	45° shore A	1.00	100	6.242 468
 black, closed top	Red Rubber / PTFE beige	45° shore A	1.00	100	4.008 267
 black, centre hole	Silicone cream / PTFE red	55° shore A	1.50	100	7.510 053
 black, closed top	Silicone cream / PTFE red	55° shore A	1.50	100	6.242 267
 black, closed top				100	7.060 437



LLG-Septa for Screw Caps ND13

Septa	Hardness	Thickness mm	PK	Cat. No.
 Silicone creme / PTFE red	55° shore A	1.50	100	4.008 263
 PTFE virginal, white	53° shore D	0.25	100	7.058 143



LLG-Screw Neck Vials for Storage Purposes ND 15, ND 18

Capacity o.d. x Height Colour Form	ml mm			
		8.00 16.6 x 61 clear ND15, flat bottom	12.00 18.5 x 66 clear ND15, flat bottom	16.00 20.6 x 71 clear ND18, flat bottom
PK		100	100	100
Cat. No.		6.280 953	6.280 952	6.280 954

LLG-Screw Seals for Screw Neck Vials ND 15, ND 18

	Caps	Septa	Hardness	Thickness mm	PK	Cat. No.
	ND15 cap, black, closed top	Butyl red / PTFE grey	55° shore A	1.60	1000	7.616 653
	ND18 cap, black, closed top	Butyl red / PTFE grey	55° shore A	1.60	100	6.272 871

LLG-Shell Vials with PE cap (fire-polished neck) ND8, ND12, ND15





Capacity o.d. x Height Colour Form	ml mm			
		1.00 8.2 x 40 clear ND8, flat bottom	2.00 11.6 x 31.5 clear ND12, flat bottom	4.00 14.65 x 44.60 clear ND15, flat bottom
PK		100	100	100
Cat. No.		7.300 174	4.008 248	6.280 950

LLG Plugs, PE



For	PK	Cat. No.
ND8 	100	7.300 175





LLG-Snap Cap Vials ND18 and ND22, without lid

Capacity o.d. x Height Colour Form	ml mm				
		5.00 20 x 40 clear ND18, flat bottom	10.00 22 x 50 clear ND18, flat bottom	15.00 26 x 48 clear ND22, flat bottom	25.00 26 x 65 clear ND22, flat bottom
PK		100	100	100	100
Cat. No.		7.051 404	6.803 717	4.008 282	7.090 616





LLG-Snap Caps, PE, ND18 and ND22

For	PK	Cat. No.
 ND18	100	6.051 403
 ND22	100	7.090 617









LLG-Headspace-Precision Thread Vials ND18

Capacity o.d. x Height Colour Form	ml mm			
		10.00 22.5 x 46 clear rounded bottom	10.00 22.5 x 46 amber rounded bottom	20.00 22.5 x 75.5 clear rounded bottom
PK		100	100	100
Cat. No.		9.003 466	6.290 106	4.008 270







LLG-Magnetic Universal Screw Seals ND18 for Precision Thread Vials ND18

Caps	Septa	Hardness	Thickness mm	PK	Cat. No.
 silver, center hole	Butyl red / PTFE grey	55° shore A	1.60	100	4.008 269
 silver, center hole	Silicone blue transparent/ PTFE white	45° shore A	1.30	100	6.241 111
 silver, center hole	Silicone white / PTFE blue	55° shore A	1.50	100	4.008 268
 silver, without hole	Butyl red / PTFE grey	55° shore A	1.60	100	6.262 513







LLG-Headspace-Vials ND20 (5 ml and 10 ml)

									
Capacity	ml	5.00	5.00	6.00	5.00	10.00	10.00	10.00	10.00
o.d. x Height	mm	20 x 38	20 x 38	22 x 38.20	21,7 x 38.20	20.0 x 54.5	20.0 x 54.5	22.5 x 46	22.5 x 46
Colour		clear	amber	clear	clear	clear	amber	clear	clear
Form		flat bottom flat DIN crimp neck	flat bottom flat DIN crimp neck	rounded bottom bevelled HS crimp neck	flat bottom bevelled HS crimp neck	flat bottom flat DIN crimp neck	flat bottom flat DIN crimp neck	flat bottom flat DIN crimp neck	rounded bottom bevelled HS crimp neck
For		Varian	Varian	PerkinElmer	Metrohm	Varian	Varian	DANI, Agilent	CTC, Varian
PK		100	100	100	100	100	100	100	100
Cat. No.		9.003 425	7.060 457	7.052 186	4.008 285	9.003 426	7.080 947	7.050 285	7.850 009

LLG-Headspace-Vials ND20 (20 ml and 50 ml)

								
Capacity	ml	20.00	20.00	20.00	20.00	20.00	20.00	50.00
o.d. x Height	mm	23.25 x 75.5	23.25 x 75.5	22.5 x 75.5	22.5 x 75.5	23 x 75.5	23 x 75.5	31 x 101
Colour		clear	amber	clear	clear	clear	clear, with label	clear
Form		flat bottom flat DIN crimp neck	flat bottom flat DIN crimp neck	flat bottom flat DIN crimp neck	rounded bottom flat DIN crimp neck	rounded bottom bevelled HS crimp neck	rounded bottom bevelled HS crimp neck	flat bottom flat DIN crimp neck
For				DANI, Agilent	CTC, Varian	PerkinElmer	PerkinElmer	
PK		100	100	100	100	100	100	100
Cat. No.		7.401 840	7.080 450	9.003 452	9.003 453	7.060 463	4.008 281	7.060 459





LLG-Crimp Seals ND20, Aluminium, ready assembled

	Caps	Septa	Hardness	Thickness mm	PK	Cat. No.
	silver, center hole	Butyl red / PTFE grey	50° shore A	3.00	100	9.003 454
	silver, center hole	Butyl grey / PTFE grey	50° shore A	3.00	100	4.001 549
	silver, center hole	Pharma-Fix- Septa Butyl/PTFE	50° shore A	3.00	100	9.003 430
	silver, center hole	Silicone blue / PTFE colourless	45° shore A	3.00	100	9.003 434
	silver, center hole	-	-	-	100	7.060 477
	silver, center hole	Silicone white / PTFE beige	45° shore A	3.20	100	9.003 460



LLG-Crimp Seals ND20 (Center Tear Off Caps), Aluminium, unassembled

	Caps	Septa	Hardness	PK	Cat. No.
	siver	Butyl stopper, grey	37° shore A	100	6.270 720

LLG-Headspace Seals ND20 (Pressure Release Caps), Aluminium, ready assembled

	Caps	Septa	Hardness	Thickness mm	PK	Cat. No.
	silver, centre hole	Butyl grey / PTFE grey	50° shore A	3.00	100	4.001 557
	silver, centre hole	Silicone blue transp. / PTFE transparent	45° shore A	3.00	100	7.050 286
	silver, centre hole	Silicone white / PTFE beige	45° shore A	3.20	100	9.003 456
	silver, centre hole	no liner			100	4.008 271

LLG-Crimp Seals ND20 (Complete Tear Off Caps), Aluminium, unassembled

	Caps	Septa	Hardness	PK	Cat. No.
	silver	Butyl stopper, grey	37° shore A	100	7.060 479
	silver	-	-	100	7.056 751

LLG-Bimetal Crimp Seals ND20, ready assembled, magnetic

	Caps	Septa	Hardness	Thickness mm	PK	Cat. No.
	red/silver, centre hole	Silicone blue transp. / PTFE transparent	45° shore A	3.00	100	6.234 541

LLG-Steel Crimp Seals ND20, ready assembled, magnetic

	Caps	Septa	Hardness	Thickness mm	PK	Cat. No.
	gold, center hole 8 mm	Silicone blue transp./ PTFE transparent	45° shore A	3.00	100	7.850 010







LLG-Septa for Crimp Caps ND20

	Septa	Hardness	Thickness mm	PK	Cat. No.
	Pharma-Fix- Septa Butyl/PTFE	50° shore A	3.00	100	7.071 063







LLG Stoppers ND20

	Description	PK	Cat. No.
	butyl grey	100	7.060 433

LLG-Screw Neck Vials ND24 (EPA Vials)

Capacity o.d. x Height Colour Form	ml mm							
		20.00 27.5 x 57 clear flat bottom	20.00 27.5 x 57 amber flat bottom	30.00 27.5 x 72.5 clear flat bottom	40.00 27.5 x 95 clear flat bottom	40.00 27.5 x 95 amber flat bottom	60.00 27.5 x 140 clear flat bottom	60.00 27.5 x 140 amber flat bottom
PK		100	100	100	100	100	100	100
Cat. No.		4.008 204	4.008 298	6.267 124	4.008 297	4.008 299	6.267 126	6.267 127

LLG-PP Screw Seals ND24 (UltraBond Seals and ready assembled Seals ND24), PP Screw Caps ND24 (empty) and Septa ND22

	Caps	Septa	Hardness	Thickness mm	PK	Cat. No.
	white, closed	Butyl red / PTFE gray (mounted)	55° shore A	2.50	1000	7.615 156
	Ultrabond*, white, center hole	Silicone white / PTFE beige	45° shore A	3.20	100	4.008 293
	Ultrabond*, white, closed top	Silicone white / PTFE beige	45° shore A	3.20	100	4.008 292
	white, center hole	no liner			100	4.008 295
	white, closed top	no liner			100	4.008 296
		Silicone white / PTFE beige	45° shore A	3.20	100	4.008 291

*Cap+Liner form an inseparable unit, so that the liner cannot be pushed into the vial even with a blunt needle





1 LLG-Crimp Neck Vial ND20

100 mL crimp neck vial, 51.6 x 94.5 mm, clear, flat bottom, flat DIN crimp neck

Description	PK	Cat. No.
Vials only	88	6.231 858

LLG-Crimping Tools ND8/ND11/ND13/ND20

Stainless steel crimping Tools ND11, ND13, ND20 for cleanroom use available on request.

Description	Size	PK	Cat. No.
Manual crimper, height adjustable, for 11 mm aluminium crimp caps	ND11	1	9.003 471 2
Manual decapper for 11 mm aluminium crimp caps	ND11	1	9.003 367 3
Manual crimper, height adjustable, for 20 mm aluminium crimp caps	ND20	1	9.003 475
Manual decapper for 20 mm aluminium crimp caps	ND20	1	9.003 369

2

9.003 471

3

9.003 367

LLG-Rack for Vials, PP

For all 1.5 and 4 ml vials. For up to 50 vials, blue, stackable.

For vials ml	Dimensions (W x D x H) mm	PK	Cat. No.
1.5	200 x 105 x 17	1	7.970 861 4
4.0	230 x 117 x 28	1	6.280 873 5

4

7.970 861

5

6.280 873

6

9.405 750

LLG-Storage Boxes, PP

* With alphanumeric coding on the edge and the bottom of each cavity. Suitable for storage in the fridge.

For	Colour	Bottle size ml	Dimensions (l x w x h) mm	Array	PK	Cat. No.
ND8, 9, 10, 11	blue	1,5 / 2,0	130 x 130 x 45*	9 x 9	1	9.405 750 6
ND8, 9, 10, 11	orange	1,5 / 2,0	130 x 130 x 45*	9 x 9	1	9.405 751
ND8, 9, 10, 11	green	1,5 / 2,0	130 x 130 x 45*	9 x 9	1	9.405 754
ND13	red	4,0	130 x 130 x 52*	7 x 7	1	9.405 756
ND20	blue	5 / 10 / 20	130 x 130 x 102	5 x 5	1	4.001 528

1 NMR tubes, 3 and 5mm borosilicate glass 3.3, standard

The NMR tubes have precise tolerances for consistent high accuracy. Most suitable for autosampling NMR systems and high-throughput NMR. Manufactured from 33 expansion, low extractable borosilicate glass conforming to USP Type I and ASTM E438, Type I, Class A requirements

- Borosilicate glass 3.3
 - Economy quality
 - One end closed, rim fire polished
 - Applicable until 600 MHz
- Please order closing caps separately.

Outer diam. mm	Int. diam. mm	Length mm	Wall thickness mm	PK	Cat. No.
2.95 ± 0.03	2.36 ± 0.03	178	0.29	50	6.281 792
2.95 ± 0.03	2.36 ± 0.03	203	0.29	50	6.281 793
4.95 ± 0.05	4.19 ± 0.05	178	0.38	100	9.400 310
4.95 ± 0.05	4.19 ± 0.05	203	0.38	100	9.400 311



2 Closing caps for 5 mm NMR and EPR tubes

For	Colour	PK	Cat. No.
5 mm tubes	red	100	9.400 312
5 mm tubes	green	100	9.400 313
5 mm tubes	yellow	100	9.400 314
5 mm tubes	blue	100	9.400 316



3 NMR Tube Rack, PP

Polypropylene rack with carrying handles features an upper deck with holes and a lower deck support for tube ends. Stackable. For 72 tubes with 3 or 5mm diameter. Dimensions (L x W x H): 213 x 115 x 222 mm.

Type	PK	Cat. No.
NMR Tube Rack	1	9.301 065



1

1 LLG-Glass-Syringes, borosilicate glass

With brown graduations. Sterilisable up to 134 °C.

Capacity ml	Material Cone	Nozzle type	PK	Cat. No.
1	Glass	Luer-Slip	1	6.272 088
2	Glass	Luer-Slip	1	6.272 089
5	Glass	Luer-Slip	1	6.272 090
10	Glass	Luer-Slip	1	6.272 091
20	Glass	Luer-Slip	1	6.272 092
50	Glass	Luer-Slip	1	6.272 093
1	Metal	Luer-Lock	1	6.272 094
2	Metal	Luer-Lock	1	6.272 095
5	Metal	Luer-Lock	1	6.272 096
10	Metal	Luer-Lock	1	6.272 097
20	Metal	Luer-Lock	1	6.272 098
50	Metal	Luer-Lock	1	6.272 099

2

2 LLG-Disposable syringes, 3-parts, PP, non-sterile, bulk

- Barrel: PP, Plunger: PP and Polyisoprene rubber
- Smooth flow, tight, high transparency barrel
- Latex-free, pyrogen-free, DEHP-free, non-toxic
- Non-sterile, bulk packed in box of 500
- Defined safety stop to avoid accidental pull-out of plunger
- Suitable for all syringe filters with Luer connection

Capacity ml	Nozzle type	PK	Cat. No.
2	Luer-Slip	500	6.267 267
5	Luer-Slip	500	6.267 268
10	Luer-Slip	500	6.267 269
20	Luer-Slip	500	6.267 270
2	Luer-Lock	500	6.286 616
5	Luer-Lock	500	6.286 617
10	Luer-Lock	500	6.286 618
20	Luer-Lock	500	6.286 619

3

3 Chromatographic columns, PTFE-/or Valve Stopcock, borosilicate glass 3.3

Chromatography columns with socket and with frit.
Manufactured from borosilicate glass 3.3 which is resistant to heat and almost all chemicals.
NS necks are in compliance with DIN 12242 standards.

Description	Capacity ml	Int. diam. mm	Length mm	PK	Cat. No.
without frit NS 14/23	15	10	200	1	4.008 398
without frit NS 29/32	125	20	400	1	4.008 399
without frit NS 29/32	430	30	600	1	4.008 400
with frit (P=0) NS 14/23	15	10	200	1	4.008 401
with frit (P=0) NS 14/23	25	10	300	1	4.008 402
with frit (P=0) NS 14/23	35	15	200	1	4.008 403

4

4 Glass wool

Extra fine. In packs as outlined below.

Capacity g	PK	Cat. No.
1000	1	9.114 310

5

5 Quartz wool

Silica. Fibre thickness 4 µm to 12 µm.

Capacity g	PK	Cat. No.
500	1	9.114 331

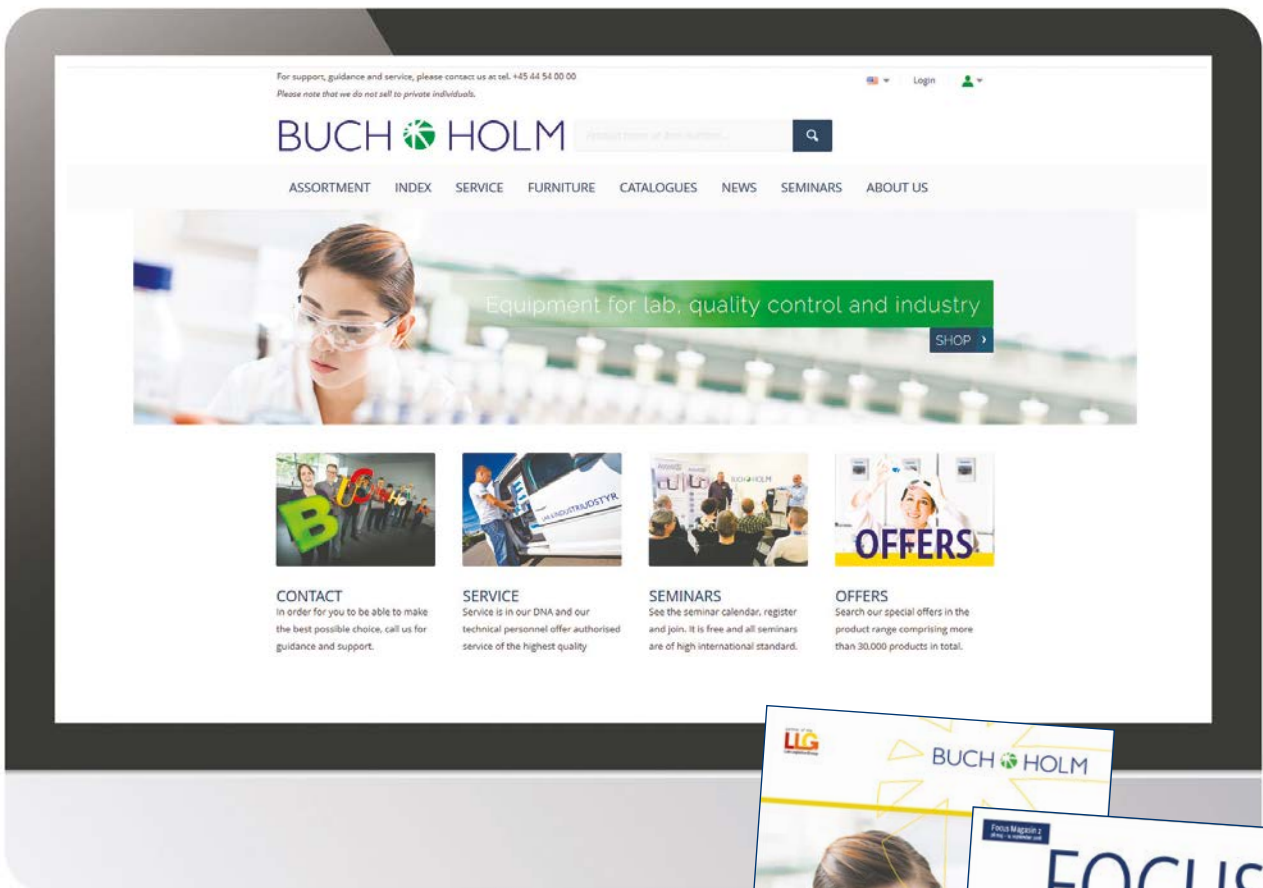

Visit us at www.buch-holm.dk
or www.buch-holm.se

Order free catalogues
or see it online



WEBSHOP

At our webpage you will quickly and easily find the products you are looking for among more than 30,000 products. Log in as a user and get more advantages. See prices and stock, download leaflets, manuals etc. and get access to your own page where you can see your orders, etc.

www.buch-holm.dk or www.buch-holm.se

BUCH HOLM

partner of the



Lab Logistics Group

Buch & Holm A/S
Marielundvej 39
2730 Herlev
Danmark

Tlf. 44 54 00 00
Fax 44 92 31 00
b-h@buch-holm.dk
www.buch-holm.dk

Buch & Holm
Box 10058
200 43 Malmö
Sverige

Tel. 040 - 30 50 30
Fax 040 - 30 50 39
b-h@buch-holm.se
www.buch-holm.se

