

Operating Instructions for the **RST Rheometer**



INSTRUMENTATION & SPECIALTY CONROLS DIVISION
11 Commerce Boulevard, Middleboro, MA 02346-1031 USA
TEL 800-628-8139 or 508-946-6200 FAX 508-946-6262
www.brookfieldengineering.com

Table of Contents

I	Introduction.....	4
I.1	Models of the RST Rheometer	5
I.2	Rheometer System Configuration	6
I.2.1	RST-CC Rheometer	6
I.2.2	RST-SST Rheometer	7
I.2.3	RST-CPS Rheometer.....	8
I.2.4	Computer System with Rheo3000 Software	9
I.3	Set-Up, Safety, and Instrument Care.....	10
I.3.1	Safety.....	10
I.3.2	Transportation and Unpacking.....	10
I.3.3	Operating Environment.....	10
I.3.4	General Handling and Operation Safety.....	11
I.3.5	Set-up	12
I.3.6	Assembly of Additional Devices.....	16
I.3.7	Printer Connection	19
I.3.8	Computer Connection	20
I.3.9	Cleaning.....	20
I.3.10	Maintenance	20
II	Standalone Mode.....	22
II.1	Quick Start: Run Single	22
II.2	Touchscreen and Menu System	29
II.3	Edit.....	32
II.3.1	Units	32
II.3.2	Measuring Systems	33
II.3.3	User Management	36
II.3.4	Edit Program	39
II.3.5	Explorer.....	56
II.4	Settings	60
II.4.1	Time	60
II.4.2	Counter	60
II.4.3	Zeroing	61
II.4.4	Barcode	61
II.4.5	Memory.....	62
II.4.6	Self Test.....	62
II.4.7	Temperature	62
II.4.8	USB Port	63
II.4.9	Language	64
II.4.10	RS232 Port	65
II.4.11	Service.....	65
II.4.12	About	65
II.4.13	Display.....	66
II.4.14	Export Options	66
II.5	Run Program 1 to 11.....	66

III Measuring Systems and Sample Preparation.....	67
III.1 Preparing Samples for use with the RST-CC and RST-SST Rheometers.....	67
III.1.1 Measurement Directly in the Sample Container	68
III.1.2 Measurement with the Sample in the Measuring System.....	69
III.1.3 Measurement with the FTKY3 Temperature Control Device.....	70
III.1.4 Measurement Using the ME3 Cone/Plate and Plate/Plate Adapter.....	73
III.2 Preparing Samples for use with the RST-CPS Rheometer	74
IV Trouble Shooting	78
Appendix A: Technical Data	79
Appendix B: Gap Setting Procedure for the RST-CPS Rheometer.....	80
Appendix C: Calibration Check.....	84
Appendix D: Symbols for Test Parameters and Units of Measurement	86
Appendix E: Data Sheets for Standard Measuring Systems	87
Appendix F: Measuring in Brabender Units (BU)	92
Appendix G: Instrument Dimensions	93
Appendix H: Online Help and Additional Resources.....	97
Appendix I: Warranty Repair and Service	98

I Introduction

The RST Rheometer is a rotational, controlled-stress rheometer used in quality control, product development and research. The measuring drive developed for this instrument utilizes a high-precision dynamic drive system with optical encoder for absolute position measurement of spindle deflection.

There are two basic methods of measurement available with the RST Rheometer:

- Rotational measurement under controlled shear rate
- Rotational measurement under controlled shear stress

The RST Rheometer has all the functionality of a standard Brookfield rotational viscometer, performing rotational tests with pre-set speed or shear rate. The RST Rheometer is powerful for its additional ability to perform tests with a pre-set torque or shear stress and measure the resulting shear deformation of the test substance via angular deflection of the measuring element. The RST Rheometer's unique controlled stress capabilities can be used for experiments such as the precise measurement of the yield point of a test material without a need to shear the substance or the measurement of creep behavior of a material and its recovery after shearing.

In addition, the RST Rheometer is equipped with a powerful motor with a usable torque range of 0.01 to 100 milli-Newton-meters. As a result, the RST Rheometer is appropriate for rheological measurements over a wide range of test material viscosities.

The RST Rheometer has the following features of performance:

- Digital control of rotational speed, shear rate, torque or shear stress
- Pre-designed measurement programs for analysis of viscosity flow curves, creep and recovery behavior, yield stress, and thixotropic properties
- Automatic adjustment of control parameters during measurement
- Direct indication of measured and calculated values of speed, shear rate, torque, shear stress, viscosity, temperature, and time
- Graphical display of measured results in real time
- Internal storage of data including test parameters, measured values, and calculated values
- User interface via touch screen display
- Quick-connect coupling system for easy spindle attachment
- Barcode reader for automatic spindle recognition
- USB port for connection to printer, computer or USB flash drive
- Serial interface (RS232-C) for connection to a computer
- Operation in standalone mode via touch screen display or with a computer system running Rheo3000 application software
- DC power supplied by an AC/DC adapter

Standard delivery of the RST Rheometer includes the following:

- Assembled RST Rheometer
- AC/DC adapter and power cord
- Operating Instructions
- Certification of Test
- Brookfield's Rheo3000 Software (30-day trial)
- USB-RS232 Adapter
- RS232 Cable
- PC-USB Cable (A-B)
- Set of interface protectors for USB-A, USB-B, RS232, and Pt100 ports
- Courtesy Package of RST Series Rheometer Screen Protectors
- Display Pen
- USB Flash Drive

Measuring systems and accessories are not part of the standard delivery of the RST Rheometer and must be ordered according to the user's measuring requirements.

The following additional services are available to support the use of the RST Rheometer:

- Start-up Assistance
- Instrument Training
- Rheo3000 Software Training
- IQ OQ PQ (Installation, operation, and performance qualification)

I.1 Models of the RST Rheometer

This manual addresses all models of the RST Rheometer. When using the operating instructions provided by this manual, it is important to understand which model of the RST Rheometer is being used. To identify the exact model of an RST Rheometer, inspect the instrument's part number (PN). Every instrument has its part number listed on a label on the back of the instrument. Alternatively, the part number can be checked from the touch screen menu by entering the Settings menu and selecting the About icon. (See Section II.4.12.)

Available models of the RST Rheometer are as follows:

RST-CC Touch Rheometer:

The RST-CC is a coaxial cylinder rheometer with DIN geometries for single point QC test or full rheological profiling.

RST-SST Touch Rheometer:

The RST-SST is a soft-solids tester for pastes, slurries, and materials with particulates.

RST-CPS Touch Rheometer:

The RST-CPS is a cone-plate / plate-plate rheometer used for small sample volumes and a wide range of shear rates. The RST-CPS is available with either manual (MS) or automatic (HS) gap setting.

The RST-CPS has four options for temperature control:

- RST-CPS-FH for use with a circulating temperature bath (-20°C to 200°C)
- RST-CPS-PA with Peltier air temperature control (20°C to 180°C)
- RST-CPS-PO with Peltier oil temperature control (0°C to 180°C)
- RST-CPS-EH with electrical heating for temperature control (40°C to 250°C)

Part numbers for RST Rheometers are formatted as follows:

RST – model – temperature control option – gap setting option – 1N - XN

For example, a CPS model with Peltier air temperature control and automatic gap setting has the part number RSTCPSPAHS1N. Because the CC and SST models do not have temperature control or gap setting options, the last 6 characters of these models' part numbers are always NNNN1N. The final 2 characters – XN – identify the power cord configuration. The letter "X" will change according to the country in which the instrument is used.

I.2 Rheometer System Configuration

I.2.1 RST-CC Rheometer



Figure I-1

Components:

- | | |
|-----------------------------------|------------------|
| 1 Rheometer head with touchscreen | 5 Barcode reader |
| 2 Measuring spindle coupling | 6 Clamp handle |
| 3 Seat flange for sample cup | 7 Stand |
| 4 Stand base plate | 8 Leveling screw |

The basic configuration for the RST-CC Rheometer includes:

- Instrument as shown above
- Power unit (AC/DC adapter)

Measuring systems and accessories are not part of the standard delivery of the RST Rheometer and must be ordered according to the user's measuring requirements. Refer to Appendix E for details on available measuring systems.

Measurement Elements and Accessories that are used with the RST-CC Rheometer include:

- Coaxial cylinder measuring systems
- Special measuring systems such as vane spindles
- Temperature sensor Pt100 (PN: PT-E)
- Water jacket for temperature control with coaxial cylinder measuring systems and certain vane spindles (PN: FTKY3)
- KE cooling device for use during high temperature measurements $>90^{\circ}\text{C}$ in order to protect the rheometer head from extreme temperatures (PN: RSS-105)
- ME3-CP/PP device for use with cone/plate or plate/plate measuring systems (PN: RSS-96)
- Circulating temperature bath (PN: TC-550 or TC-650)
- Holding device for convenient support of water jacket or ME3 device (PN: RST-92CPA)
- Dymo Label Writer 450 printer (PN: GV-1050)
- Computer system
- Rheo3000 software

I.2.2 RST-SST Rheometer

The RST-SST Rheometer shares the same basic components as the RST-CC Rheometer, with the following additional components as shown in the figure below.



Figure I-2

Components:

- | | |
|---------------------------------------|----------------------------|
| 1 Extension bellows | 6 Operating handle |
| 2 Clamp handle | 7 Fastening claw |
| 3 Lower position clamp for work plate | 8 Thumb screw |
| 4 Work plate | 9 Upper seat of work plate |
| 5 Barcode Reader | 10 Leveling screw |

The basic configuration for the RST-SST Rheometer includes:

- Instrument as shown above, including work plate
- Power unit (AC/DC adapter)

Measuring systems and accessories are not part of the standard delivery of the RST Rheometer and must be ordered according to the user's measuring requirements. Refer to Appendix E for details on available measuring systems.

Measurement Elements and Accessories that are used with the RST-SST Rheometer include:

- Vane spindles
- Coaxial cylinder measuring systems
- Temperature sensor Pt100 (PN: PT-E)
- Water jacket for temperature control with coaxial cylinder measuring systems and certain vane spindles (PN: FTKY3)
- KE cooling device for use during high temperature measurements $>90^{\circ}\text{C}$ in order to protect the rheometer head from extreme temperatures (PN: RSS-105)
- ME3-CP/PP device for use with cone/plate or plate/plate measuring systems (PN: RSS-96)
- Circulating temperature bath (PN: TC-550 or TC-650)
- Holding device for convenient support of water jacket or ME3 device (PN: RST-92CPA)
- Dymo Label Writer 450 printer (PN: GV-1050)
- Computer system
- Rheo3000 software

I.2.3 RST-CPS Rheometer



Figure I-2

Components:

- | | |
|---|---|
| 1 Rheometer Head | 6 Touch Screen Display |
| 2 Barcode Reader | 7 Measuring Spindle Coupling |
| 3 Spindle (Cone or Plate) | 8 Lever (not available on auto gap model) |
| 4 Bubble Level | 9 Measuring Bottom Plate |
| 5 Hose Connectors (RST-CPS-FH model only) | 10 Leveling Screw |

The basic configuration for the RST-CPS Rheometer includes:

- Instrument as shown above without Cone or Plate spindle
- Power unit (AC adapter)

Measuring systems are not part of the standard delivery of the RST Rheometer and must be ordered according to the user's measuring requirements. Refer to Appendix E for details on available measuring systems.

Measurement Elements and Accessories that are used with the RST-CPS Rheometer include:

- Cone/plate measuring systems
- Plate/plate measuring systems
- Solvent trap for use with highly volatile test materials (PN: RSTRAP)
- Thermal barrier for superior temperature control in heated systems (PN: RSTRAPS or RST91SS)
- KE cooling device for use during high temperature measurements $>90^{\circ}\text{C}$ in order to protect the rheometer head from extreme temperatures (PN: RSS-105)
- Circulating temperature bath for use with CPS-FH model (PN: TC-550 or TC-650)
- Dymo Label Writer 450 printer (PN: GV-1050)
- Computer system
- Rheo3000 software

I.2.4 Computer System with Rheo3000 Software

The computer system and the Rheo3000 software are optional and allow for the automation of measuring procedures, modeling and analysis of measured data, and report printout. The computer system when running Rheo3000 software is capable of controlling up to three RST Rheometers simultaneously.

The computer system consists of a PC with the following minimum system requirements:

- CPU with at least 1.5 GHz frequency
- 1 GB RAM (primary storage)
- 2.5 GB free fixed-disk capacity
- Operating system Microsoft (32bit or 64bit) Windows Vista, 7, 8, or 10
- Mouse and keyboard
- VGA graphic adapter with 1024 x 768 resolution and monitor
- 2 USB ports for rheometer and temperature accessory control
- Application software package Rheo3000

The application software for the RST Rheometer (Rheo3000 software package) is available separately and is not required for the operation of the RST Rheometer. In the following cases, however, it is highly recommended:

- Extensive rheological analyses
- Graphical evaluation
- Evaluation using mathematical models
- Automated measurements
- Specific requirements (e.g. FDA Title 21 CFR Part 11)
- Research and development

I.3 Set-Up, Safety, and Instrument Care

I.3.1 Safety

This operating manual uses the following safety notes:



Danger!

“**Danger!**” indicates a situation of immediate danger which may result in severe injuries as well as damage to property if ignored.



Caution!

“**Caution!**” indicates a situation which may result in minor injuries or damage to property if ignored.

Read this operating manual carefully, follow all instructions provided, and observe all safety notes in order to ensure the proper and safe use of this measuring instrument. If you have any questions, please contact AMETEK Brookfield Technical Support or an authorized dealer.

I.3.2 Transportation and Unpacking

Always transport the RST Rheometer in its original carton. Protect against bumps and shocks. Save the original shipment container for future use (i.e. returning the instrument to AMETEK Brookfield or your local authorized dealer for calibration service.)

Check the instrument for transport damage after unpacking. If any transport damage is detected when unpacking the instrument, please inform the carrier and contact AMETEK Brookfield or your local authorized dealer. The cause for shipping damage should be resolved before any use of the instrument. Do not begin use of a measuring instrument that shows evidence of damage.



Caution!

When unpacking the RST Rheometer, the shipment container will include:

- Assembled RST Rheometer
- Power unit (AC/DC adapter)
- Operating Instructions
- Certification of Test
- Brookfield’s Rheo3000 software (30-day trial)
- USB-RS232 adapter
- RS232 cable
- PC-USB cable (A-B)
- Set of interface protectors for USB-A, USB-B, RS232, and Pt100 ports
- Courtesy package of RST Rheometer Screen Protectors
- Display pen
- USB Flash Drive

Additional accessories ordered with the RST Rheometer such as measuring systems and temperature control elements are packaged and shipped in a separate shipment containers.

I.3.3 Operating Environment

Find a comfortable, convenient work place for the installation of the RST Rheometer. The instrument should be placed upright on a stable, level table. There should be enough room to place the instrument, measuring systems, measuring substances, and peripheral devices (e.g. printer, computer, and bath/circulator). A grounded AC plug outlet is needed to operate the RST Rheometer.

The RST Rheometer's operating environment should be indoors and away from any extreme or heavily fluctuating ambient conditions.

Make sure that the RST Rheometer is not exposed to:

- Heavy dirt or dust
- Direct sun radiation
- Objects that emit strong heat (e.g. heating radiators)
- Objects with a strong electromagnetic field (e.g. loudspeakers, motors etc.)
- Liquids or corrosive chemicals



Additionally, be sure that the following ambient conditions are maintained:

- Temperature between +10°C and +40°C
- Relative air humidity between 20% and 80%

I.3.4 General Handling and Operation Safety

I.3.4.1 Moving the RST Rheometer

To move the RST-CC or RST-SST models short distances (i.e. during assembly), brace the rheometer head against your chest using one hand to support the rheometer measuring head and one hand to support the instrument by its stand. Never lift the instrument by the measuring system or its coupling. Protect the instrument against heavy bumps, vibrations, or shocks that might impair the rotation of the coupling. Use a rolling cart for transportation whenever possible.

To move the RST-CPS model short distances (i.e. during assembly), first protect the instrument by inserting the black foam rubber stopper between the rheometer head and instrument base and by inserting the shipping pin behind the instrument. (Refer to Section I.3.5.3, Figures I-7 and I-8 for help.) During transportation, hold the instrument only by its base. Never hold the instrument by the measuring head to carry it. Never lift the instrument by the measuring system or its coupling. Protect the instrument against heavy bumps, vibrations, or shocks that might impair the rotation of the coupling. Use a rolling cart for transportation whenever possible.



I.3.4.2 Safety During RST Rheometer Operation

If this instrument is used in a manner not specified by Brookfield, the instrument may be at risk of being damaged.

- The RST Rheometer should only be operated by trained users.
- It is recommended that all operators wear protective goggles and gloves.
- Never operate or run the measuring instrument when the instrument or power supply components (e.g. main cable) are damaged.
- Ensure that substances placed under test do not release poisonous, toxic, or flammable gases at the temperatures, which they are subjected to during the testing.
- If using a temperature control system, do not touch any components (such as water jacket, hoses, measurement system) under 5°C or over 40°C. Do not disconnect any hoses when operating in this temperature range.
- Switch the measuring instrument off and disconnect the main plug when:
 - in service or repair
 - moving the measuring instrument
 - in danger or an emergency



I.3.5 Set-up

The following section provides setup information for each model of the RST Rheometer. Please refer to the appropriate section for information specific to the RST-CC, RST-SST, or RST-CPS models.

I.3.5.1 RST-CC Setup

Height Adjustment:

To adjust the height of the stand, release the clamp handle and gently raise the stand to the desired height. Hold the rheometer head close to the stand for best control. When the desired height is achieved, fasten the clamp handle finger-tight again.

Electrical Connections:

Connections for the electrical components of the RST Rheometer are located on the back of the instrument, as shown in Figure I-4 below.

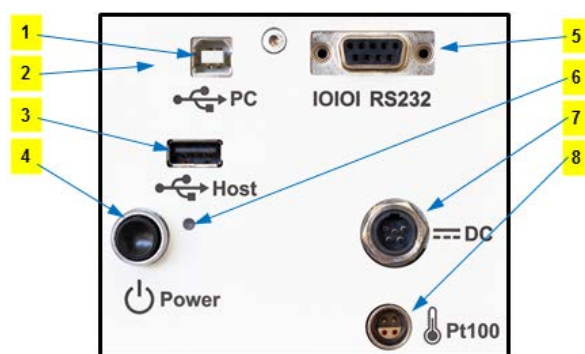

Figure I-4

- | | | | |
|---|----------------------|---|--------------------------|
| 1 | PC (USB) | 5 | RS 232 port |
| 2 | LAN (network) | 6 | ON / OFF control light |
| 3 | USB stick or printer | 7 | Power unit (AC adapter) |
| 4 | ON / OFF button | 8 | Pt100 temperature sensor |

Connect or disconnect any cables from the RST Rheometer only while the instrument is turned off.



I.3.5.2 RST-SST Setup

Height Adjustment:

The RST-SST Rheometer is designed to perform viscosity measurements on test materials in their original packing containers. The rheometer head is raised and lowered in order to change or clean measuring systems between tests without the need to move the test sample container. To raise or lower the rheometer head, first loosen the clamp handle on the left side, and then use the operating handle on the right to move the instrument to the desired position. After height adjustment, fasten the clamp handle finger-tight again.

Mounting and Removing the Work-Plate:

The RST-SST Rheometer is shipped with the work plate already assembled, however some users may choose to remove the work plate for specific tests or for cleaning. Additionally, the work plate can be mounted at two different heights in order to accommodate test material containers of varying sizes.

The complete work plate set up uses the pieces labeled in Figure I-5.

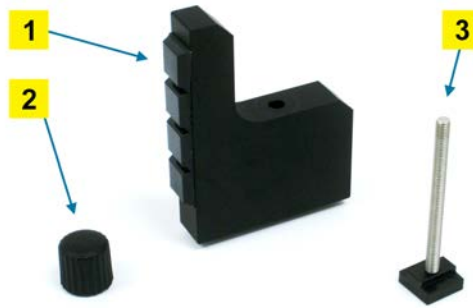

Figure I-5

- | | | | |
|---|----------------|---|--------------------------------|
| 1 | Fastening claw | 3 | Threaded rod and sliding block |
| 2 | Thumb screw | | |

To remove the work plate:

- Unscrew the two spigot nuts, which fasten the work plate to the instrument stand.
- Slide the work plate away from the instrument in order to remove it.
- To remove a sliding block, first unscrew and remove the thumbscrew.
- Remove the threaded rod from under the work plate, freeing the fastening claw.

To mount the work plate:

- First assemble the fastening claws. Put the threaded rod through a work plate slot from underneath. Be sure that the sliding block attached to the threaded rod sits inside the work plate slot.
- Slide a fastening claw over the threaded rod so that the tallest part of the fastening claw faces inward and the raised section on the bottom of the fastening claw sits in the work plate slot.
- Use the thumb wheel to screw the fastening claw down finger-tight.
- Repeat for each fastening claw.
- Place the work plate into the upper or lower seat by pushing it in laterally until it stops.
- Screw the work plate to the stand finger-tight using the two spigot nuts.

Electrical Connections:

Connections for the electrical components of the RST Rheometer are located on the back of the instrument, as shown in Figure I-6.

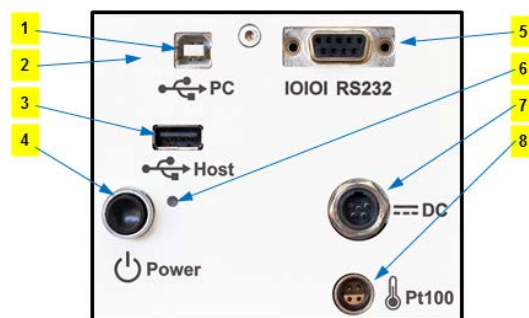

Figure I-6

- | | | | |
|---|----------------------|---|--------------------------|
| 1 | PC (USB) | 5 | RS 232 port |
| 2 | LAN (network) | 6 | ON / OFF control light |
| 3 | USB stick or printer | 7 | Power unit (AC adapter) |
| 4 | ON / OFF button | 8 | Pt100 temperature sensor |

Connect or disconnect any cables from the RST Rheometer only while the instrument is turned off.



Caution!

I.3.5.3 RST-CPS Setup

Removing Safeguards:

To remove the safeguards, pull out the shipping pin (see Figure I-7). Pull the lever to raise the instrument head. Remove the black foam rubber used for shipping protection (see Figure I-8). Save both the shipping pin and the foam rubber block for future shipping purposes.



Figure I-7

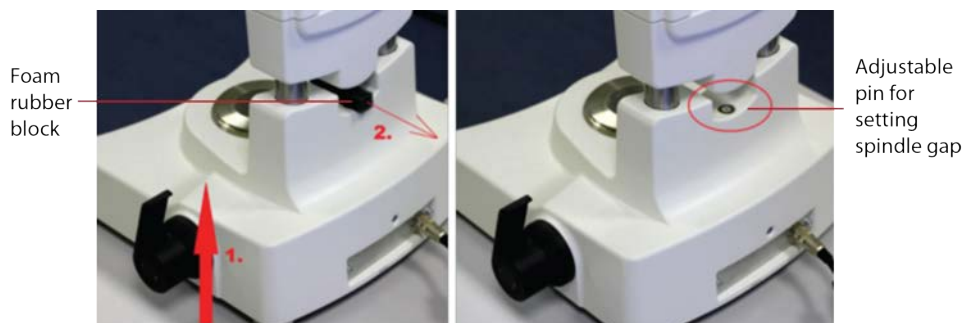

Figure I-8

Electrical Connections:

Connections for the electrical components of the RST-CPS Rheometer are located on the back of the instrument, as shown in Figure I-9 below.

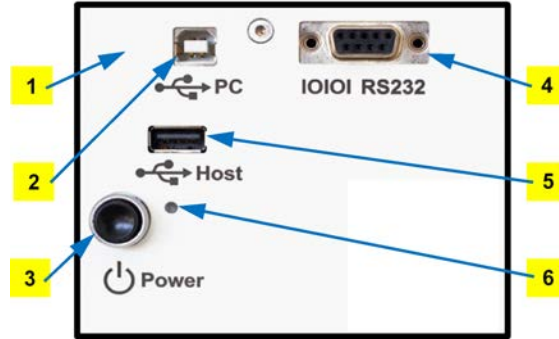

Figure I-9

- | | |
|-------------------|--------------------------|
| 1 LAN (network) | 4 RS 232 port |
| 2 PC (USB) | 5 USB stick or printer |
| 3 ON / OFF button | 6 ON / OFF control light |

Connect or disconnect any cables from the RST Rheometer only while the instrument is turned off.



Temperature Sensor:

The temperature sensor Pt100 is built into the measuring plate of the instrument. The temperature is measured continuously and is displayed on the touch screen display alternately with the date.

I.3.5.4 AC/DC Adapter:



The AC adapter is used to power the RST Rheometer. Do not use any other device to supply the RST Rheometer with power than the AC adapter of IP class 4/2 delivered by Brookfield.

Always connect the AC adapter to a properly grounded socket. To avoid electric shock or damage to system components, always use a properly grounded plug to connect the AC adapter.

Connecting the AC adapter:

- Insert the connecting socket of the power cord into the AC adapter until the plug locks into place.
- Insert the socket of the DC cable into the “DC” connector on the back of the instrument and fasten it finger-tight.
- Plug the power cord into a grounded mains socket.
- Turn the RST Rheometer on.

Be sure to observe the following instructions:

- Never reach into any interface of the AC adapter or touch any of its contact pieces.
- The AC adapter should always lay flat and uncovered.
- Position cables and AC adapter in a way to ensure that no one will stumble over them.
- The AC adapter and the cables must never get into contact with liquids.
- The AC adapter should not remain plugged in when the DC cable is disconnected from the back panel of the instrument.

I.3.6 Assembly of Additional Devices

This section describes the assembly of the KE cooling device, the FTKY3 temperature control device (water jacket), the ME3-CP/PP measuring device, and the Thermosel temperature control device.

I.3.6.1 KE Cooling Device



Figure I-10

Components:

- 1 KE cooling device 2 Hose connections

The KE cooling device (PN: RSS-105) is required whenever the RST Rheometer is operated with measuring systems beyond the temperature range of +90°C. The KE cooling device allows for safe operation by protecting the rheometer bearings from extreme temperatures. Liquid from a circulating bath flows through the cooling channel of the device. The KE cooling device is compatible with all models of the RST Rheometer.

The RST Rheometer should never be operated with measuring systems beyond the temperature range of -20°C to +180°C. Special design for operation of instrument outside this range requires approval by Brookfield.



Assembly of the KE cooling device:

- 1.) Turn the RST Rheometer off with the power button on the back of the instrument.
- 2.) Slide the cooling device KE onto the RST Rheometer from below and tighten the thread to hold the device in place.
- 3.) Fasten the hoses of the cooling circuit (i.e. circulating temperature bath) to the KE cooling device using the quick-fitting hose couplings. To connect a hose, push the coupling sleeve slightly back, insert the hose connector, and let the coupling go. The hose will be fastened, without screwing or turning, by locking in. Pull lightly to check if the hoses fit tightly.

I.3.6.2 FTKY3 Temperature Control Device (Water Jacket)

The FTKY3 water jacket is shown assembled on an RST-CC Rheometer in Figure I-11:



Figure I-11

Components:

- | | | | |
|---|--|---|---------------------------------------|
| 1 | Outlet hose connection for circulating fluid | 4 | Threaded ring for mounting flange |
| 2 | Pt100 temperature sensor | 5 | Fluid circulation chamber |
| 3 | Inlet hose connection for circulating fluid | 6 | Threaded ring for securing sample cup |

The FTKY3 temperature control device (PN: FTKY3) allows for controlled temperature experiments with coaxial cylinder measuring systems. Sample cups designed for use with the FTKY3 fit inside the water jacket, and the test material temperature is regulated using a circulating fluid supplied by a circulating temperature bath (PN: TC-550 or TC-650). The water jacket has a Pt100 temperature sensor built into the body of the device in order to report the test material temperature. The FTKY3 temperature control device is compatible with the CC and SST models of the RST Rheometer.

Do not use the FTKY3 temperature control device with circulating fluid temperatures over +90°C without the KE cooling device. Operating beyond this temperature range exposes the rheometer to extreme temperatures, which may damage the instrument. If using the KE cooling device (described in Section I.3.6.1), it is safe to operate the FTKY3 temperature control device with circulating fluid temperatures in the range of +90°C to +180°C. When performing tests with circulating fluids beyond +90°C, do not start flow to the FTKY3 temperature control device before cooling liquid flows through the KE cooling device. This prevents exposing the rheometer to extreme temperature.



Caution!

Typical thermostat liquids for use with the FTKY3 temperature control device are:

- Deionized water mixed with glycol for operation between -10°C to +90°C
- Thermostat oil for operation between -20°C to +180°C

Suitable thermostat liquids can be obtained from AMETEK Brookfield or an authorized dealer.

Set the upper temperature limit of the circulating temperature bath to +90°C if using water and to +180°C if using oil.



Caution!

Assembly of the FTKY3 temperature control device:

- 1.) Turn the RST Rheometer off with the power button on the back of the instrument.
- 2.) If the KE cooling device is to be used, mount it first, according to the instructions in Section I.3.6.1.
- 3.) Secure the FTKY3 water jacket to the RST Rheometer with the threaded ring (#4 in Figure I-11).
- 4.) Connect hoses from a circulating temperature bath to the FTKY3 quick-fitting couplings, as shown in Figure I-11. To connect a hose, push the coupling sleeve slightly back, insert the hose connector, and let the coupling go. The hose will be fastened, without screwing or turning) by locking in. Pull lightly to check if the hoses fit tightly. Be sure to fasten the correct hoses to the correct fittings such that circulating fluid enters the water jacket from the bottom hose and exits through the top hose. This ensures proper fluid circulation.
- 5.) Connect the FTKY3's built-in Pt100 temperature sensor to the back panel of the RST Rheometer using the cable supplied with the FTKY3.
- 6.) Turn on the RST Rheometer.

Instructions for preparing a sample with the FTKY3 water jacket are provided in Section III.1.3.

I.3.6.3 ME3 Measuring Device (Cone/Plate Adapter)

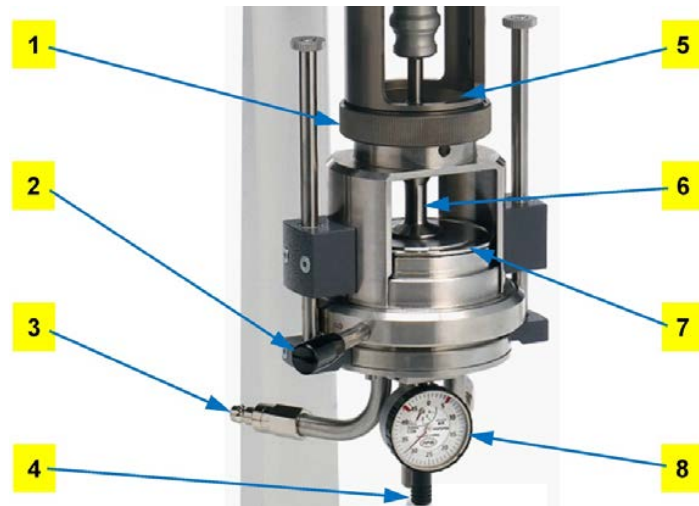

Figure I-12

Components:

- | | | | |
|---|---------------------------------------|---|-----------------------|
| 1 | Threaded ring for mounting flange | 5 | Guide pin |
| 2 | Quarter-turn fastener | 6 | Spindle |
| 3 | Hose connectors for circulating fluid | 7 | Measuring table |
| 4 | Adjusting screw | 8 | Gauge for gap setting |

The ME3 measuring device (PN: RSS-96) enables the use of cone/plate or plate/plate measuring systems with the RST-CC and RST-SST Rheometers. The cone/plate adapter has built-in temperature control capabilities via circulating fluid supplied by a circulating temperature bath (PN: TC-550 or TC-650). The ME3 measuring device has a Pt100 temperature sensor built into the body of the device in order to report the test material temperature.

Do not use the ME3 measuring device with circulating fluid temperatures over +90°C without the KE cooling device. Operating beyond this temperature range exposes the rheometer to extreme temperatures, which may damage the instrument. If using the KE cooling device (described in Section I.3.6.1), it is safe to operate the ME3 measuring device with circulating fluid temperatures in the range of +90°C to +180°C. When performing tests with circulating fluids beyond the -10°C to +90°C range, do not start flow to the ME3 measuring device before cooling liquid flows through the KE cooling device. This prevents exposing the rheometer to extreme temperatures.



Typical thermostat liquids for use with the ME3 measuring device are:

- Deionized water mixed with glycol for operation between -10°C to +90°C
- Thermostat oil for operation between -20°C to +180°C

Suitable thermostat liquids can be obtained from AMETEK Brookfield or your local authorized dealer.

Set the upper temperature limit of the circulation temperature bath to 90°C if using water and to 180°C if using oil.



Assembly of the ME3 measuring device:

- 1.) Turn the RST Rheometer off with the power button on the back of the instrument.
- 2.) If the cooling device KE is to be used, mount it first, according to the instructions in Section I.3.6.1.
- 3.) Set the ME3 measuring device on the rheometer flange from below and check to see if the guide pin of the measuring plate lies in the groove of the mounting flange of the RST Rheometer. Tighten the thread.
- 4.) If temperature control is to be used, connect hoses from a circulating temperature bath to the ME3 quick-fitting couplings. To connect a hose, push the coupling sleeve slightly back, insert the hose connector, and let the coupling go. The hose will be fastened, without screwing or turning, by locking in. Pull lightly to check if the hoses fit tightly.
- 5.) Connect the ME3's built-in Pt100 temperature sensor to the back panel of the RST Rheometer using the cable supplied with the ME3.
- 6.) Turn on the RST Rheometer.

Instructions for setting the gap, loading a sample, and performing measurements with the cone/plate adapter are provided in Section III.1.4.

I.3.6.4 Thermosel Temperature Control Device

An assembled Thermosel temperature control device is shown on an RST-SST Rheometer in Figure I-13:



Figure I-13

The Thermosel temperature control device (PN: HT RS DIN 81) allows for controlled temperature experiments up to +300°C with coaxial cylinder measuring system using DIN 81 spindle.

I.3.7 Printer Connection

The DYMO LabelWriter® printer (PN: GV-1050) allows for the automatic printing of measurements taken by the RST Rheometer without PC support. This printer can be connected directly to the USB Host port of the RST Rheometer. Use the “Report” feature when designing a measurement program in standalone mode to arrange to print measurement data.

In order to connect the DYMO LabelWriter® printer:

- 1.) Turn the RST Rheometer off with the Power button on the back of the instrument.
- 2.) Insert the printer connecting cable into the USB Host socket on the back panel of the RST Rheometer. A standard USB printer connecting cable can be used to connect the printer. The cable is normally delivered with the printer.
- 3.) Turn the RST Rheometer on again.

The printout of measuring results can only be guaranteed for the printer mentioned above. To use another printer or for extensive prints (e.g. graphs or colored prints), use a PC with the Rheo3000 software and output the results to the printer from the PC.

I.3.8 Computer Connection

If the RST Rheometer is to be operated in remote mode with PC support via the Rheo3000 software package, connect the computer to the instrument using the following procedure:

- 1.) Turn the RST Rheometer off using the Power button on the back of the instrument.
- 2.) Turn the computer system off.
- 3.) Insert either the RS232 or PC-USB interface cable provided by Brookfield into the “RS232” or “PC” socket on the back panel of the RST Rheometer. Do not use any interface cable other than that provided by Brookfield.
- 4.) Connect the other end of the cable to an unoccupied RS232 serial port (e.g. “COM2”) or USB port on the computer.
- 5.) Turn the RST Rheometer and associated computer system on again.



I.3.9 Cleaning

To clean the RST Rheometer:

- Use the supplied cleaning cloth to clean the touch screen display. If necessary, replace the protective foil on the touch screen display. Replacements are available from your AMETEK Brookfield dealer (Part No. RST-3011 – five protective screens and one cleaning clothe).
- Use a dry, clean, soft and nap-free cloth on the housing. Use natural detergent liquids if necessary.
- Do not use chemical products such as strong solvents or strong acids to clean the housing, especially the touch screen display. The paint coat of the RST Rheometer does resist most solvents and weak acids.
- Make sure NO liquid penetrates into the housing (e.g. through the instrument connecting sockets) and into the bearings of the measuring drive. This could result in the destruction of the instrument and void the instrument’s warranty.



I.3.10 Maintenance

The RST Rheometer system is designed for long-term operation.

The user can check measurement accuracy at any time. It is recommended that such measurements be performed with Brookfield viscosity standard fluids (mineral oils). Instructions for this calibration process are detailed in Appendix C.

Important guidelines when checking the instrument’s measurement accuracy include the following:

- Use temperature control
- Select the appropriate measuring system
- Use the Brookfield viscosity standard fluid recommended for the chosen measuring system

- Carry out measurements at the following pre-set M (‰ torque) values: 125‰, 250‰ and 375‰
- Read viscosity values from the display on the RST Rheometer and compare with the known fluid viscosity
- Refer to Appendix C for complete details on calibration check procedures

In case of instrument failure (or deviation from the mineral oil viscosity value), or should the instrument require repair, please contact AMETEK Brookfield or your local authorized dealer.

Only authorized service personnel may work on the control electronics, all accessories, the measuring device, as well as the AC Adapter and all electric circuits and connections! Do not make any technical modifications on the instrument! Any modification will result in voiding of the instrument's warranty!



II Standalone Mode

The following chapter summarizes the operation and the menu system of the RST Rheometer for the performance of manual measurements without PC support.

II.1 Quick Start: Run Single

This quick start guide is intended to provide the user with instructions on the “Run Single” test option using the touch screen display system. The Run Single test option allows the user to quickly set up and run different rheological tests. In order to ensure safe and proper use of this instrument to its fullest capacity, the user should read the operation manual in its entirety.

- 1.) **Assemble** the RST Rheometer on a sturdy, level workbench. (Refer to Section I.3 for installation help.)

Start-up:

- 2.) **Connect the instrument to power** via the AC adapter. (The main power supply is located behind the rheometer head for the CC and SST models and behind the rheometer base for the CPS model.) Ensure that no spindle is attached to the instrument, and then use the **Power** button to turn on the rheometer.
- 3.) The touch screen display will turn on and display the start screen, shown in Figure II-1, while the instrument conducts a self-test. On the right side of the start screen the instrument model (CC, SST, CPS-F, CPS-P, or CPS-E), part number (i.e. PN: RSTSSTNNNN1N), and the instrument's serial number (i.e. SN: 7120001) are listed.

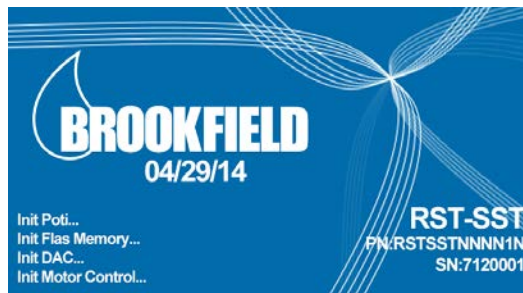

Figure II-1

- 4.) If User Management is not activated, the system will display the home screen following completion of the self-test. The home screen will appear as in Figure II-2.



Figure II-2

If User Management is active, the next two screens will prompt for the user name and password. (Be aware that passwords are case sensitive. Refer to Section II.3.3 for additional information on User Management.)

For the CPS-P model, if the “Hold Temperature” feature is active and set $\geq 50^{\circ}\text{C}$ (122°F), the screen will display “Do you want to start with this temperature?”. Choose “Yes” or “No”.

- 5.) If it is the first use of the rheometer, it will be necessary to zero the system. Touch the **Zeroing** icon. Of the three options on the following screen, choose the most appropriate for the intended measuring programs. (Refer to Section II.4.3 for details on the zeroing process.) After the zeroing is complete, there is an option to either save the zeroing data or cancel. **Press OK** to save. The system will return to the home screen.
- 6.) To perform a simple, one-step test on a sample, touch the **Run Single** icon.

Prepare the test:

- 7.) The following screen is shown in Figure II-3. The check box labeled “Wait for temperature” instructs the instrument to wait for the system to reach an assigned temperature before beginning testing. If no Pt100 temperature sensor is interfaced with the instrument, the instrument will not wait to achieve the specified temperature; however it will include the specified temperature in the test parameters data.

The RST-CPS with Peltier or electric temperature control displays a second check box labeled “Hold Temperature” which instructs the instrument to maintain the set temperature after the test is complete. Use this feature when performing multiple tests in a row at the same set temperature. **Check the boxes appropriate for the experiment, and then press OK.** If the “Wait for Temperature” option was left unchecked, continue to step 10.



Figure II-3

- 8.) The following screen will appear as shown in Figure II-4. **Enter the desired start temperature.** If using the “Wait for Temperature” option in the absence of a Pt100 temperature sensor, enter the observed sample temperature. **Press OK.** If operating without a Pt100 sensor, continue to step 10.



Figure II-4

- 9.) The system will wait until the assigned start temperature is achieved while displaying the screen shown in Figure II-5. T set is the assigned Start Temperature from step 8, and T actual is the temperature detected by the Pt100 temperature sensor. Once the set temperature is reached, the display will automatically continue to the next step.



Figure II-5

If the assigned start temperature is the same as the actual temperature, the screen in Figure II-5 will be skipped.

- 10.) If the measuring system has not yet been attached, the next screen will display the message **“Plug in measurement system and close coupling!”** In order to continue, the spindle coupling must be closed. (If using the RST-CC or the RST-SST, the sample and any additional devices should be prepared at the same time as the measurement system. If using the RST-CPS model, the spindle should be attached at this time, but the sample will be loaded in a future step after setting the cone-plate gap.)
- 11.) The following screen confirms the measurement system to be used. If automatic spindle recognition fails, continue to step 12. If the scanner successfully reads the measurement system barcode, the system will display the screen shown in Figure II-6. The green plus symbol on the right is the Add icon. Press the **Add** icon to add the measuring system to the instrument’s stored list of measuring systems, and **enter the measuring system information** as described in Section II.3.2 on measuring systems. If the measurement system information is already stored, there will be no Add icon. Press **OK** and continue to step 13.

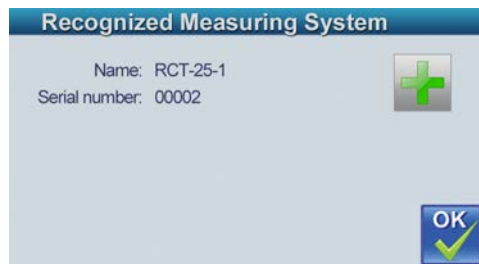

Figure II-6

- 12.) If the scanner does not successfully read the measurement system barcode or there is no barcode, the system will display a warning that the spindle recognition failed. Acknowledge the warning by pressing **OK**, and the system will proceed to a screen similar to the one depicted in Figure II-7, which shows a stored list of possible measurement systems. Use the green arrows to scroll up and down the list. **Choose the correct measurement system** and press **OK** to confirm. (If the measurement system in use is not listed, refer to Section II.3.2 on managing measurement systems.)

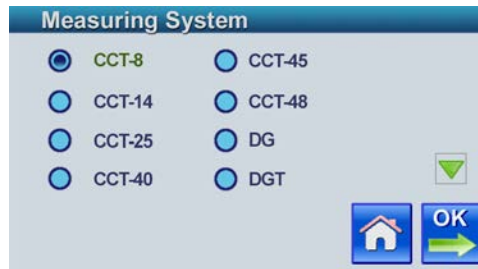

Figure II-7

13.)The next screen appears as shown in Figure II-8. **Select the controlled variable** to be used in the experiment and press **OK**. For example, in order to run a static yield stress test, choose to control the shear stress variable.

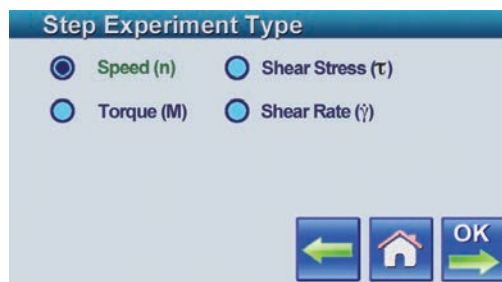

Figure II-8

14.)On the following screen shown in Figure II-9 below, **enter the desired start value and end value** of the controlled variable selected in the previous step and press **OK**. When the test is run, the rheometer will begin testing at the start value, increment the controlled variable linearly throughout the duration of the test, and stop at the end value. This is called a sweep. In order to run a test with a constant controlled variable instead of a sweep, enter the same value for both the start and end parameters.

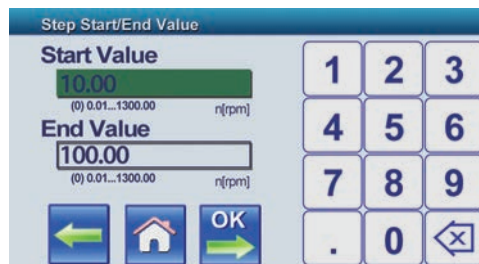

Figure II-9

15.)**Enter the desired number of data points to be taken and the total time** over which to run the experiment on the following screen, as shown in Figure II-10. Press **OK**.

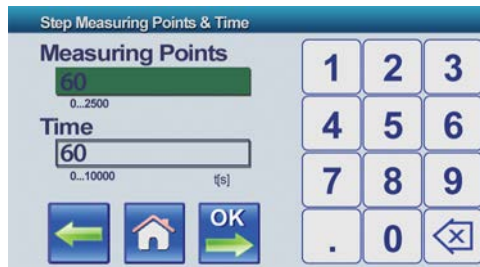

Figure II-10

- 16.) On the screen titled “Substance (sample material)”, which is shown in Figure II-11, **enter a sample name** then **press OK**. The maximum number of alpha numeric characters is 25.



Figure II-11

- 17.) If using the RST-CPS, the following screen will ask if the user would like to set the cone-plate / plate-plate gap, as shown in Figure II-12. Choose **Yes** unless the gap has already been set for the selected measuring system in a previous test. **Follow the gap setting instructions** detailed in Appendix B.

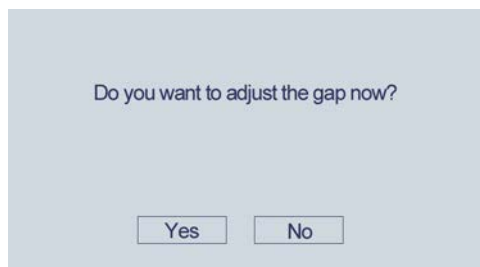

Figure II-12

- 18.) If using the RST-CPS, after setting the gap **prepare the sample**. Refer to the instructions in Section III.2.

Start Measurement:

- 19.) If the “Wait for Temperature” option had been selected earlier, and a Pt100 sensor is connected to the instrument, the system will wait for the measuring system and sample to come to temperature.
- 20.) The test will automatically begin. During the test execution, the screen shown in Figure II-13 shows the data for the most recent measurement point taken, including viscosity, shear rate, shear stress, and temperature on the left side and time, RPMs, per mille torque, and the measuring point on the right side. The Stop button can be used at any time during the test to cease testing. When the Stop button is used, measurement points collected before stopping are saved.

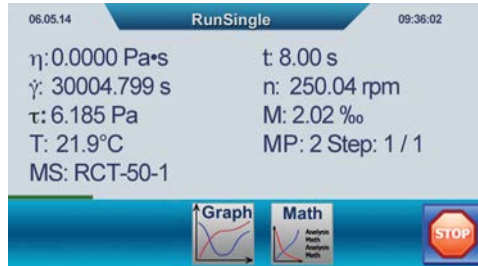

Figure II-13

21.) If the maximum torque (100 mNm) is exceeded during measurement, e.g. by a stop of the measuring drive under full load or by a rise in viscosity caused by hardening processes, the electronic safety devices will be activated in order to prevent instrument failure. In such cases, the instrument will abort the measuring program and any data from the program will be lost.

Review Data:

22.) The Graph and Math view formats are also available during and after active testing. The Graph view format presents data as shown in Figure II-14 shown below, plotting time on the x-axis, viscosity on the y-1 axis, and temperature on the y-2 axis. Additionally, the Math format shows the minimum viscosity value, the maximum viscosity value and the average of all viscosity values in the top half of a table. The bottom half remains empty for the Run Single program.

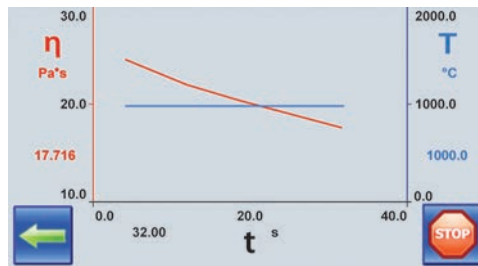

Figure II-14

23.) When the test has finished, the word “finished” will appear in the lower right hand corner of the display screen, as shown in Figure II-15. Two additional options become available at the bottom of the screen. The first icon on the lower left hand corner of the display is the Review Data button. Additionally, on the right side is a Repeat Test button indicated by a circular arrow, which runs the program, again according to the same parameters for the original test. There is also an OK button that returns the user to the home screen.

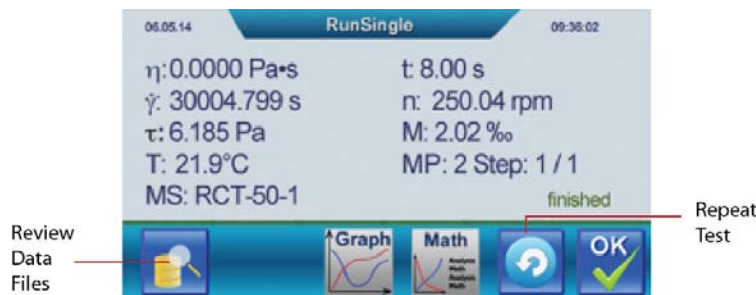

Figure II-15

24.) To review the measurement data taken, **touch the Review Data button**. The first screen reviews general test program information. Press **OK**. The second screen displays the test parameters. Press **OK**. The following screen shows three icons: Math, QC, and Report. For the RunSingle program, these options are not defined. Press **OK**. The next screen allows the user to review each individual measurement point using the left and right green arrows. Additionally, the Table, Graph, and Math view formats are available for review. The Graph and Math view formats are the same as those available during and immediately after testing. The additional Table view format shows values for time, viscosity, shear rate or speed, shear stress or torque, and temperature for each measuring point, as shown in Figure II-16. The data available from the Review Data button is also accessible using Explorer, which is described in Section II.3.5.

t/s	η /Pa's	$\dot{\gamma}$ /s ⁻¹	τ /Pa	T/°C
320.0	1	85.37	1512.31	—
36.0	1	89.00	1515.91	—
40.0	1	92.61	1520.27	—
44.0	1	96.24	1523.26	—
48.0	1	99.87	1527.43	—

Figure II-16

The user can recognize the columns in Figure II-16 by touching individual parameters at the top of the table. A drop down menu appears and allows the user to choose the specific parameter of interest.

25.) After completing the RunSingle program and before returning to the home screen, the RST-CPS will ask the user if the measuring system or sample will be changed. If the user selects **Yes**, the display will instruct the user to release the spindle coupling. When there is sample material on the plate, always **release the spindle coupling before raising the head** so as to prevent damage to the rheometer.



Caution!

II.2 Touchscreen and Menu System

All user input in standalone mode is done via touchscreen. The touchscreen doubles as both an input and output device. The touchscreen is resistive, meaning that it responds to light pressure. Tap lightly with a finger to select the desired option on the touchscreen. Tap and drag your finger across the touchscreen to perform a drag-and-drop operation. Instead of a finger, the stylus that is provided with the instrument can be used to operate the touch screen. Replace the protective foil on the display when damage or heavy wear is in evidence.

 After turning on and waiting for the RST to complete the self-test, the home screen menu will appear. Tapping at the stylized house icon at any time will return the user to the home screen.

 Use the arrow keys up or down to turn pages within an active menu.

The Status Bar at the top right of the touch screen provides information relating to the time (as configured by the user), the coupling, and various connections to the RST Rheometer. The figure below describes the purpose of each icon on the Status Bar.



Figure II-17

- | | | |
|---|----------------------|--|
| 1 | Coupling | This icon is green when the coupling is open and red when the coupling is closed. |
| 2 | RS232 | This icon is green when there is a connection to a PC through the RS232 port. An "R" appears over the icon when the instrument is communicating with the Rheo3000 software through this port. |
| 3 | USB-B PC | This icon is green when there is a connection to a PC through the USB-B PC port. An "R" appears over the icon when the instrument is communicating with the Rheo3000 software through this port. |
| 4 | LAN | This icon is green when there is a connection to a LAN network. |
| 5 | USB-A Host | This icon is green when there is a connection to a USB flash drive or printer. |
| 6 | Time and Temperature | The time and the temperature reported by a Pt100 sensor are displayed, alternating every 3 seconds. |

The home screen is the main menu for the touch screen menu system and is shown in Figure II-18.

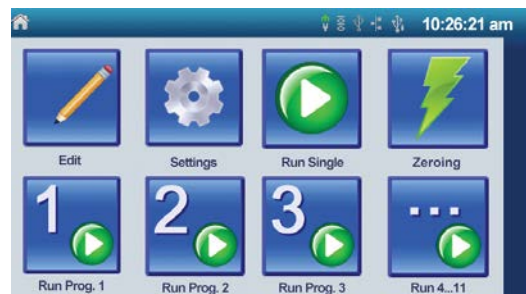



Figure II-18

The following is a schematic representation of the touch screen menu system for the RST Rheometer, starting with the home screen menu options.

 → Edit

 → Units

 → Measuring Systems

 → Users

 → Edit Program

 → Explorer

 → Settings

 → Time

 → Counter

 → About

 → Barcode

 → Memory

 → Self-Test

 → Temperature

 → USB

 → Language

 → German

 → English

 → Chinese

 → Japanese

 → Portuguese

 → Spanish

 → Polish

 → French

 → Russian

 → RS232

 → Service

 → Export Options

 → Display

 → Run Single

 → Zeroing

 → Run Program 1

 → Run Program 2

 → Run Program 3

 → Programs 4 to 11

 → Run Program 4

 → Run Program 5 (similar representation for programs 6-11)

II.3 Edit

Press the **Edit** icon from the home screen menu. The Edit menu appears as shown in Figure II-20.

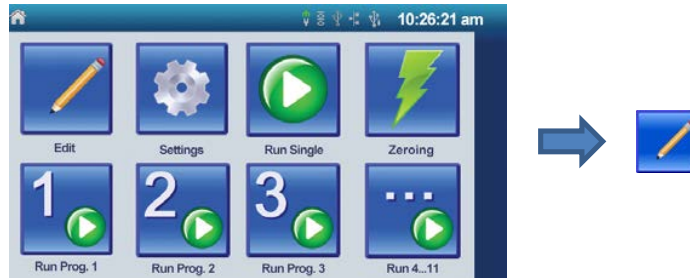

Figure II-19



Figure II-20

From the Edit menu, the user can:

- Change units for viscosity and temperature measurement
- Manage measuring systems
- Manage users
- Design and change test programs
- View and manage measured data

II.3.1 Units

To change the default units for viscosity and temperature, **press the Units icon** from the Edit menu.

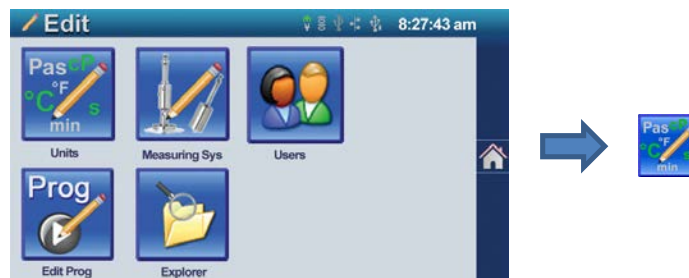

Figure II-21

To change the units, **press the radio button in front of the desired unit** shown in Figure II-22.



Figure II-22

The available units for dynamic viscosity (η) are:

- Pascal-seconds (Pa*s)
- milliPascal-seconds (mPa*s)
- Poise (P)
- centiPoise (cP)

The available units for temperature (T) are:

- degrees Celsius (°C)
- degrees Fahrenheit (°F)

Press **OK** to save after making changes.

II.3.2 Measuring Systems

To manage stored data on measuring systems, press the Measuring Sys icon from the Edit menu.

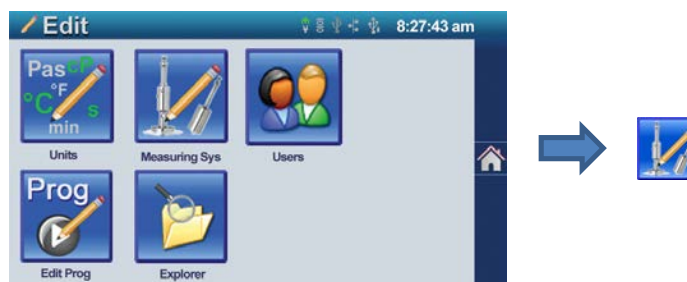

Figure II-23

The first screen, shown in Figure II-24, allows the user to select the types of measuring systems that are visible when assigning a measuring system during a measuring program. This is helpful when certain measuring systems types are seldom or never used. For example, an RST-CPS user may choose to hide the cylinder, double gap, and vane measuring systems. To “Hide” measuring systems, which are seldom used, tap the check box in front of the measuring system type to remove the check mark.

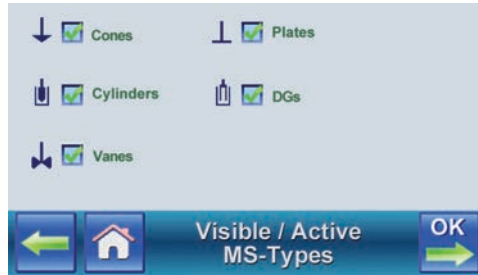

Figure II-24

Press OK to continue to a stored list of measuring systems show in Figure II-25. Measuring system types, which are designated hidden on the previous screen, will still be included in this list. They are only hidden when the user is assigning a measuring system within a measuring program. Note that the list of measuring systems consists of several pages. Move up or down through the list with the green arrows on the right side of the screen.



Figure II-25

Using the three icons centered at the bottom of the screen, measurement systems can be:

- added (Plus symbol)
- edited (Pencil)
- deleted (Waste Paper Basket)



To add a new measuring system, press the Add icon. Plug in the measuring system to be added and close the coupling. The barcode scanner will read the measuring system barcode. Press OK to continue. A series of screens will collect important information on the new measuring system. Added measuring systems are appended to the end of the list shown in Figure II-25.



To edit an existing measuring system, select the measuring system to be edited and touch the Edit icon. A series of screens will present the existing information on the measuring system and allow the user to make changes.



To erase a stored measuring system, select the measuring system to be deleted and press the delete button. On the next screen, confirm whether to delete the measuring system.

When adding a new measuring system or editing an existing one, the following series of screens is presented. (This procedure is also used when adding a measuring system from the Settings > Barcode menu or adding a system while preparing a RunSingle program.)

- 1.) **Enter the name of the measuring system** using the keyboard to enter up to 25 alphanumeric characters (see Figure II-26). It is good practice to include information on the type of measuring system and its dimensions in order to create a meaningful name. **Push OK to confirm** the name and continue.



Figure II-26

- 2.) **Select the measuring system type** from the screen shown in Figure II-27. The “Visible” checkbox determines whether users selecting a measuring system within a measuring program can see this measuring system listed. **Press OK** to continue. Press the Back icon at any time to correct previous input errors or check entries.

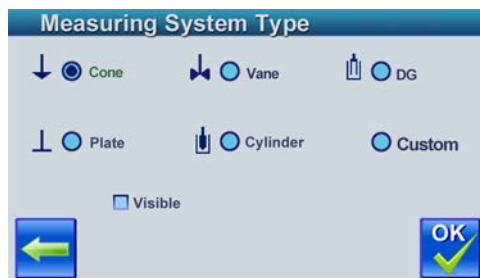

Figure II-27

- 3.) **Enter the shear rate factor (K-Gamma) and the shear stress factor (TauPromill)** using the numeric keyboard (Figure II-28). This information can be found on the spindle data sheet for the measuring system. If the barcode of the measuring system being added has been scanned, default values for K-Gamma and Tau Promill may already be entered, however the user should update these values with the exact values from the spindle data sheet. **Press OK** to continue.

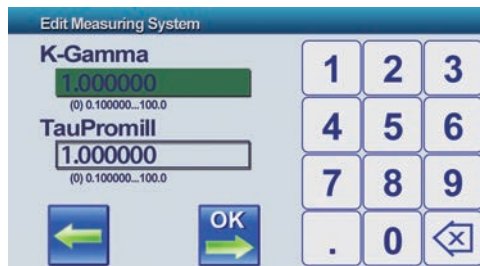

Figure II-28

- 4.) For cone measuring systems, **enter the cone truncation height** in μm on the next screen (Figure II-28). **Press OK** to continue.

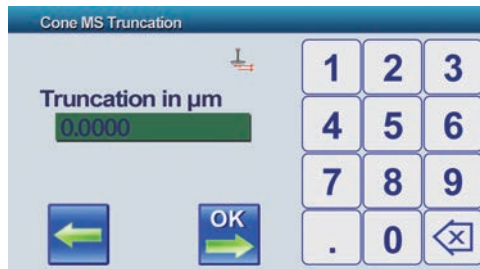

Figure II-29

- 5.) Then **enter the sample volume** required for the measurement in milliLiters (mL) on the next screen (Figure II-30).

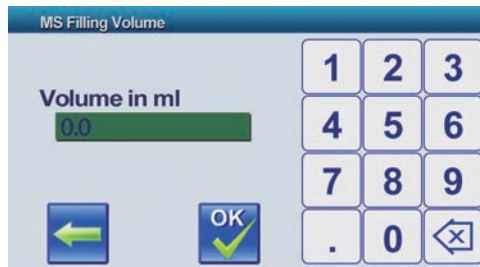

Figure II-30

- 6.) **Save the entered value by pressing OK.** This completes and saves the measurement system information.

II.3.3 User Management

When the User Management feature is active, users are authorized to perform specific tasks by the system administrator. A username, password, and accompanying set of user rights are assigned to each user by the system administrator. This feature supports the compliance with requirements in regulated industries, such as 21CFR Part 11 for the pharmaceutical industry, which addresses the controls for user access to the RST Rheometer.

Press the **Users** icon from the Edit menu.

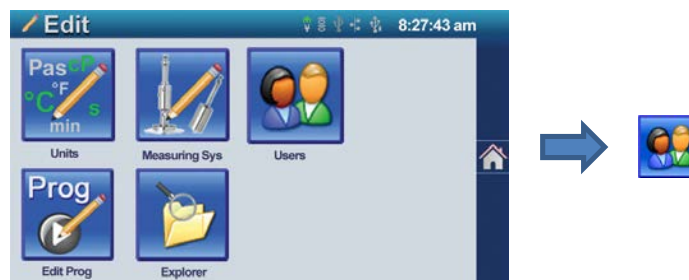

Figure II-31

In order to switch on User Management, check the User Management Active box and press OK (Figure II-32). Only the administrator can switch User Management on or off, and the ADMIN password is required in order to save any change. The administrator can investigate the ADMIN's password from the screen in

Figure II-33. The administrator should take note of this password, as a username and password login will be required upon next startup of the instrument, if User Management is active.



Figure II-32

The next screen is titled Edit User (Figure II-33). This is the screen used by the administrator to add authorized users with specific rights. The ADMIN is automatically created and cannot be deleted, but the ADMIN user information should be reviewed so the administrator can assign themselves a new, secure password.



Figure II-33

Use the three icons at the bottom of the screen to add (Plus symbol), edit (Pencil) and delete (Waste Basket) users.

To add a new user or review and edit an existing user's information:

- 1.) **Press the Plus symbol** to add a user, or **select a user and press on the Edit icon** to edit the user information. On the next screen, **enter the user name** with up to 11 alphanumeric characters. **Press OK** to proceed.



Figure II-34

- 2.) The next screen, shown in Figure II-35, provides choices for user rights. All users are allowed to view program and measuring system information. "Edit" provides the user with the right to create and edit programs, measuring systems, and users. "Delete" provides the user with the right to delete measuring systems or users. **Select the appropriate rights** for the user, and **press OK** to continue.



Figure II-35

3.) The following screen (Figure II-36) lists additional user rights. The user rights are defined below.

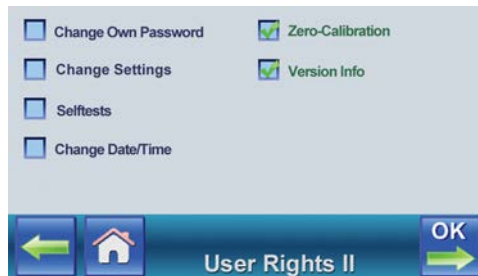

Figure II-36

- Change Own Pwd: Allows a user to change their password.
- Change Settings: Allows the user to access and change Language, RS232, and Display settings.
- Selftests: Allows the user access to self-tests via Settings > Selftest.
- Change Date/Time: Allows the user to set the date and time format via Settings > Time.
- Zero-Calibration: Allows the user to run Zeroing programs from the home screen and from Settings > Zeroing.
- Version Info: Allows the user access to Settings > About.

Assign user rights as appropriate and press OK to proceed.

4.) On the next screen, **assign a password** with up to 10 alphanumeric characters. The user name and password combination is required upon instrument start-up for the user to gain access to the instrument. If the password is changed or being entered for a new user, it will be necessary to enter the password twice. Figure II-37 will be displayed twice. Press the Eye icon on the right side of the password being entered. The password letters will be concealed by an asterisk (*) after two seconds.



Figure II-37

When the RST Rheometer is restarted and User Management has been activated, the first screen to appear after startup is User Name (Figure II-38). This screen is also presented when leaving the Edit users menu after User Management has been activated. Use the down arrow to see the menu of users who have been assigned to the instrument. Choose the appropriate user name and press OK.

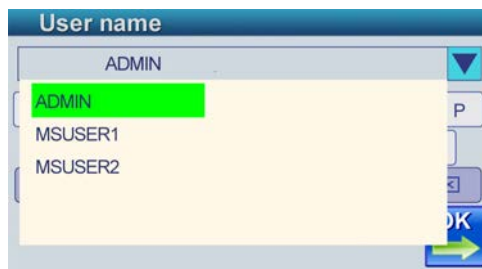

Figure II-38

On the next screen, the same screen as shown in Figure II-37, enter the password for the selected user. Note that the password is case sensitive. The up arrow on the keyboard allows the user to toggle between upper and lowercase keyboards. Push OK to continue to the home screen. The name for the current user will appear on the status bar at the top left of the home screen.

II.3.4 Edit Program

Edit Program allows the user to design 11 stored measuring programs, accessible from the home screen. Programs 1 through 11 offer more flexibility than the RunSingle program in order to provide a detailed and comprehensive evaluation of a sample material. Saved programs allow users to repeat tests without the need to specify the same test parameters before execution of each test. Programs 1 through 11 are capable of running:

- Custom multi-step viscosity tests
- Creep and creep/recovery tests
- SST modulus tests
- Yield tests
- Thixotropy tests

The multi-step viscosity tests can be programmed to function like a series of RunSingle tests. These tests are very flexible in design, and also have additional features including quality control parameters. The other test types are specialized to analyze specific rheological properties. These specialized tests are less flexible than the multi-step viscosity tests, but they can provide quantitative analysis of the specified rheological property. Each of these program types is detailed in the following sections.

To design a measurement program:

- 1.) **Select the “Edit Prog” button from the Edit menu.**

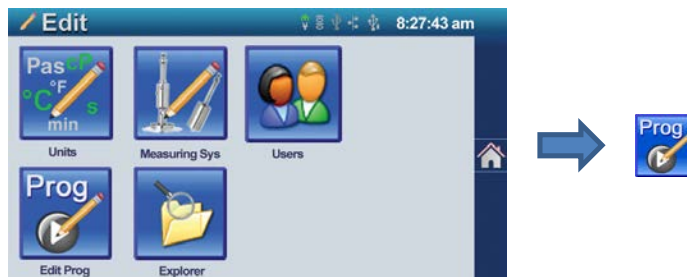

Figure II-39

- 2.) The screen shown in Figure II-40 below will follow. **Select a program to edit and press OK.** Note that it is necessary to scroll down to the next screen in order to access programs 7 through 11.



Figure II-40

- 3.) On the next screen, **set the program name.** The user can choose to keep the default "PROG#" as the name or change the name to something more meaningful. **Press OK.**



Figure II-41

- 4.) On the following screen (Figure II-42), **choose the measuring system** to be used for the test. Use the down arrow to navigate to additional screens with more spindle choices. It is required that the measuring system chosen in this step matches the measuring system used when the program is run. The measuring systems at the beginning of the list are generalized measuring systems, meaning that they are compatible with any recognized spindle with the same geometry as the generalized measuring system. It is helpful to choose a generalized measuring system if the user possesses multiple measuring systems of the same geometry that may be used interchangeably. Even if a generalized measuring system is chosen, when the program is run it will record the serial number of the measuring system used. If the measurement system to be used is not listed, refer to Section II.3.2 on managing measurement systems. **Press OK.**



Figure II-42

- 5.) The next screen (Figure II-43) allows for the selection of viscosity and temperature units to be used during programming and testing. Units for viscosity include Pascal*seconds (Pas),

milliPascal•seconds (mPas), Poise (P) and centipoise (cP). Units for temperature include °C and °F. **Select units and press OK.**



Figure II-43

6.) On the next screen, shown in Figure II-44, **choose the test type.**



Figure II-44

7.) Continue by referring to Sections II.3.4.1 through II.3.4.6 for instructions specific to each test type.

8.) After the test parameters have been set, enter the company name if appropriate or leave the field blank, and **press OK.**



Figure II-45

9.) **Choose whether to prompt for the company name** each time the program executes using the checkbox as shown in Figure II-46. **Press OK** (Figure II-45).

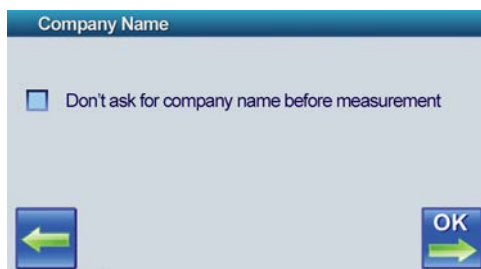

Figure II-46

- 10.) **Enter the name of the sample material** to be used with this program. **Press OK**. The program will be saved and ready for use.



Figure II-47

II.3.4.1 Viscosity

The Viscosity test is the most flexible test type. Users are allowed to design a series of test steps, controlling speed, shear rate, torque, or shear stress. Additional features allow the user to set quality control boundaries, report shear rate, shear stress, and viscosity averages, and arrange data output.

For each measuring point, the Viscosity test reports:

- η , Viscosity
- $\dot{\gamma}$, Shear rate
- τ , Shear stress
- T, Temperature
- t, time
- n, Speed
- M, Torque
- MP, Measuring point
- MS, Measuring system

Additionally, the Graph view plots viscosity data versus time.

To design a Viscosity test program:

- 1) Edit a program as described in the Edit Program Section II.3.4 introduction; **choose the Viscosity test type**, and **press OK**.
- 2) The screen that follows is shown in Figure II-48 below. Test steps are chosen from the right side of the screen and assembled in the program builder on the left. When the program is run, the steps in the program builder are executed sequentially. There are two-step types, Constant and Ramp, and three data management features, Quality Control, Math, and Report. The function of each of the features is described at the end of this

section. Use a drag-and-drop technique to **add steps and features from the right to the program builder on the left**. The maximum number of steps is 10.



Figure II-48

- 3) After a step has been added to the sequence, **double-tap the block** to edit the step's test parameters. Alternatively the user can tap the block to select it, and then touch the Edit icon to edit the step. A black border signifies when a block has been selected.
- 4) The sequence of screens that follows after choosing to edit a program step is analogous to the inputs requested from the RunSingle program. For instructions, refer to the Quick Start guide in Section II.1, which details each test parameter. **Enter the test parameters**.
- 5) After the test parameters regarding temperature options, the screen shown in the Figure II-49 will be presented. **Check each box** in order to enable that feature for the step being designed. Features are added to the program builder separately, but this screen gives each feature permission to use this step's data. **Press OK**. After this step, the user will be returned to the screen in Figure II-48.



Figure II-49

- 6) **Add any data management features** (Report, Math Model, and Quality Control) desired to the program builder. Each of these features is described in detail at the end of this section.
- 7) **Edit features** either by double-tapping the block or selecting it and then pressing the Edit icon.
- 8) When finished designing the program, **press OK**.
- 9) Next, enter the company name if appropriate or leave the field blank, and **press OK**.



Figure II-50

- 10) On the next screen (Figure II-51), choose whether to prompt for the company name each time the program executes. **Press OK.**

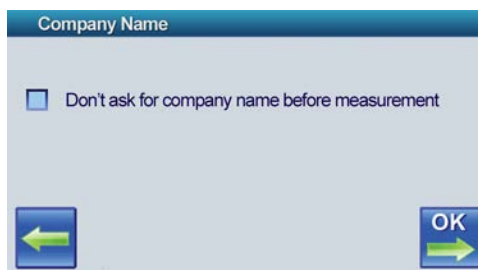

Figure II-51

- 11) **Enter the name of the sample material** to be used with this program. **Press OK.** The program will be saved and ready for use.



Figure II-52

Quality Control:

The Quality Control (QC) function allows for real-time quality control analysis.

To use the QC function, **add the QC block to the program builder** and then **double tap the block to edit** the quality control parameters. The screen that appears is shown in Figure II-53 below. **Enter the target value for viscosity and the tolerance limits in $\pm\%$** around the target value. For example, a target viscosity of 1000 cP and error limits of $\pm 10\%$ would result in quality control limits between 900 cP to 1100 cP. **Press OK.**



Figure II-53

The next screen (Figure II-54), controls an alert, which is sounded by the RST Rheometer whenever the viscosity is outside the prescribed QC limits. To instruct the rheometer to produce a beep any time a measuring point lies outside of the QC limits, **check the “Beep on leaving QC area” box.** Use the sliding scale to set the duration of the alarm beep. The beep time can

range from 0.1 second to 5 seconds. Consider the time interval between measuring points when selecting a beep time. **Press OK.**

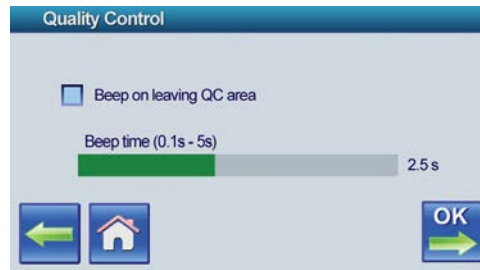

Figure II-54

The Math Model function reports the minimum, maximum, and average values for shear rate, shear stress, and viscosity. These values can be calculated for each step in the program and for the overall test program.

To use the Math Model function, **add the Math block to the program builder** and then **double tap the block to edit** what the Math Model function reports. The screen that appears is shown in Figure II-55 below. The Math function can display the minimum, maximum and average values for shear rate, shear stress and viscosity. These values can be displayed for each step in the program and/or for the overall test program. Check the values and parameters for the Math function to report. **Push OK.**

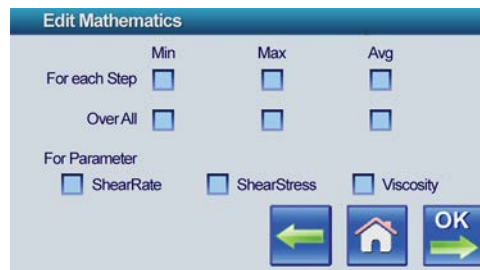

Figure II-55

Report:

The Report function arranges for the automatic output of test data.

To use the Report function, **add the Report block to the program builder** and then **double tap the block to edit** the data output settings. The screen that appears is shown in Figure II-56 below. Output Group 1 provides the choice to send the data through the RST's USB-A port to a flash drive or to a printer. Output Group 2 provides the choice to send the data out the RST's USB-B port or through RS-232 serial port. **Select the appropriate data output locations,** and then **press OK.**

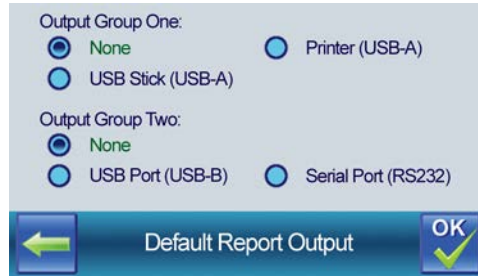

Figure II-56

If the USB Stick is selected, Figure II-58 will be displayed. If the Printer option was chosen for data output, the screen in Figure II-57 will follow. **Select which measuring points to print, and press OK.**

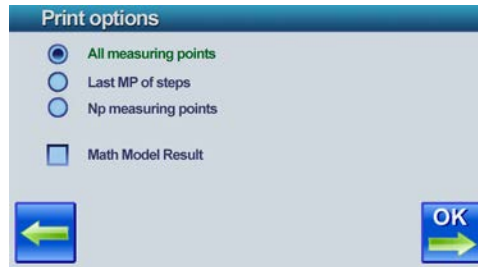

Figure II-57

The following screen (Figure II-58) shows how the test data will appear when printed. To rearrange the data columns, **click on a parameter at the top of a column and use the drop down menu to change the parameter.** Press OK when finished.



Figure II-58

II.3.4.2 Creep

The purpose of the Creep test is to analyze a sample material's ability to deform under a small constant shear stress.

The Creep test produces a constant shear stress and measures the resulting strain, also called shear deformation. Figure II-59 below shows a graph of typical creep behavior for a viscoelastic fluid.

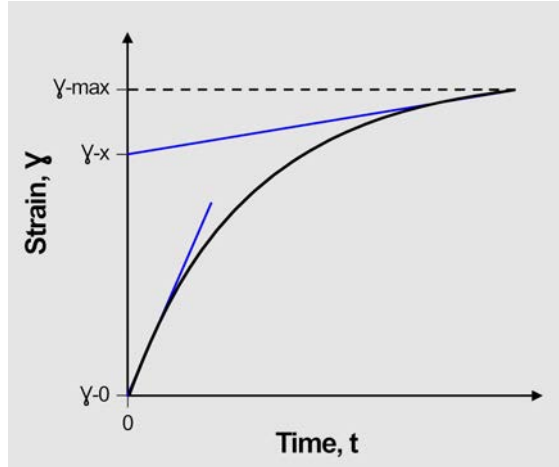

Figure II-59

For each measuring point, the Creep test reports:

- Rate, Shear rate ($\dot{\gamma}$)
- γ , Strain
- γ -0, Instantaneous deformation
- T, Temperature
- t, Time
- E-index, Elastic index
- γ -x, Elastic shear deformation
- MP and Step, Measuring point and step
- MS, Measuring system

The Creep test also reports math model results, which describe the elastic properties of the test material. Math model results are accessed via the Review Data button after a test is completed. The following values are reported in the math model results:

- γ -0
 γ -0 represents instantaneous shear deformation. This value is calculated using a linear regression of the first five measuring points of the test, where γ -0 is the y-intercept of the linear regression line.
- γ -x
 γ -x represents elastic shear deformation. This value is calculated using a linear regression of the final five measuring points of the test, where γ -x is the y-intercept of the linear regression line.
- γ -max
 γ -max represents the maximum shear deformation achieved during the test.
- E-index
 E-index refers to the elastic index of the test material, calculated as the ratio of the elastic deformation to the maximum deformation.

$$E_{index} = \frac{\gamma_x}{\gamma_{max}}$$

Additionally, the Graph view for the Creep test plots strain data versus time. This allows the user to view a graph analogous to the plot in Figure II-59.

To design a Creep test program:

- 1) Edit a program as described at the beginning of the Edit Program section (II.3.4), and **choose the Creep test type**.
- 2) The sequence of screens that follows after choosing the test type is analogous to the inputs requested from the RunSingle program. For instructions, refer to the Quick Start guide in Section II.1, which details each test parameter. **Enter the test parameters**. Tips for choosing test parameters for the Creep test:
 - **Start Value**
The Creep test is a constant shear stress test, so there will be a “Start Value” input but no “End Value” input. An ideal shear stress is below to slightly above the yield stress for the substance.
 - **Measuring Points**
Be mindful that the time between measuring points should be relatively small in order to maximize the accuracy of the γ -0 and γ -x calculations. This program requires a minimum of 0.1 seconds between measuring points, which means that the maximum number of measuring points which can be taken is ten times the step time.
 - **Step Time**
Be sure to allow enough time to fully observe the test material’s elastic behavior. By the end of the test, the shear rate should be relatively constant.
- 3) After the test parameters regarding temperature options, the screen shown in Figure II-60 will be presented. **Check the Report box** in order to arrange for automatic data output after the test. If “Report” is checked, the following series of screens will provide data output options. The report feature functions as described in Section II.3.4.1 on the Viscosity test type. If no data output is needed, leave the box unchecked. **Press OK**.



Figure II-60

- 4) After arranging the report feature, the test parameters are complete. Refer back to the beginning of Section II.3.4 for further instructions.

II.3.4.3 Creep Relaxation

The purpose of the Creep Relaxation test is to analyze a sample material’s ability to deform under constant shear stress (creep) followed by the sample material’s reaction to removal of the constant shear stress (relaxation).

The Creep Relaxation test has two steps. The first step is the creep portion of the test, which is identical to the Creep test from the previous section and produces a constant shear stress in order to measure the resulting strain, or shear deformation. For the second step, the relaxation portion of the test, the shear stress is removed and the strain continues to be measured. Figure II-61 below shows a graph of typical creep-relaxation behavior for a viscoelastic fluid.

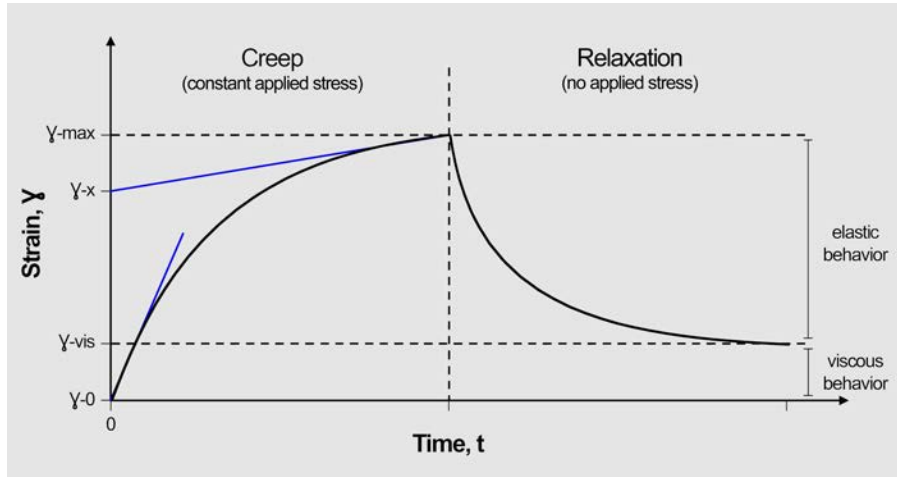

Figure II-61

For each measuring point, the Creep-Relaxation test reports:

- Rate, Shear rate ($\dot{\gamma}$)
- γ , Strain
- γ -0, Instantaneous deformation
- T, Temperature
- t, Time
- E-index, Elastic index
- γ -x, Elastic shear deformation
- MP and Step, Measuring point and step
- MS, Measuring system

The Creep-Relaxation test also reports math model results, which describe the viscoelastic properties of the test material. Math model results are accessed via the Review Data button after a test is completed. The following values are reported in the math model results:

- γ -0
 γ -0 represents instantaneous shear deformation. This value is calculated using a linear regression of the first five measuring points of the creep portion of the test, where γ -0 is the y-intercept of the linear regression line.
- γ -x
 γ -x represents elastic shear deformation. This value is calculated using a linear regression of the final five measuring points of the creep portion of the test, where γ -x is the y-intercept of the linear regression line.
- γ -max
 γ -max represents the maximum shear deformation achieved during the test.
- γ -vis
 γ -vis represents viscous shear deformation, which is the strain detected at the end of the relaxation portion of the test.
- E-index
 E-index refers to the elastic index of the test material, calculated as the ratio of the elastic deformation to the maximum deformation. An elastic index of 0 would indicate no elastic behavior, and an elastic index of 1 would indicate purely elastic behavior.

$$E_{index} = \frac{\gamma_x}{\gamma_{max}}$$

- V-index
V-index refers to the viscous index of the test material, calculated as the ratio of the viscous deformation to the maximum deformation. A viscous index of 0 would indicate no viscous behavior, and a viscous index of 1 would indicate purely viscous behavior.

$$V_{index} = \frac{\gamma_{vis}}{\gamma_{max}}$$

Additionally, the Graph view for the Creep Relaxation test plots strain data verses time. This allows the user to view a graph analogous to the plot in Figure II-61.

To design a Creep-Relaxation test program:

- 1) Edit a program as described at the beginning of the Edit Program section (II.3.4), and **choose the Creep Relaxation test type**.
- 2) The sequence of screens that follows after choosing the test type is analogous to the inputs requested from the RunSingle program. For instructions, refer to the Quick Start guide in Section II.1, which details each test parameter. **Enter the test parameters**. Tips for choosing test parameters for the Creep Relaxation test:
 - Start Value
The Creep Relaxation test is a constant shear stress test, so there will be a “Start Value” input but no “End Value” input. An ideal shear stress is below to slightly above the yield stress of the substance.
 - Measuring Points
This value will be used for each step in the program. That means that if a value of 60 is entered, the creep step will measure 60 points, and then the relaxation step will measure an additional 60 points. Be mindful that the time between measuring points should be relatively small in order to maximize the accuracy of the $\dot{\gamma}$ -0 and $\dot{\gamma}$ -x calculations. This program requires a minimum of 0.1 seconds between measuring points, which means that the maximum number of measuring points which can be taken is ten times the step time.
 - Step Time
This value will also be used for each step in the program. That means that if a step time of 60 seconds is entered, the creep step will run for 60 seconds, and then the relaxation step will run for an additional 60 seconds. Be sure to allow enough time to fully observe the test material’s elastic behavior. By the end of the creep step of the test, the shear rate should be relatively constant. By the end of the relaxation step, the shear rate should be zero, indicating a constant strain and no movement.
- 3) After the test parameters regarding temperature options, the screen shown in the figure below will be presented. **Check the Report box** in order to arrange for automatic data output after the test. If “Report” is checked, the following series of screens will provide data output options. The report feature functions as described in Section II.3.4.1 on the Viscosity test type. If no data output is needed, leave the box unchecked. **Press OK**.



Figure II-62

- 4) After arranging the report feature, the test parameters are complete. Refer back to the beginning of Section II.3.4 for further instructions.

II.3.4.4 SST Modulus

The purpose of the SST test is to analyze a soft-solid's initial change in shear stress as the material deforms at a constant shear rate.

The SST test uses a constant shear rate to deform the sample and measures the resulting shear stress in order to calculate the SST modulus. Figure II-63 below shows a graph of typical fluid behavior for an SST test.

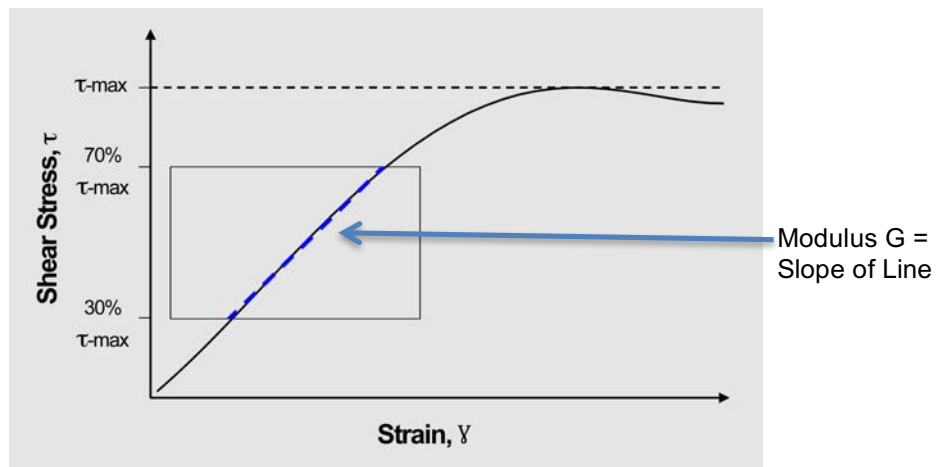

Figure II-63

For each measuring point, the SST test reports:

- τ , Shear stress
- M, Torque
- T, Temperature
- t, Time
- τ max, Maximum observed shear stress
- M max, Maximum observed torque
- MP and Step, Measuring point and step
- MS, Measuring system

The SST test also reports math model results, which describe the SST modulus of the test material. Math model results are accessed via the Review Data button after a test is completed. The following values are reported in the math model results:

- τ -max
 τ -max represents the maximum shear stress observed during the test. τ -max can also arbitrarily be used as a yield stress value for the sample.
- M-max
M-max represents the maximum torque output observed during the test.
- G
G represents the SST modulus. A linear regression of the measuring points where the observed shear stress lies within a range of 30% - 70% of the maximum observed shear stress is performed, and the resulting slope from the linear regression is the reported SST modulus G. Refer to Figure II-63 for a visual representation of how this calculation is performed.

Additionally, the Graph view for the SST test plots shear stress verses strain. This allows the user to view a graph analogous to the plot in Figure II-63.

To design an SST test program:

- 1) Edit a program as described at the beginning of the Section II.3.4 - Edit Program, and **choose the SST test type.**
- 2) The sequence of screens that follows after choosing the test type is analogous to the inputs requested from the RunSingle program. For instructions, refer to the Quick Start guide in Section II.1, which details each test parameter. **Enter the test parameters.** Tips for choosing test parameters for an SST test:
 - Measuring System
The SST test is designed for use with soft-solid sample materials. As a result, the most appropriate measuring system choice is usually a vane spindle.
 - Start Value
The SST test is a constant shear rate test where the shear rate is determined by the chosen speed of rotation. Because this speed will be constant, there will be a "Start Value" input but no "End Value" input. An ideal speed is low enough to maximize the amount of time it takes to achieve steady state value for τ -max but high enough to avoid noisy data. This maximizes the range of data included in the calculation.
 - Measuring Points
Be mindful that the time between measuring points should be relatively small in order to maximize the accuracy of the dynamic modulus calculation. This program requires a minimum of 0.1 seconds between measuring points, which means that the maximum number of measuring points which can be taken is ten times the step time.
 - Step Time
The time should be long enough that the system achieves steady state by the end of the testing period.
- 3) After the test parameters regarding temperature options, the screen shown in the figure below will be presented. **Check the Report box** in order to arrange for automatic data output after the test. If "Report" is checked, the following series of screens will provide data output options. The report feature functions as described in Section II.3.4.1 on the Viscosity test type. If no data output is needed, leave the box unchecked. **Press OK.**

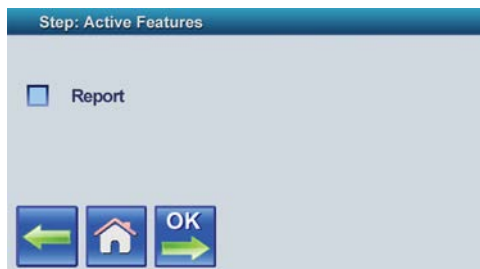

Figure II-64

- 4) After arranging the report feature, the test parameters are complete. Refer back to the beginning of Section II.3.4 for further instructions.

II.3.4.5 Yield

The purpose of the Yield test is to determine the sample material's yield stress.

The Yield test performs a shear stress sweep and measures the resulting strain, also called shear deformation. The program then uses the collected data to calculate the yield stress. Figure II-65 below shows a graph of typical pseudoplastic behavior for a Yield test.

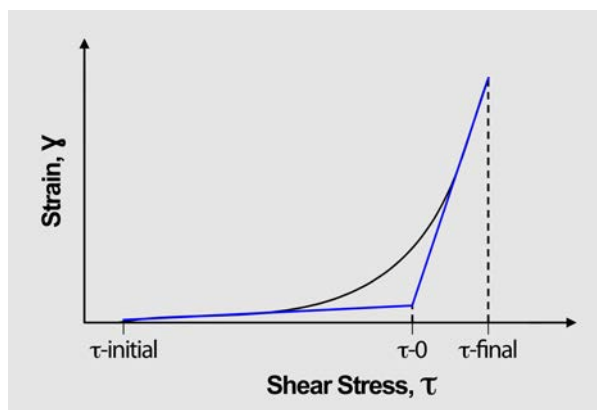

Figure II-65

For each measuring point, the Yield test reports:

- η , Viscosity
- γ , Strain
- τ , Shear stress
- T , Temperature
- t , time
- $\tau-0$, Yield stress
- M , torque
- MP and Step, Measuring point and step
- MS, Measuring system

The Yield test also reports math model results, which report the yield stress of the test material. Math model results are accessed via the Review Data button after a test is completed. Only one value is reported in the math model results for the Yield test:

- $\tau - 0$
 $\tau - 0$ represents the yield stress of the test material. $\tau - 0$ is calculated as the intersection of the secant lines taken at the beginning and end of the shear stress ramp. The secant lines are determined using a linear regression of the first five measuring points of the test for one line and the final five measuring points for the second line. Refer to Figure II-65 for a visual representation of how this calculation is performed.

Additionally, the Graph view for the Yield test plots strain verses time. This allows the user to view a graph similar to the plot in Figure II-65.

To design a Yield test program:

- 1) Edit a program as described at the beginning of the Edit Program section (II.3.4), and **choose the Yield test type.**
- 2) The sequence of screens that follows after choosing the test type is analogous to the inputs requested from the RunSingle program. For instructions, refer to the Quick Start guide in Section II.1, which details each test parameter. **Enter the test parameters.** Tips for choosing test parameters for the Yield test:
 - **Start Value and End Value**
 The Yield test performs a shear stress ramp. In order to maximize the accuracy of the secant calculations, there should be many measuring points both before and after the yield stress is achieved. The range of the shear stress ramp should be chosen with this in mind.
 - **Measuring Points**
 Be mindful that the time between measuring points should be relatively small in order to maximize the accuracy of the secant calculations. This program requires a minimum of 0.1 seconds between measuring points, which means that the maximum number of measuring points which can be taken is ten times the step time.
 - **Step Time**
 When running multiple yield tests for comparison, be sure that the shear stress ramp rate is the same for each test.
- 3) After the test parameters regarding temperature options, the screen shown in the figure below will be presented. **Check the Report box** in order to arrange for automatic data output after the test. If "Report" is checked, the following series of screens will provide data output options. The report feature functions as described in Section II.3.4.1 on the Viscosity test type. If no data output is needed, leave the box unchecked. **Press OK.**



Figure II-66

- 4) After arranging the report feature, the test parameters are complete. Refer back to the beginning of Section II.3.4 for further instructions.

II.3.4.6 Thixotropy

The purpose of the Thixotropy test is to analyze a sample material's thixotropic properties.

This test applies a constant shear rate to the material and measures viscosity over the duration of the test. From this data, automatic calculations are performed analyzing the degree of thixotropic behavior observed as well as the time dependence of observed thixotropic behavior. Figure II-67 below shows a graph of typical behavior for a thixotropic fluid.

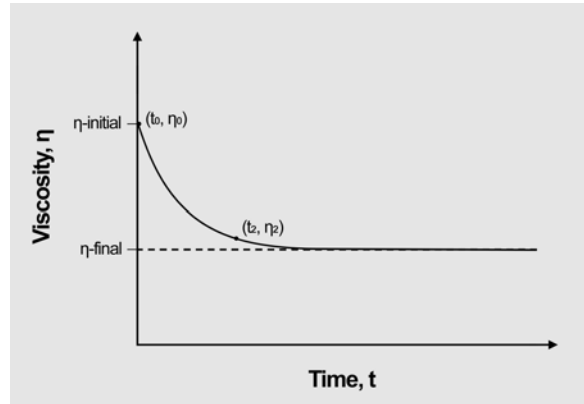

Figure II-67

For each measuring point, the Thixotropy test reports:

- η , Viscosity
- $\dot{\gamma}$, Shear rate
- τ , Shear stress
- T, Temperature
- t, Time
- $\dot{\eta}$, Fractional change in viscosity
- M, Torque
- MP and Step, Measuring point and step
- MS, Measuring system

The Thixotropy test also reports math model results, which describe the thixotropic properties of the test material. Math model results are accessed via the Review Data button after a test is completed. The following values are reported in the math model results:

- Start η
Start η represents the initial viscosity, calculated at the first measuring point of the test.
- End η
End η represents the final viscosity, calculated at the final measuring point of the test.
- $\dot{\eta}$
 $\dot{\eta}$ represents the fractional change in viscosity over the test period.

$$\dot{\eta} = \frac{\Delta\eta}{\eta_{initial}} = 1 - \frac{\eta_{final}}{\eta_{initial}}$$

- Tb

Tb represents the thixotropic breakdown coefficient, which indicates the rate at which the material's thixotropic behavior changes. The breakdown coefficient is calculated using two points. The first is the first measuring point of the test, (t_0, η_0), and the second is a point taken from later in the test, but before steady state is achieved, (t_2, η_2).

$$Tb = \frac{\eta_0 - \eta_2}{\ln(t_2/t_0)}$$

Additionally, the Graph view for the Thixotropy test plots viscosity vs. time. This allows the user to view a graph analogous to the plot in Figure II-67.

To design a Thixotropy test program:

- 1) Edit a program as described at the beginning of the Edit Program section (II.3.4), and **choose the Thixotropy test type**.
- 2) The sequence of screens that follows after choosing the test type is analogous to the inputs requested from the RunSingle program. For instructions, refer to the Quick Start guide in Section II.1, which details each test parameter. **Enter the test parameters**. Tips for choosing test parameters for the Thixotropy test:
 - **Start Value**
The Thixotropy test is a constant shear rate test, so there will be a "Start Value" input but no "End Value" input. The shear rate start value should reflect the conditions under which the test material's thixotropic properties are relevant (i.e. either production or use).
 - **Step Time**
The time should be long enough that steady state is reached by the end of the test.
- 3) After the test parameters regarding temperature options, the screen shown in the figure below will be presented. **Check the Report box** in order to arrange for automatic data output after the test. If "Report" is checked, the following series of screens will provide data output options. The report feature functions as described in Section II.3.4.1 on the Viscosity test type. If no data output is needed, leave the box unchecked. **Press OK**.



Figure II-68

- 4) After arranging the report feature, the test parameters are complete. Refer back to the beginning of Section II.3.4 for further instructions.

II.3.5 Explorer

Test data can be viewed and managed through Explorer.

From the Edit menu, click on the Explorer icon.



Figure II-69

Three folder icons are displayed:

- SD-CARD
This is for use by Brookfield service personnel.
- USBSTICK
This folder will appear if a USB flash drive is connected. Double click on the folder to view the data files that are stored on the flash drive.
- DATA
This folder contains all standalone test data files from the internal memory of the RST Rheometer. Instructions on navigating the Data folder are detailed below. Instructions on transferring files from Data to a USB stick follow.

Navigating a test's data:

- 1) From the Explorer main, screen shown in Figure II-70, double tap the DATA 2 folder.



Figure II-70

- 2) The next screen lists data files that have been stored by the instrument in reverse chronological order. The most recent data file to be generated is listed first. Each file is named with program name, test number, date and time. Date and time format will be displayed according to choices you make in Data and Time settings. Double tap a test in order to look at its data. Test data can also be opened by tapping a test once to select it, then pressing the Open icon that appears on the right. Use the green arrows on the right to scroll through more tests if necessary.

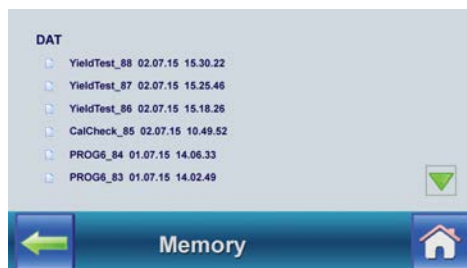

Figure II-71

- 3) An example of the first screen in a data file is shown in Figure II-72. This screen reports the program name, when the test was executed, which company the test was run for, who executed the test, the substance used, the measuring system used, and the number of steps in the program. Press OK to continue to the next screen.



Figure II-72

- 4) The next screen displays the program parameters for each step of the program. When there are multiple steps in the program, use the green arrows on the right to navigate through each step. *For each step, this screen shown in Figure II-73 is displayed with the given program name as the title. This screen lists the step number, the controlled variable (Input Mode), the start and end values of the controlled variable, the step duration, the number of measurement points taken, and the temperature. There is also an additional icon on this screen, the Exit icon. Pressing the exit icon at any time will return the user to the list of stored tests in the DATA folder. Use the OK arrow to continue to the next screen.



Figure II-73

- 5) The screen shown in Figure II-74 allows the user to examine the math model, quality control, and report features used with the program. Touch an icon to examine that feature. Use the OK arrow to continue to the next screen.

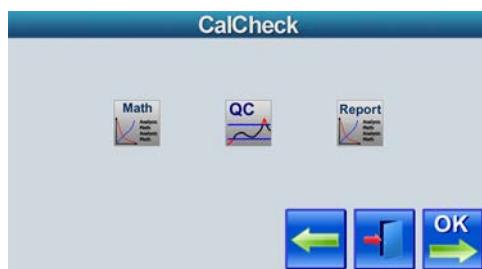

Figure II-74

- 6) The following screen allows the user to view the data for each individual measuring point. Scroll through the measuring points using the green arrows. The user can also view a graph of the data and the math model results using the icons at the bottom of the screen. For RunSingle and Viscosity programs, the math model result is accessed from the Math icon. For specialized programs, the math model results are available through a blue icon with an “equals” sign, as shown in Figure II-75. The table icon is available for RunSingle and Viscosity tests as an additional way to view individual measuring point data.

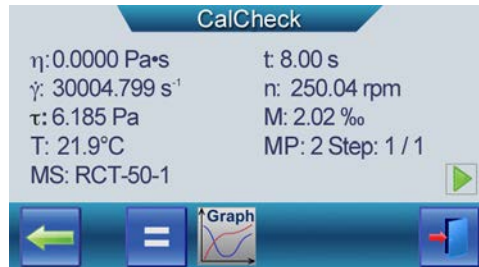

Figure II-75

To transfer files from Data folder to a USB flash drive:

- 1) From the Explorer main screen (shown in the Figure II-76), Double tap the Data folder.
- 2) Select the file or files to transfer. Select a file by tapping it once. When a file is selected it will be highlighted in green. The maximum number of files that can be exported simultaneously is six. The files must be selected from the same screen.
- 3) When any files are selected, a data transfer icon appears in the lower left corner of the screen, as shown in Figure II-76. Press the data transfer icon to automatically transfer the file or files to the flash drive. Refer to Section II.4.14 to configure the file format used upon export.

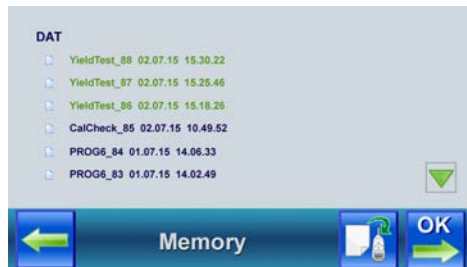

Figure II-76

II.4 Settings

From the home screen, press the “Settings” icon to manage settings for the RST Rheometer:



Figure II-77

Note that the settings menu has a second page (Figure II-78):



Figure II-78

II.4.1 Time

Time allows the user to set the current date and time. The date and time display formats can be changed using the blue boxes, shown in Figure II-79.

Additionally, the green arrow label “Cal” can be used to calibrate the clock if it runs fast or slow.



Figure II-79

II.4.2 Counter

Counter reports the number of tests that have been run by your RST Rheometer.



Figure II-80

II.4.3 Zeroing

Zeroing measures the instrument's bearing friction in the drive shaft. The instrument uses this information to adjust test measurements by subtracting the bearing friction from the measured torque.

Zeroing should be performed upon first use of the instrument. It is also recommended after instrument transport and periodically as part of a good instrument care practice.

To zero the instrument, press the icon for the appropriate operating range. The Zeroing process will run automatically. When the process is finished, press OK to save the zeroing data.



Figure II-81

High Range zeroing is for speeds above 1 rpm. High Range zeroing is appropriate for most viscosity tests.

Low Range zeroing is for low speeds in the 0.1 to 1 rpm range. Very Low Range zeroing is for speeds as low as 0.01 rpm. These lower zeroing ranges are appropriate for Creep, Creep Relaxation, SST, and Yield tests, which tend to operate at low speeds.

The time required to do all zeroing procedures is about 2 hours and 13 minutes. Figure II-81 shows time required for each procedure.

II.4.4 Barcode

The barcode feature can be used for spindle recognition. If the barcode recognizes a measuring system that is not already stored, the Add icon shown in Figure II-82 will appear. To add the measuring system, press the Add icon and follow the instructions provided in Section II.3.2 on measuring systems.



Figure II-82

The barcode scanner can also be turned off from this screen using the icon on the lower left side of the screen. This feature is helpful when using the older generation measuring systems (i.e. V3, RC3, RP3, and CC3), which do not have barcodes on the spindles.

II.4.5 Memory

Memory displays the instrument's total memory and how much free memory is remaining. Total memory and free memory are also displayed for a USB flash drive, if connected to the instrument (Figure II-83).



Figure II-83

From the memory screen, the user also has access to Explorer via the icon on the right side of the screen. Explorer allows the user to view stored data files and is explained in detail in Section II.3.5.

II.4.6 Self Test

Self-Test performs a voltage test on the instrument, followed by a test of the optical encoder. A self-test is run automatically upon instrument start up, but can be repeated using this feature.

II.4.7 Temperature

Figure II-84 depicts the temperature screen. Temperature displays the temperature detected from an attached Pt100 sensor in both degrees Celsius and degrees Fahrenheit. Below the Pt100 temperature is the Set Temperature, which is the temperature that the instrument has been instructed to achieve at startup of the instrument or between tests if Hold Temp option is not checked.



Figure II-84

Active temperature control can be adjusted by pressing the Edit icon to the right of the Set Temperature. As shown in Figure II-85, use up and down green arrows to turn active temperature control on or off. Tap on up green arrow to turn control on, down green arrow to turn off and then press OK. If active temperature control is set to be on, the screen depicted in Figure II-84 will allow the user to adjust the Set Temperature. Press OK to save.

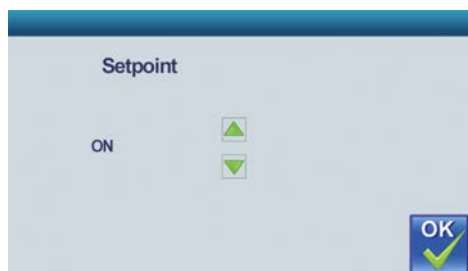

Figure II-85

Additionally, from the Temperature screen, the user can adjust the temperature accuracy settings by pressing the temperature settings icon on the bottom right of the screen. The following screen shown in Figure II-86 will allow the user to change Delta T and Time. Delta T is the acceptable accuracy range in temperature units specified in Edit Units (see Section II.3.1). A Set Temperature of 25°C and a Delta T of 0.5°C would mean that a Pt100 detected temperature is acceptable in the range of 24.5°C to 25.5°C. Time refers to the time in seconds the instrument is instructed to wait after achieving the Set Temperature before proceeding with a test.



Figure II-86

II.4.8 USB Port

USB Port provides information on the use of the port. When a USB flash drive is connected to the instrument, it is identified under USB Host. When a printer is connected to the instrument, it is identified under USB Device.



Figure II-87

The RST Rheometer will only recognize USB flash drives formatted in FAT32.

II.4.9 Language

In order to change the language used by the touch screen display system, from the “Settings” menu, use the green down arrow to continue to the second screen of Settings options. Press the “Language” icon. See Figure II-88 through II-90. Press the relevant icon to set the touch system display language.



Figure II-88



Figure II-89



Figure II-90

User screens for the RST Rheometer are available in the following languages:

- German
- English
- Chinese
- Polish

In future versions, the following languages will be implemented:

- Japanese
- French
- Portuguese
- Russian
- Spanish

II.4.10 RS232 Port

This menu item allows the user to configure the RS232 port.



Figure II-91

II.4.11 Service

This menu item is relevant only for service work and may be requested by our service technician.

II.4.12 About

This screen identifies firmware and hardware information for your RST Rheometer.



Figure II-92

The first line on this screen shown in Figure II-92 displays the instrument model. On the right side, the serial (SN) and part (PN) numbers are also listed.

Also shown is the following:

- D: Main processor information (with the date of its last update in parentheses)
- T: Touch screen display information
- B: Barcode reader (s/n)
- C: USB information
- A: Temperature control information
- S: Sensoric board
- Z: Z-drive for CPS instruments with automatic gap setting
- P: Printed circuit board information

II.4.13 Display

The display menu is shown in Figure II-93. Use the radio buttons to control the brightness and delay time required before the screen saver begins.



Figure II-93

To recalibrate the touch screen, press the “Touch Calibration” button and follow the instructions on the screen

II.4.14 Export Options



Figure II-94

Choices for file format when exporting data include .csv, .bin, and .txt.

Numerical data can be delineated by either a decimal point or comma.

Separator designation can either be a tab or a semicolon.

II.5 Run Program 1 to 11

To run a stored program, press the icon for the program to be run. The program will prompt for the substance name first. Then spindle recognition will be performed followed by gap setting procedure if using the RST-CPS model. The test will execute automatically.

III Measuring Systems and Sample Preparation

The general procedure for measurements with an RST Rheometer is as follows:

- Connect the AC adapter.
- Connect a printer or PC, if required.
- Assemble any accessories to be used (e.g. FTKY3 water jacket).
- Connect a Pt100 temperature sensor, if required.
- Remove any attached spindle.
- Turn the power button ON and wait until the main menu is shown by the touch screen display system.
- Turn on computer system, if required.
- Prepare the sample.
- Attach the measuring system.
- Start a measuring program.
- Begin fluid circulation if temperature control is being used. Wait until the substance to be measured has reached the desired temperature.
- Start measurement.
- After completion of measurement, turn off temperature control and wait until your sample has cooled down to a safe temperature.
- Remove and clean the measuring system.

This section provides instructions on how to prepare measuring systems and sample materials for measurement with the RST Rheometer.

III.1 Preparing Samples for use with the RST-CC and RST-SST Rheometers

The following measuring systems are used with RST-CC and RST-SST Rheometers:

- Standard coaxial geometry measuring systems:
 - sample cup (MBT-40...MBT-8, MBT-DG, and special order MBT-45 and MBT-48)
 - sample cup bottom
 - cylinder spindle (CCT-40...CCT-8, CCT-DG, and special order CCT-45 and CCT-48)
 - threaded joint for securing the sample cup to the instrument
- Coaxial geometry measuring systems for measurement with FTKY3 temperature control:
 - sample cup (MBT-40F...MBT-8F, MBT-DGF, and special order MBT-45F and MBT-48F)
 - cylinder spindle (CCT-40...CCT-8, CCT-DG, and special order CCT-45 and CCT-48)
 - threaded joint for securing the sample cup in FTKY3
 - FTKY3 temperature control device
- Disposable measuring systems for measurement with FTKY3 temperature control:
 - disposable aluminum sample cup (CC-3-40-DC...CC-3-8-DC)
 - measuring chamber for sample cup (CC-3-40-R...CC-3-8-R)
 - sample cup ejector (CC-3-40-P...CC-3-8-P)
 - cylinder spindle (CCT-40...CCT-8 or disposable spindle CCT-25D)
- Vane measuring systems for measurement of soft solids directly in the sample container:
 - vane spindle (VT-10-5...VT-80-70)
- Vane measuring systems for measurement of soft solids in a measuring chamber:
 - sample cup (MBT-40 and MBT-25)
 - vane spindle (VT-40-20MB)

To carry out measurements, select a measuring system suited for the desired measuring range and rheological requirements.

III.1.1 Measurement Directly in the Sample Container

III.1.1.1 Coaxial Cylinder Measuring Systems

To prepare a coaxial cylinder measuring system for testing directly in the sample container, as shown in Figure III-1:

- 1.) Open the spindle coupling by lifting the black coupling sleeve up. The inner ring of the coupling will be visible under the coupling sleeve. Figure III-3 shows an open spindle coupling.
- 2.) Insert the spindle of choice into the coupling. Be careful to insert the spindle shaft into the coupling without bumping against it. Close the coupling by sliding the coupling sleeve down. Figure III-4 shows a closed spindle coupling.
- 3.) Remove the sample cup screw cap. It will not be used.
- 4.) On the instrument, remove the threaded ring for securing the sample cup. Place the sample cup through the threaded ring so that the sample cup flange sits on the threaded ring.
- 5.) Reattach the threaded ring to the instrument to secure the sample cup in place. Be careful not to bump the spindle when sliding the sample cup and threaded ring over the spindle.
- 6.) RST-SST only: Ensure that the work plate is assembled. The instrument has two seat heights for the work plate. Use the seat height most appropriate for the sample container height. Instructions on adjusting the work plate are supplied in Section I.3.5.2.
- 7.) RST-SST only: Secure the sample container in place on the work plate.
- 8.) Immerse the sample cup in the sample material as far as the ring mark or conical swelling (shown in the Figure III-2). Do so by adjusting the rheometer head height. Ensure that no sample material penetrates into the spindle coupling or measuring drive.
- 9.) Insert a Pt100 sensor into the sample material to record the sample temperature during measurement. Do not immerse the Pt100 temperature sensor into the sample deeper than 2/3 of the length of the metal rod. The Pt100 cable must remain outside the sample.
- 10.) Connect the Pt100 sensor to the instrument using the port on the back of the instrument. It is necessary to restart the instrument in order for it to recognize the sensor as connected.
- 11.) Proceed with measurement.

To disassemble a coaxial cylinder measuring system used for testing directly in the sample container:

- 1.) Gently raise the rheometer head out of the sample material. Move slowly to minimize strain on the rheometer.
- 2.) Hold the sample cup in place and unscrew the threaded ring securing the sample cup. Remove the sample cup and threaded ring. Be careful not to bump the spindle when removing the sample cup and threaded ring.
- 3.) Open the spindle coupling and remove the spindle carefully.
- 4.) Clean the sample cup and spindle. Do not use any objects in cleaning that might scratch the sample cup or spindle.
- 5.) Store the spindle on a soft surface or in its original container.
- 6.) Remove and clean the Pt100 sensor.



Figure III-1

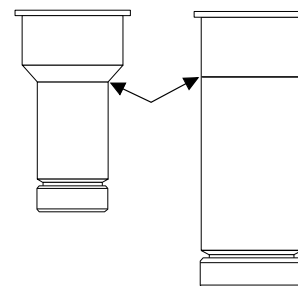

Figure III-2



Figure III-3



Figure III-4

III.1.1.2 Vane Measuring Systems

To prepare a vane measuring system for soft-solid testing directly in a sample container, as shown in Figure III-5:

- 1.) Open the spindle coupling by lifting the black coupling sleeve up. The inner ring of the coupling will be visible under the coupling sleeve. Figure III-3 shows an open spindle coupling.
- 2.) Insert the spindle of choice into the coupling. Be careful to insert the spindle shaft into the coupling without bumping against it. Close the coupling by sliding the coupling sleeve down. Figure III-4 shows a closed spindle coupling.
- 3.) RST-SST only: Ensure that the work plate is assembled. The instrument has two seat heights for the work plate. Use the seat height most appropriate for the sample container height. Instructions on adjusting the work plate are supplied in Section I.3.5.2.
- 4.) RST-SST only: Secure the sample container in place on the work plate.
- 5.) Lower the rheometer head such that the vane spindle is lowered into the sample material. It is important to minimize disturbance of the sample material when lowering the spindle into the sample. Lower the rheometer head until the immersion mark on the spindle is level with the sample material surface. Ensure that no sample material penetrates into the spindle coupling or measuring drive.
- 6.) Insert a Pt100 sensor into the sample material to record the sample temperature during measurement. Do not immerse the Pt100 temperature sensor into the sample deeper than 2/3 of the length of the metal rod. The Pt100 cable must remain outside the sample.
- 7.) Connect the Pt100 sensor to the instrument using the port on the back of the instrument. It is necessary to restart the instrument in order for it to recognize the sensor as connected.



Figure III-5

To disassemble a vane measuring system used for testing directly in the sample container:

- 1.) Gently raise the rheometer head out of the sample material. Move slowly to minimize strain on the rheometer.
- 2.) Open the spindle coupling and remove the spindle carefully.
- 3.) Clean the spindle. Do not use any objects in cleaning that might scratch the spindle.
- 4.) Store the spindle on a soft surface or in its original container.

III.1.2 Measurement with the Sample in the Measuring System

To prepare a sample for testing with a cylinder measuring system, as shown in Figure III-6:

- 1.) Determine the sample volume appropriate for the measuring system to be used. (Refer to Appendix E: “Data Sheets for Standard Measuring Systems”.) Fill the sample cup with sample material accordingly. Avoid trapping air bubbles in the sample material, as they may result in irreproducible or false data.
- 2.) Carefully insert the spindle into the sample cup. Avoid introducing air bubbles to the sample.
- 3.) Ensure that the spindle coupling is open. If it is closed, open the spindle coupling by lifting the black coupling sleeve up. The inner ring of the coupling will be visible under the coupling sleeve. Figure III-3 shows an open spindle coupling.
- 4.) Remove the threaded ring for securing the sample cup from the instrument. Place the sample cup through the threaded ring so that the sample cup flange sits on the threaded ring.



Figure III-6

- 5.) Reattach the threaded ring to the instrument to secure the sample cup in place. Be careful to align the spindle shaft with the coupling.
- 6.) Insert the spindle into the coupling. Be careful to insert the spindle shaft into the coupling without bumping against it. Close the coupling by sliding the coupling sleeve down. Figure III-4 shows a closed spindle coupling.
- 7.) A circulation bath can be used for temperature control. Set the fluid circulation bath to the intended sample temperature. Do not operate beyond the temperature range of -10°C to +90°C without additionally using the KE cooling device to protect the rheometer head from damaging temperatures. Never operate beyond the temperature range of -20°C to +180°C.
- 8.) Immerse the sample cup into the circulation bath as far as the ring mark or conical swelling (shown in the Figure III-2 above). Do so by adjusting the rheometer head height. Ensure that no circulating fluid will splash into the sample cup. Ensure that no sample material or circulating fluid penetrates into the spindle coupling or measuring drive. Wait for the sample to come to temperature.
- 9.) Insert a Pt100 sensor into the circulating bath to record the sample temperature during measurement. Do not immerse the Pt100 temperature sensor deeper than 2/3 of the length of the metal rod. The Pt100 cable must remain outside the circulating bath.
- 10.) Connect the Pt100 sensor to the instrument using the port on the back of the instrument. It is necessary to restart the instrument in order for it to recognize the sensor as connected.
- 11.) Proceed with measurement.



To disassemble a cylinder measuring system:

- 1.) Take note of the operating temperature. Allow the measuring system to cool to a safe temperature before disassembling.
- 2.) Release the spindle by opening the spindle coupling.
- 3.) Hold the sample cup in place and unscrew the threaded ring securing the sample cup. Remove the sample cup and threaded ring.
- 4.) Remove the spindle from the sample cup.
- 5.) Dispose of the used sample material properly.
- 6.) Clean the spindle and sample cup. To clean the sample cup, unscrew the sample cup bottom and clean each piece of the sample cup separately. Do not use any object in cleaning that might scratch the spindle or sample cup pieces.
- 7.) Store the spindle on a soft surface or in its original container.
- 8.) Remove the Pt100 sensor from the circulating bath and clean it. Do not use solvent on any piece of the sensor beyond the metal rod.



III.1.3 Measurement with the FTKY3 Temperature Control Device

III.1.3.1 Standard Measuring Systems

To prepare a sample for testing in a cylinder measuring system with FTKY3 temperature control:

- 1.) If the KE cooling device will be used, assemble it first according to the instructions in Section I.3.6.1. The KE cooling device is required for operating temperatures beyond the range of -10°C to +90°C in order to protect the rheometer head from damaging temperatures.
- 2.) Assemble the FTKY3 temperature control device as instructed in Section I.3.6.2.
- 3.) Set the fluid circulation bath to the intended sample temperature. Do not operate beyond temperatures of 90°C without using the KE cooling device. Do not operate beyond the temperature range of -20°C to +180°C even with the KE cooling device.



Figure III-7

- 4.) Determine the sample volume appropriate for the measuring system to be used. (Refer to Appendix E: "Data Sheets for Standard Measuring Systems".) Fill the sample cup with sample material accordingly. Avoid trapping air bubbles in the sample material, as they may result in irreproducible or false data. Be sure to use a sample cup designed for use with the FTKY3.
- 5.) Carefully insert the spindle into the sample cup. Avoid introducing air bubbles to the sample. Figure III-7 shows how the measuring system should look so far.
- 6.) Ensure that the spindle coupling is open. If it is closed, open the spindle coupling by lifting the black coupling sleeve up. The inner ring of the coupling will be visible under the coupling sleeve. Figure III-3 shows an open spindle coupling.
- 7.) Remove the threaded ring for securing the sample cup from the FTKY3 device.
- 8.) Insert the sample cup into the water jacket from below and reattach the threaded ring to secure the sample cup in place. Be careful to align the spindle shaft with the coupling. Figure III-4 shows a closed spindle coupling.
- 9.) Reattach the threaded ring to the instrument to secure the sample cup in place.
- 10.) Insert the spindle into the coupling. Be careful to insert the spindle shaft into the coupling without bumping against it. Close the coupling by sliding the coupling sleeve down.
- 11.) If using the KE cooling device, begin cool water circulation through the device.
- 12.) Begin circulation to the FTKY3 water jacket. Wait for the sample to come to temperature.
- 13.) Proceed with measurement.

To disassemble a cylinder measuring system used with the FTKY3 temperature control device:

- 1.) Take note of the operating temperature. Allow the measuring system to cool to a safe temperature before disassembling.
- 2.) Release the spindle by opening the spindle coupling.
- 3.) Unscrew the threaded ring securing the sample cup. Remove the sample cup and threaded ring.
- 4.) Remove the spindle from the sample cup.
- 5.) Dispose of the used sample material properly.
- 6.) Clean the spindle and sample cup. To clean the sample cup, unscrew the sample cup bottom and clean each piece of the sample cup separately. Do not use any object in cleaning that might scratch the spindle or sample cup pieces.
- 7.) Store the spindle on a soft surface or in its original container.



Danger!

III.1.3.2 Disposable Measuring Systems

To prepare a sample for testing in a disposable measuring system with FTKY3 temperature control:

- 1.) If the KE cooling device will be used, assemble it first according to the instructions in Section I.3.6.1. The KE cooling device is required for operating temperatures beyond the range of -10°C to +90°C in order to protect the rheometer head from damaging temperatures.
- 2.) Assemble the FTKY3 temperature control device as instructed in Section I.3.6.2.
- 3.) Set the fluid circulation bath to the intended sample temperature. Do not operate at over 90°C without additionally using the KE cooling device. Do not operate beyond the temperature range of -20°C to +180°C even with the KE cooling device.
- 4.) Insert a disposable aluminum cup into its measuring chamber as far as the widening of the aluminum cup. Due to the widening in its upper part, the sample cup is held and clamped tightly.



Caution!



Figure III-8

- | | | | |
|---|--------------------|---|--------------------------------|
| 1 | Measuring chamber | 3 | Disposable aluminum sample cup |
| 2 | Sample cup ejector | | |

- 5.) Determine the sample volume appropriate for the measuring system to be used. (Refer to Appendix E: "Data Sheets for Standard Measuring Systems".) Fill the sample cup with sample material accordingly. Avoid trapping air bubbles in the sample material, as they may result in irreproducible or false data.
- 6.) Carefully insert the spindle into the sample cup. Avoid introducing air bubbles to the sample.
- 7.) Ensure that the spindle coupling is open. If it is closed, open the spindle coupling by lifting the black coupling sleeve up. The inner ring of the coupling will be visible under the coupling sleeve. Figure III-3 shows an open spindle coupling.
- 8.) Remove the threaded ring for securing the measuring system from the FTKY3 device.
- 9.) Insert the measuring system into the water jacket from below and reattach the threaded ring to secure the measuring system in place. Be careful to align the spindle shaft with the coupling. Figure III-4 shows a closed spindle coupling.
- 10.) Reattach the threaded ring to the instrument to secure the measuring system in place.
- 11.) Insert the spindle into the coupling. Be careful to insert the spindle shaft into the coupling without bumping against it. Close the coupling by sliding the coupling sleeve down.
- 12.) If using the KE cooling device, begin cool water circulation through the device.
- 13.) Begin circulation to the FTKY3 water jacket. Wait for the sample to come to temperature.
- 14.) Proceed with measurement.

To disassemble a disposable measuring system used with the FTKY3 temperature control device:

- 1.) Take note of the operating temperature. Allow the measuring system to cool to a safe temperature before disassembling.
- 2.) Release the spindle by opening the spindle coupling.
- 3.) Unscrew the threaded ring securing the measuring system. Remove the measuring system and threaded ring.
- 4.) Remove the spindle from the measuring system.
- 5.) Clean the spindle carefully. Do not use any object in cleaning that might scratch the spindle.
- 6.) Store the spindle on a soft surface or in its original container.
- 7.) Dispose of the used sample material properly.
- 8.) Eject the disposable sample cup. Use the ejector to push the disposable cup out from the measuring chamber and into the receptacle for its disposal. When ejecting the disposable cup, point the measuring chamber and ejector nowhere other than the receptacle for the sample cup's disposal, as the sample cup may eject with some velocity.
- 9.) Clean the measuring chamber as necessary.



III.1.4 Measurement Using the ME3 Cone/Plate and Plate/Plate Adapter

To prepare a sample for testing with the ME3 measuring device, as shown in Figure III-9:

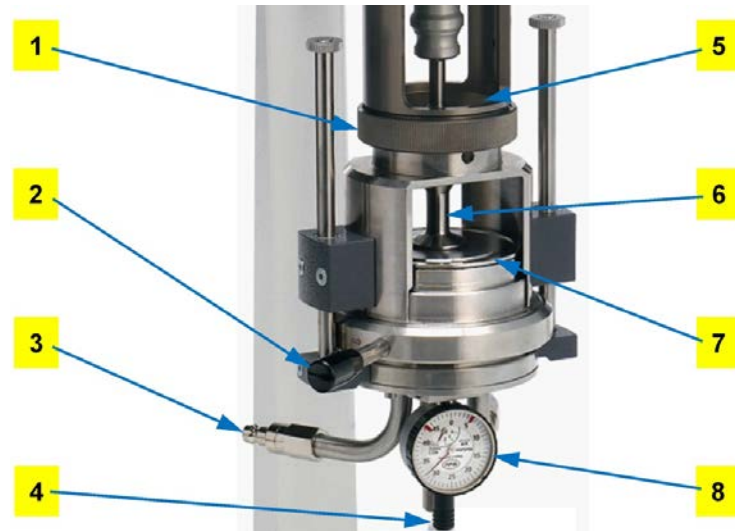

Figure III-9

1	Threaded ring for mounting flange	5	Guide pin
2	Quarter-turn fastener	6	Spindle
3	Hose connectors for circulating fluid	7	Measuring table
4	Adjusting screw	8	Gauge for gap setting

- 1.) If the KE cooling device will be used, assemble it first according to the instructions in Section I.3.6.1. The KE cooling device is required for operating temperatures beyond the range of -10°C to $+90^{\circ}\text{C}$ in order to protect the rheometer head from damaging temperatures.
- 2.) Assemble the ME3 cone-plate adapter as instructed in Section I.3.6.3.
- 3.) Loosen the hexagon socket screw on the spindle and adjust the spindle to its shortest length. Fix the spindle at its minimum height by tightening the hexagon socket screw.
- 4.) Ensure that the spindle coupling is open. If it is closed, open the spindle coupling by lifting the black coupling sleeve up. The inner ring of the coupling will be visible under the coupling sleeve. Figure III-3 shows an open spindle coupling.
- 5.) Loosen the quarter-turn fastener (“loose” position) and pull the measuring table downwards to make room to insert the measuring system spindle. Hold the measuring device with one hand by the lower part when loosening the quarter-turn fastener, or else the measuring table will fall down.
- 6.) Insert the spindle into the coupling. Be careful to insert the spindle shaft into the coupling without bumping against it. Close the coupling by sliding the coupling sleeve down. Figure III-9 shows a closed spindle coupling.
- 7.) Turn the adjusting screw at the measuring table into the lower position. Then move the measuring table back up and secure with the quarter-turn fastener (“fixed” position).
- 8.) Reduce the distance between spindle and measuring table to about 1 mm by turning the adjusting screw up, moving to a suitable “0” position at the scale of the adjusting screw.
- 9.) Then set the measuring gauge also to the “0” position. Unlock the spindle shaft with a hexagon screw, and allow the spindle to move down so that it makes contact with the measuring table. Tighten the hexagon screw to secure the spindle shaft at this height.
- 10.) Lower the measuring table by 0.5mm using the adjusting screw (one turn of the screw) and then move it up again to position “5” (50 μm). Adjust the height to match the exact cone truncation height listed on the spindle data sheet (about 50 μm). If using a plate spindle, adjust the height to the appropriate gap height for the sample material instead.
- 11.) Open the quarter-turn fastener to move the measuring table down. Hold the measuring device with one hand by the lower part when loosening the quarter-turn fastener, or else the measuring

table will fall down. Apply the substance to be measured to the plate. Appropriate sample volumes are listed on the spindle data sheet. Avoid air bubbles in the sample material, as they may result in irreproducible or false data.

- 12.) Lift the measuring table back into working position and close the quarter-turn fastener. The sample should fill the entire gap between the spindle and the measuring plate. Use a spatula to remove any sample material outside the circumference of the spindle, as any overfill will result in false data.
- 13.) If using temperature control, set the fluid circulation bath to the intended sample temperature. Do not operate at temperatures over 90°C without using the KE cooling device. Do not operate beyond the temperature range of -20°C to +180°C even with the KE cooling device.
- 14.) If using the KE cooling device, begin cool water circulation through the device.
- 15.) If using temperature control, begin circulation to the ME3 device. Wait for the sample to come to temperature.
- 16.) Proceed with measurement.



When testing multiple samples, note that removing and attaching the spindle can change the gap by 1-2 μm . If you only lower and lift the bottom plate and clean the spindle in place without removing, the gap is set like before. Minimal changes under 1 micron may occur. Therefore, the recommended approach is to lower the bottom plate after the measurement, clean cone and plate, put new sample on the plate and lift up the plate until the stop is reached.

To disassemble a measuring system from the ME3 measuring device:

- 1.) Take note of the operating temperature. Allow the measuring system to cool to a safe temperature before disassembling.
- 2.) Release the spindle by opening the spindle coupling.
- 3.) Open the quarter-turn fastener and pull down the measuring table.
- 4.) Slide the spindle off the measuring table.
- 5.) Wipe sample material from the spindle and measuring table. Clean the spindle and measuring table. Do not use any object in cleaning that might scratch the spindle or measuring table.
- 6.) Store the spindle on a soft surface or in its original container.



III.2 Preparing Samples for use with the RST-CPS Rheometer

The cone/plate and plate/plate measuring systems consist of the fixed bottom plate on the instrument and the upper measuring cone or plate element that is height-adjustable to set the required gap.

To carry out measurements, please select a measuring system suited for the desired measuring range and your rheological requirements.

III.2.1.1 Manual Gap Instruments

To prepare a sample with a cone or plate measuring system using a manual gap instrument:

- 1.) Ensure that the spindle coupling is open. If it is closed, open the spindle coupling by lifting the black coupling sleeve up. The inner ring of the coupling will be visible under the coupling sleeve. Figure III-3 shows an open spindle coupling.
- 2.) Make sure the rheometer head is in the raised position.
- 3.) Insert the spindle of choice into the coupling. Be careful to insert the spindle shaft into the coupling without bumping against it. Close the coupling by sliding the coupling sleeve down. Figure III-4 shows a closed spindle coupling.
- 4.) When prompted by the touch screen display, choose to adjust the gap. Follow the gap setting instructions detailed in Appendix B.

- 5.) With the rheometer head in the raised position, load the sample onto the center of the bottom plate. The appropriate sample volume is indicated on the spindle data sheet. Avoid air bubbles in the sample material, as they may result in irreproducible or false data. Use the Stop button to abort the program.

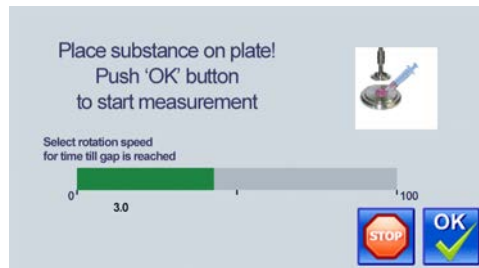

Figure III-10

- 6.) On the display screen shown in Figure III-10, the user has the option to select a rotational speed between 0 and 100 rpm for the spindle during the lowering of the rheometer head. This rotation helps to evenly distribute the sample for the following situations: if the sample is not perfectly centered on the plate, to remove air bubbles, or to spread high viscosity materials. If performing tests to analyze thixotropic behavior, select a rotational speed of 0 RPM to minimize shearing before test measurements begin. When finished, press OK.
- 7.) Gently lower the rheometer head to the bottom position. Lower the head slowly to give the measuring system time to evenly distribute the test sample. The sample material should now occupy the entire space between the measuring system and the bottom plate, with minimal overflow. If there is unfilled space between the measurement system and the bottom plate, the gap may have been set improperly or an incorrect sample volume may have been loaded onto the bottom plate. This will cause error in the viscosity reading.

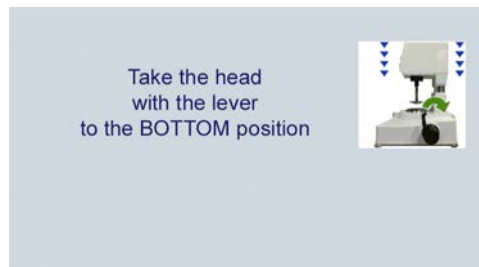

Figure III-11

- 8.) If there is any sample material outside the circumference of the spindle, press the Stop button and carefully remove the excess with a spatula. Sample material outside the circumference of the spindle may result in irreproducible or false data.

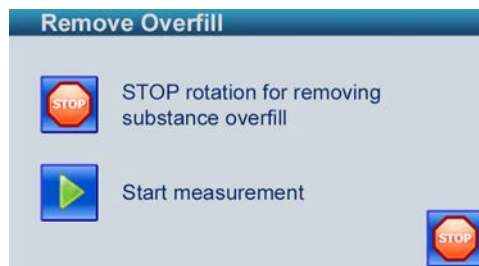

Figure III-12

- 9.) When finished, press the green arrow to start measurement.

To disassemble a cone or plate measuring system:

- 1.) Take note of the operating temperature. Allow the measuring system to cool to a safe temperature before disassembling.
- 2.) Release the spindle by opening the spindle coupling.
- 3.) Use the lever to move the rheometer head to its raised position
- 4.) Slide the spindle off the measuring table.
- 5.) Wipe sample material from the spindle and measuring table. Clean the spindle and measuring table. Do not use any object in cleaning that might scratch the spindle or measuring table.
- 6.) Store the spindle on a soft surface or in its original container.



III.2.1.2 Automatic Gap Instruments

To prepare a sample with a cone or plate measuring system using an automatic gap instrument:

- 1.) Ensure that the spindle coupling is open. If it is closed, open the spindle coupling by lifting the black coupling sleeve up. The inner ring of the coupling will be visible under the coupling sleeve. Figure III-3 shows an open spindle coupling.
- 2.) When the coupling is opened, the instrument's Z-drive will automatically move the rheometer head to the raised position.
- 3.) Insert the spindle of choice into the coupling. Be careful to insert the spindle shaft into the coupling without bumping against it. Close the coupling by sliding the coupling sleeve down. Figure III-4 shows a closed spindle coupling.
- 4.) When prompted by the touch screen display, choose to adjust the gap. Follow the gap setting instructions detailed in Appendix B.
- 5.) Load the sample onto the center of the bottom plate. The appropriate sample volume is indicated on the spindle data sheet. Avoid air bubbles in the sample material, as they may result in irreproducible or false data.

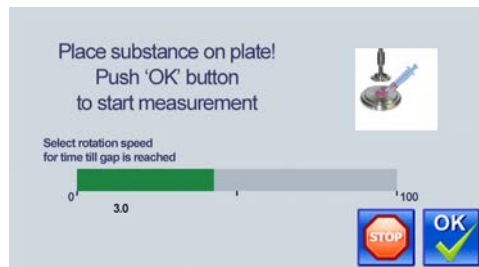

Figure III-13

- 6.) On the display screen shown in Figure III-13 above, select a rotational speed to apply to the spindle during the lowering of the rheometer head. This rotation helps to evenly distribute the sample for the following situations: if the sample is not perfectly centered on the plate; to remove air bubbles, or to spread high viscosity materials. If performing tests to analyze thixotropic behavior, select a rotational speed of 0 RPM to minimize shearing before test measurements begin. When finished, press OK.
- 7.) The instrument's Z-drive will automatically lower the rheometer head to the bottom position shown in Figure III-14. The sample material should now occupy the entire space between the measuring system and the bottom plate, with minimal overflow. If there is unfilled space between the measurement system and the bottom plate, the gap may have been set improperly or an incorrect sample volume may have been loaded onto the bottom plate. This will cause error in viscosity reading.

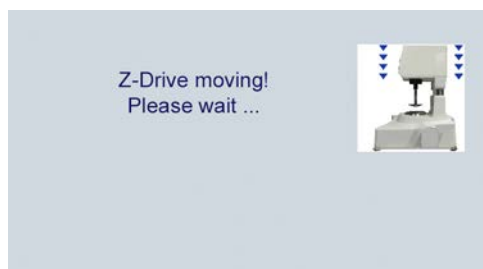

Figure III-14

- 8.) If there is any sample material outside the circumference of the spindle, press the Stop button or the display screen (Figure III-15) before carefully removing the excess with a spatula. Sample material outside the circumference of the spindle will result in irreproducible or false data.

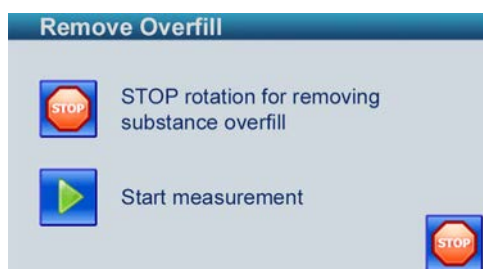

Figure III-15

- 9.) When finished, press the green arrow to start measurement.

To disassemble a cone or plate measuring system:

- 1.) Take note of the operating temperature. Allow the measuring system to cool to a safe temperature before disassembling.
- 2.) Release the spindle by opening the spindle coupling.
- 3.) The instrument's Z-drive will automatically move the rheometer head to its raised position.
- 4.) Slide the spindle off the measuring table.
- 5.) Wipe sample material from the spindle and measuring table. Clean the spindle and measuring table. Do not use any object in cleaning that might scratch the spindle or measuring table.
- 6.) Store the spindle on a soft surface or in its original container.



III.2.1.3 CPS Instrument with Peltier Temperature Control

Shut Down procedure during power off automatically brings bottom plate temperature to 30°C. This is the best practice for preserving long life of Peltier element.

IV Trouble Shooting

The following situations may occur when operating the instrument. Use the corrective action described in this section. If you need further assistance to fix the problem, contact AMETEK Brookfield or your local authorized dealer.

COMMUNICATION WITH RHEO 3000 SOFTWARE

The RST Rheometer must be powered on and the home screen is displayed. The Icon at the top of the screen displays a green USB comm symbol with a yellow "R" in the middle. Select "Device Watch" in Rheo3000 and click the "Check Communication" button. Rheo3000 will automatically recognize the RST Rheometer model and serial number.

DISPLAY SCREEN FREEZES

Press the power on/off button on the back of the instrument and hold down for 3 to 5 seconds. The instrument will shut down. Press the power on/off button to turn the instrument on. Power up will take place and the home screen will be displayed.

TOUCHSCREEN RECALIBRATION

Normally the touchscreen doesn't need a recalibration. But if required, follow these steps:

1. Switch on the RST Rheometer while touching one finger on the touchscreen.
2. Observe a white font and black background: "touch adjustment". Release your finger for less than a second and tap again quickly for at least 1 second on the touchscreen.
3. Follow the instructions on the touchscreen for purposes of recalibration.

NAVIGATING "RUN SINGLE"

Forward and backward arrows do not go to the correct screen. Check your firmware version in Settings/About. Upgrade your instrument to the current version for RST firmware.

CREATING LOG FILE FOR SERVICE

- Insert a memory stick into the USB port on the rear of the instrument.
- The RST must be ON and is in the main screen.
- Click on "Edit", click on "Explorer".
- Double click on "SD-CARD 0".
- Double click on "LOG".
- Scroll down to the current year by clicking the arrow keys and double click on the current year.
- Scroll down to the current month by clicking the arrow keys and double click on the current month.
- You will see the path in the first line, e.g. "SDC:/LOG/2016/6".
- Click on the file "LOG0.LOG". A copy icon at the bottom appears.
- Click once on this copy icon. The required file is now on the USB-Stick.
- Go to the main screen by clicking on the house icon.
- Now disconnect your USB-Stick. You will find your log-file on the USB-Stick under the folder "RST..." with the serial number of the instrument suffix.
- Email the file to AMETEK Brookfield or your local authorized dealer.

Appendix A: Technical Data

RST Rheometer	
Viscosity range ¹⁾	0.1*10 ⁻³ to 5.4*10 ⁶ Pa*s
Torque range line-powered	up to 100 mNm
Torque resolution	0.15 µNm
Speed range	0.01 to 1,300 min ⁻¹
Angular resolution	1.2 µrad
Temperature range ²⁾	-20° to +180°C -4° to +356°F
Range of shear rate ¹⁾	0.013 to 7.8*10 ³ s ⁻¹
Range of shear stress ¹⁾	0.27 to 69*10 ³ Pa
Weight (included AC adapter)	11 kg 24 lbs.
Dimensions (Width x Height x Depth)	350 mm x 580 mm x 320 mm 14 in x 23 in x 13 in
Ambience conditions	
Temperature in operation	+10° to +40°C +50° to +104°F
Relative humidity (not condensing) in operation	20% to 80%

¹⁾ The range depends on the used measuring system and the sample. Contact your Brookfield dealer for further information.

²⁾ The range depends on the temperature control. Higher temperatures are available. Contact your Brookfield dealer for further information.

AC Adapter	
Dimensions	155 mm x 60 mm x 38 mm 6 in x 2.4 in x 1.5 in
Weight	0.5 kg 1 lb
Power supply	
operating voltage	80 to 264 VAC
output voltage	24 V DC
output amperage	3.54 A
power output	85 W
Frequency	47 to 63 Hz

Appendix B: Gap Setting Procedure for the RST-CPS Rheometer

This procedure is for the RST-CPS Rheometer. Procedures for both the manual gap and automatic gap models are included. If there is a black micrometer ring on the RST-CPS Rheometer, it is a manual gap setting instrument. Otherwise it is an instrument with automatic gap control.

“The gap” refers to the gap between a cone or plate spindle and the measuring bottom plate. For cone spindles, the gap height is the height of the tip of the cone, which has been truncated so as to prevent contact between the cone spindle and the measuring bottom plate. This value is indicated on the cone spindle data sheet as the cone truncation value. The gap height for plate spindles is usually determined by the largest particle size in the material. Best practice is to use a gap height 5 to 10 times greater than the largest particle diameter. (For example, if the largest particle in the substance is 0.010 mm, then the gap height should be 0.050 to 0.10 mm.) If the material does not have large particles, but is highly viscous, experiment with various gap heights to determine what will give the most repeatable viscosity measurements.

Any time a spindle is changed, the gap needs to be adjusted. If a user is running multiple back-to-back tests with the same spindle, only removing the spindle between tests to clean it, then the gap only needs to be adjusted before the first test, and the gap setting procedure can be skipped for the proceeding tests.

Before any test is performed, in standalone mode or under PC control, the touch screen display system will present the user with the prompt shown in Figure B-1. To begin the gap setting procedure, choose **Yes**.

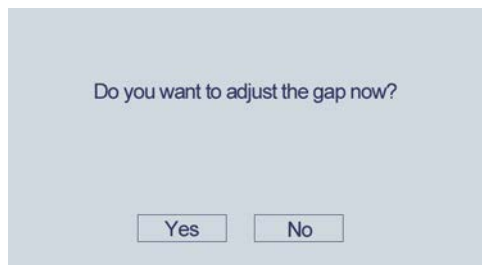

Figure B-1

B.1 Procedure for Manual Gap Adjustment Instruments

- 1.) Ensure that the spindle and measuring bottom plate are clean. There should be no sample material on the plate. The rheometer head should be in the raised position.
- 2.) Loosen the hexagon screw on the shaft of the spindle, as instructed by the display screen shown in Figure B-2. Pull down on the cone spindle to make sure that the shaft is fully extended. When finished, press OK.

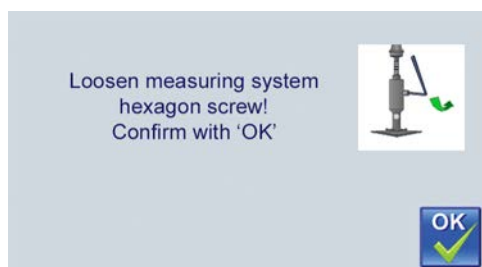

Figure B-2

- 3.) Move the black micrometer dial at the rear of the base to 0 as instructed by the display screen shown in Figure B-3. The display screen may specify that the user should turn the micrometer in

a certain direction. If this happens, turn the micrometer as instructed until the display updates to an instruction to set the micrometer to 0. Press OK.



Figure B-3

- 4.) Lower the rheometer head to the bottom position using the lever shown in Figure B-4. The measuring system should make contact with the bottom plate.

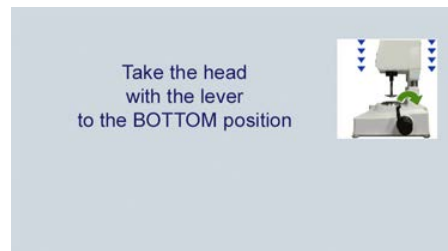

Figure B-4

- 5.) If operating at a temperature greater than +40°C, the touch screen will instruct the user to wait for the spindle to temper for 10 minutes before continuing the gap setting process. Allowing the spindle to temper accounts for any thermal elongation of the spindle which could otherwise result in faulty measurement or damage to the measurement system. If operating at very high or very low temperatures, the user should wear heat safety gloves for the remainder of the gap setting process.
- 6.) Tighten the measuring system screw as shown in Figure B-5. It may be helpful to hold the measuring system at the joint between its two shafts and apply gentle downward pressure while tightening the screw. This will ensure that the measuring system does not lift from the bottom plate during tightening. Press OK.

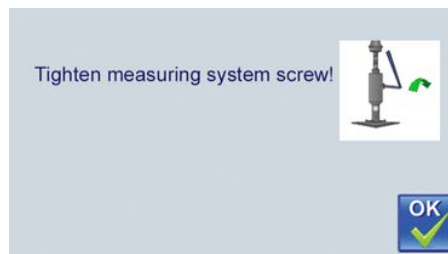

Figure B-5

- 7.) Raise the rheometer head to its top position using the lever as shown in Figure B-6.

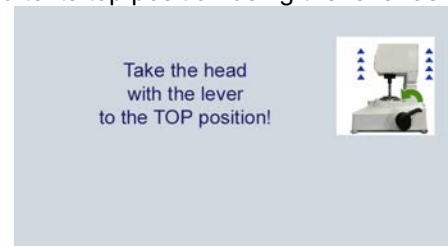

Figure B-6

- 8.) Use the micrometer to set the gap to the height instructed by the display screen as shown in Figure B-7. Each minor division line on the micrometer dial equals 0.005 mm (5 microns). When finished, press OK.



Figure B-7

- 9.) The next screen instructs the user to place the sample material on the plate. Follow the instructions provided in Section III.2.

B.2 Procedure for Automatic Gap Control Instruments

- 1.) Ensure that the spindle and measuring bottom plate are clean. There should be no sample material on the plate. The rheometer head should be in the raised position. It is also important that the correct measuring system is selected at the beginning of the program because the automatic gap control uses the measuring system information to adjust to the correct gap height. Measuring systems with the same basic geometry may still have unique cone truncation heights.
- 2.) Loosen the hexagon screw on the shaft of the spindle, as instructed by the display screen shown in Figure B-8. Pull down on the cone spindle to make sure that the shaft is fully extended. When finished, press OK.

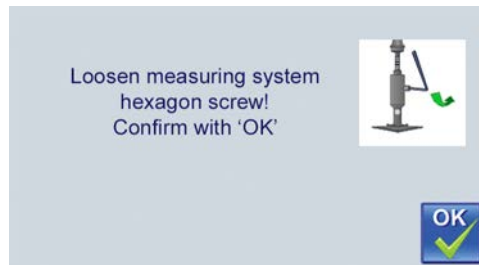

Figure B-8

- 3.) The rheometer head will then automatically move downward to the hit point. The hit point is the point at which the measuring system makes contact with the bottom measuring plate.



Figure B-9

- 4.) If operating at a temperature greater than 40°C, the touch screen will instruct the user to wait for the spindle to temper for 10 minutes before continuing the gap setting process. Allowing the spindle to temper accounts for any thermal elongation of the spindle which could otherwise result in faulty measurement or damage to the measurement system. If operating at very high or very low temperatures, the user should wear heat safe gloves for the remainder of the gap setting process.



- 5.) Tighten the measuring system screw as instructed by the touch screen display shown in Figure B-10. It may be helpful to hold the measuring system at the joint between its two shafts and apply gentle downward pressure while tightening the screw. This will ensure that the measuring system does not lift from the bottom plate during tightening. Press OK.

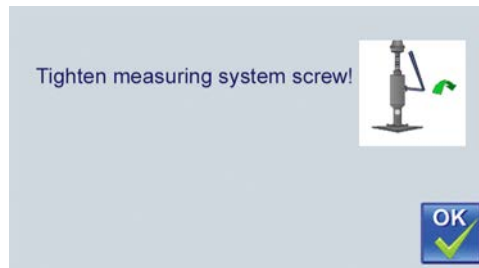

Figure B-10

- 6.) The rheometer head will automatically move to the raised position, and the gap will automatically be adjusted shown in Figure B-11.

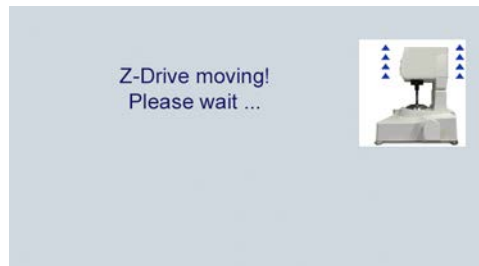

Figure B-11

- 7.) The next screen instructs the user to place the sample material on the plate. Follow the instructions provided in Section III.2.

B.3 Procedure for Using Plate Spindle

Choices for plate spindle include:
RPT-25: plate with 25mm diameter
RPT-50: plate with 50mm diameter
RPT-75: plate with 75 mm diameter

It is possible to request plates with alternative diameters by contacting your authorized AMETEK Brookfield dealer for quote and delivery.

RST-CPS with Peltier plate for temperature control will work only with RPT-25 and RPT-50 plate spindles.

The gap can be set from 10 μ m to 5mm. Resolution is 1 μ m. Before setting the gap, temper the plate spindle first by bringing it into contact with the Peltier plate and allowing it to equilibrate to your test temperature.

Shear rate is calculated for each plate spindle at the outer radius.

B.4 Leveling the Instrument

It may be desirable to level the instrument prior to running a calibration check or testing your sample material. This is advisable in particular for low viscosity fluids. Use the bubble level mounted on the front of the instrument for this purpose.

Appendix C: Calibration Check

The calibration check procedure is performed in order to verify that your RST Rheometer is making correct viscosity measurements. It can be done in standalone mode or under control of Rheo-3000 software. Perform the calibration check with the spindle that is most frequently used with your instrument. You do not need to perform a calibration check with additional spindles unless there is a concern that a specific spindle is not measuring properly.

The calibration check can be performed at regularly scheduled time intervals determined by you (before each shift, weekly, monthly, etc.) or at any time when there is concern that the instrument is not measuring correctly.

Before performing the calibration check, it is advisable to perform the Zeroing procedure. This feature is accessed in the Settings menu in standalone mode. At a minimum run both the High Range and Low Range Zeroing procedures. The time required to do both is slightly more than a half hour.

Use the appropriate viscosity standard for the spindle that you want to test. Consult the following table, which shows the fluid that is recommended for each type of spindle and the required sample volume to perform the calibration check:

Cone Spindles	Fluid	Sample Volume
RCT-25-1	B41000	0.1mL
RCT-25-2	B73000	0.2mL
RCT-50-1	B10200	1.0mL
RCT-50-2	B21000	2.0mL
RCT-75-1	B4900	2.5mL
RCT-75-2	B10200	5.0mL

Coaxial Spindles	Fluid	Sample Volume
CCT-8	B360000	<i>Do Not Perform Calibration Checks with this Spindle!</i>
CCT-14	B73000	<i>Do Not Perform Calibration Checks with this Spindle!</i>
CCT-25	B21000	16.8mL
CCT-40	B2000	68.5mL
CCT-DG	B200	15.7mL

If you have an RS-SST Rheometer and use vane spindles, Brookfield recommends that you perform a calibration check with either the CCT-40 or CCT-25 Coaxial Spindles and the associated chamber, which will also attach to your instrument.

You will also need a circulating temperature bath to condition the viscosity standard to a set temperature, normally 25°C. All Brookfield viscosity standards are calibrated at 25°C. Additional temperature calibrations are available upon request when the fluid is ordered from AMETEK Brookfield or an authorized dealer.

If you have an RST-CPS Rheometer with Peltier Temperature control, you do not require the circulating temperature bath. Temperature control capability is built into the instrument.

Prepare the proper sample volume for the test and condition to the defined temperature within +/- 0.1°C. Mineral oil is highly temperature sensitive, so it is important to do this correctly.

The calibration check procedure is performed at 3 separate controlled torque values: 125, 250, and 375 per mille. The spindle rotates for a minimum of 15 seconds at each torque value. Observe that the viscosity reading remains relatively constant vs. time. The viscosity reading at each torque value is recorded after 15 seconds or a longer time interval of your choosing. The three viscosity readings must each be within +/- 3% for RST-CC and within +/-5% for RST-CPS of the actual fluid value for the calibration check to pass.

If the calibration check fails, review each step to make sure that everything was done correctly in accordance with the test procedure. Repeat the test procedure if necessary. Areas for potential error are not having the proper sample volume and not conditioning the sample to the correct temperature. It is also possible that shear heating may occur at the highest torque 375 per mille for certain spindle geometries; if the viscosity value starts to drop, it may be due to shear heating; record the viscosity reading 15 seconds after the test starts at this torque to minimize potential error. If the instrument fails when you repeat the calibration check, contact AMETEK Brookfield or your local authorized dealer.

Appendix D: Symbols for Test Parameters and Units of Measurement

Parameter	Symbol	Unit
Speed	n	[min ⁻¹]
Torque	M	[1000 % _o = 100 mNm]
Temperature	T	[°C, °F]
Time	t	[s]
Shear Rate	$\dot{\gamma}$	[s ⁻¹]
Shear Stress	τ	[Pa]
Viscosity	η	[Pa•s, mPa•s, cP, P]

Appendix E: Data Sheets for Standard Measuring Systems

Table of Coaxial Cylinder Measuring Systems according to DIN 53018 / 53019 / ISO 3219
(consisting of measuring spindle and sample cup)

Three sample cup models are available for use with the RST-CC and RST-SST Rheometers; the following example is for CCT-40 spindle:

- MBT-40 for direct immersion
- MBT-40F for use with FTKY3 water jacket
- CC3-40-R for disposable chambers

Measuring system	CCT-40	CCT-25	CCT-14	CCT-8	CCT-45	CCT-48
Shear rate range [s^{-1}]	0.0215...2,790	0.013...1,670	0.013...1,680	0.013...1,672	0.013...1,6752	0.013...6,576
Shear stress range [Pa]	0.89...594	3.43...2,280	19.5...13,000	104...69,600	0.019...192	0.019...192
Viscosity range [$Pa \cdot s$] ¹⁾	0.0003... 27,600	0.002...177,0 00	0.012... 1,000,000	0.065... 5,410,000	0.0013...230	0.0003...230
Filling quantity [mL]	68.5	16.8	3.4	1	130	117
Shear rate factor $K\dot{\gamma}$ [s^{-1}/RPM]	2.1480	1.2894	1.2969	1.2865	1.2946	5.0585
Shear stress factor $\tau_{\%}$ [Pa]	0.2969	1.1419	6.5052	34.8426	0.1930	0.1925
Measuring bob radius R_i [mm]	20.0	12.5	7	4	22.5	23.9
Sample cup radius R_a [mm]	21.0	13.56	7.59	4.34	24.4	24.4
Shaft radius R_s [mm]	3.5	3.5	2.1	1.2	3.5	3.5
Angle of measuring bob cone α [°]	120	120	120	120	120	120
Distance from lower edge of measuring bob to sample cup bottom L' [mm]	20.5	15.5	13	12	35	35
Length of shaft immersed L'' [mm]	20	12.5	7	4	22.5	23.9
Length of measuring bob L [mm]	60	37.5	21	12	68.5	68.5
Radius ratio δ	1.050	1.0847	1.0847	1.0847	1.0844	1.0209
Coefficient of resistance c_L	1.1	1.1	1.1	1.1	1.09	1.03

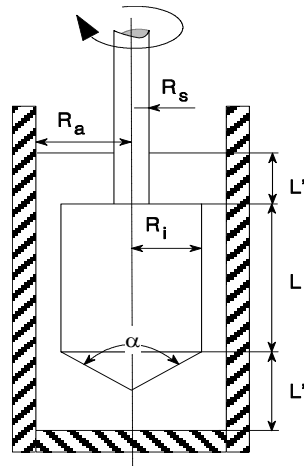

Measuring geometry according to DIN 53019

Table of double gap cylinder measuring system according to DIN 54453 (consisting of measuring spindle and sample cup)

Measuring system	CCT-DG
Shear rate range [s^{-1}]	0.043 ... 5,640
Shear stress range [Pa]	0.265 ... 177
Viscosity range [$Pa \cdot s$] ¹⁾	0.00005 ... 4,070
Filling quantity [mL]	15.7
Shear rate factor $K\dot{\gamma}$ [s^{-1}/RPM]	4.3443
Shear stress factor $\tau_{\%}$ [Pa]	0.0884
Inside radius of measuring bob R_2 [mm]	19.72
Outside radius of measuring bob R_3 [mm]	20.5
Inside radius of sample cup R_1 [mm]	19.25
Outside radius of sample cup R_4 [mm]	21.0
Measuring length L [mm]	111
Radius ratio δ	1.0244
Coefficient of resistance c_L	1

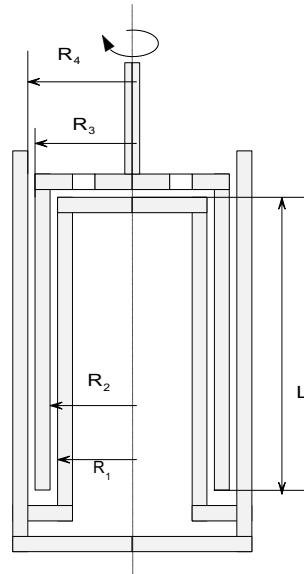

Measuring geometry according to DIN 54453

Table of cone/plate measuring systems

Measuring System	RCT-25-1	RCT-25-2	RCT-50-1	RCT-50-2	RCT-75-1	RCT-75-2
Shear rate range [s ⁻¹]	0.06 ... 7,800	0.03 ... 3,900	0.06 ... 7,800	0.03 ... 3,900	0.06 ... 7,800	0.03 ... 3,900
Shear stress range [Pa]	36.7 ... 24,400	36.7 ... 24,400	4.58 ... 3,050	4.58 ... 3,050	1.36 ... 905	1.36 ... 905
Viscosity range [Pa*s] ¹⁾	0.005 ... 407,000	0.01 ... 814,000	0.0006 ... 50,900	0.0012 ... 101,000	0.0002 ... 15,000	0.0004 ... 30,000
Filling quantity [mL]	0.1	0.2	1	2	2.5	5
Shear rate factor $K\dot{\gamma}$ [s ⁻¹ /RPM]	6.00	3.00	6.00	3.00	6.00	3.00
Shear stress factor $\tau_{\%}$ [Pa]	12.223	12.223	1.5279	1.5279	0.4527	0.4527
Measuring cone radius R [mm]	12.5	12.5	25	25	37.5	37.5
Angle of measuring cone α [°]	1	2	1	2	1	2
Cone truncation [μm]	50	50	50	50	50	50

Table of plate/plate measuring systems

(consisting of measuring spindle and RST-CPS measuring bottom plate or ME3 measuring bottom plate)

The following values pertain to a plate distance of 1 mm. For all other plate distances you can easily calculate $K\dot{\gamma}$ using the formula:

- $K\dot{\gamma} = (2 * \pi / 60) * (R / H)$ R = radius, H = plate distance

Measuring System	RPT-25	RPT-50	RPT-75
Shear rate range [s ⁻¹]	0.013 ... 1,700	0.027 ... 3,400	0.04 5,100
Shear stress range [Pa]	49 ... 32,600	6.2 ... 4,070	1.8 ... 1,200
Viscosity range [Pa*s] ¹⁾	0.03 ... 2,490,000	0.002 ... 155,000	0,0004 ... 30,700
Filling quantity [mL]	0.5	2.0	4.5
Shear rate factor $K\dot{\gamma}$ [s ⁻¹ /RPM]	1.309	2.618	3.927
Shear stress factor $\tau_{\%}$ [Pa]	16.297	2.037	0.604
Radius of measuring plate R [mm]	12.5	25.0	37.5

Table of Vane Spindles for use with the RST-SST Soft Solids Tester

Vane	Height [mm]	Diameter [mm]	Shear Stress [Pa]
VT-10-5	10	5	330 ... 210,000
VT-20-10	20	10	41 ... 27,000
VT-20-20	20	20	9 ... 5,900
VT-30-15	30	15	12 ... 8,000
VT-40-20	40	20	5.2 ... 3,400
VT-40-40	40	40	1.2 ... 740
VT-50-25	50	25	2.7 ... 1,700
VT-60-8	60	8	24 ... 15,000
VT-60-15	60	15	7 ... 4,300
VT-60-30	60	30	1.6 ... 1,000
VT-80-40	80	40	0.7 ... 420
VT-80-70	80	70	0.2 ... 120

Stress Constant: τ_{prom}

All standard vanes supplied for the Soft Solids Tester have a height (H) to diameter (D) ratio of 2:1. A stress constant is required for each vane to convert torque in Newton meters to shear stress in Pascals. This constant is calculated as follows:

$$\tau_{prom} = \frac{10^{-4}}{\pi D^3} \left(\frac{H}{D} + \frac{1}{3} \right)^{-1}$$

The constants for the standard vanes are as follows:

Vane	Diameter [mm]	Height [mm]	τ_{prom} .
VT-10-5	5	10	109.206
VT-20-10	10	20	13.651
VT-20-20	20	20	2.986
VT-30-15	15	30	4.045
VT-40-20	20	40	1.706
VT-40-40	40	40	0.373
VT-50-25	25	50	0.874
VT-60-8	8	60	7.941
VT-60-15	15	60	2.178
VT-60-30	30	60	0.506
VT-80-40	40	80	0.213
VT-80-70	70	80	0.063

Example:

$$\text{VT-20-10: } \tau_{prom} = \frac{10^{-4}}{\pi D^3} \left(\frac{H}{D} + \frac{1}{3} \right)^{-1} = \frac{0.001}{\pi \cdot 0.01^3} \left(\frac{0.02}{0.01} + \frac{1}{3} \right)^{-1} = 13.651$$

These are pre-loaded in the Rheo 3000 software. If you do not have these vanes available in Block Editor or on your instrument, then please load them using Meas-Editor for software driven setups, or see Section VI.6.4: Utilities Measuring Systems for stand-alone setups.

Strain/Rate Constant: K-Gamma

The constant K-Gamma converts the rotational rate or position into shear rate/strain values. Its value is dependent upon the ration of container-to-vane diameter. The vanes pre-loaded into the Rheo 3000 software (e.g. V40-20-3 to 1) assume a ratio of 3:1. If you use vane/container combinations that don't match this, you will need to set up a new measuring system in Meas-Editor or see Section VI.6.4: Utilities Measuring Systems. You can calculate out the required value using this equation:

$$K - \text{gamma} = \frac{0.2094}{1 - b^2}$$

where b is the ratio of vane to container diameters. Alternatively, select an appropriate value from the following table:

Container to Vane Diameter Ratio	Shear Rate Constant K_γ
1,5 : 1	0,3763
2 : 1	0,2792
3 : 1	0,2355
4 : 1	0,2234
5 : 1	0,2181
∞ : 1	0,2094

It is also possible to use a vane spindle with the MBT measuring chamber. This combination can be used to measure slurries (fluids with suspended particles). The standard vane spindle (e.g. VT-40-20) will appear with a modified part number (e.g. VT-40-20MB) in our Brookfield price lists. The shaft on the vane spindle has been shortened to allow the spindle to fit in the MB chamber. For example, VT-40-20MB spindle can be used with the MBT-25 chambers. Contact AMETEK Brookfield or your local authorized dealer for more information.

Appendix F: Measuring in Brabender Units (BU)

RST-SST Rheometers have firmware that will recognize spindle geometry RST-90Y for testing according to ASTM C474. RST-90Y is used with RST-SST Rheometers having serial numbers beginning with 70 or with 304.

The RST-90Y spindle has three parts, illustrated in the figure below:

- Spindle Adapter (PN: RSS-86)
- BU Spindle Type A (PN: RSS-88)
- Thumb Screw (PN: C1K-34Y)

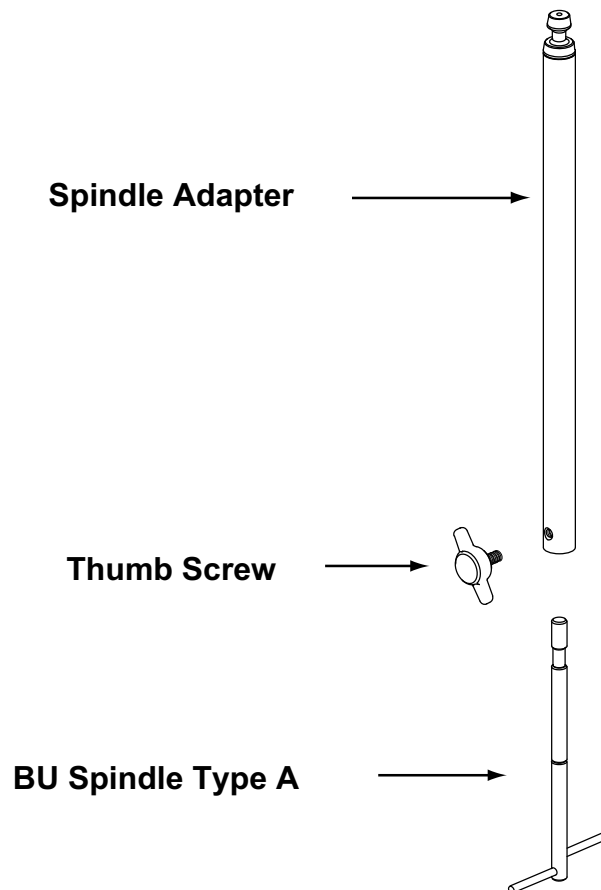

A typical test runs for 60 seconds at 78 RPM. The Brabender Unit (BU) value at the end of the time interval is recorded.

The measurement unit is the “BU”, which replaces the shear stress value on the rheometer display. BU is calculated by multiplying the measured FSR torque value by the BU Factor. The BU Factor is set to a value of 4.0 for the RST-SST Rheometer, but may be adjusted if necessary in the Edit feature for Measuring Systems.

Calibration check of the RST Rheometer, when using a Brabender spindle, is done with the special kit RSS-109, which includes CCT-40 spindle, MBT-40 chamber and 1000 cP viscosity standard fluid calibrated at five different temperatures.

Appendix G: Instrument Dimensions

RST-CC:

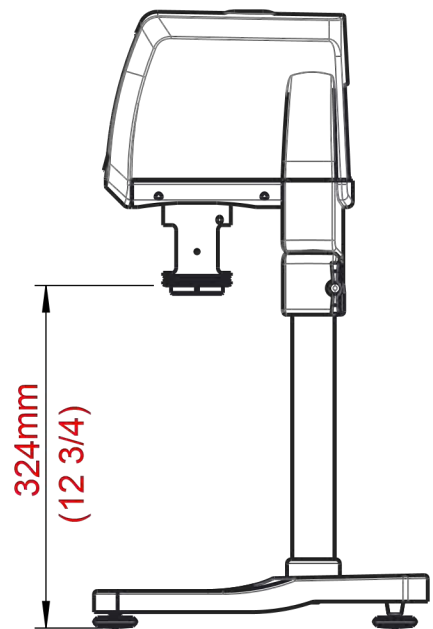
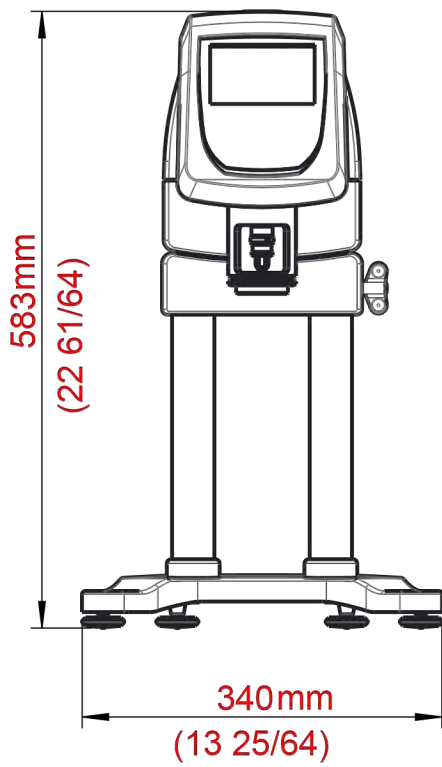
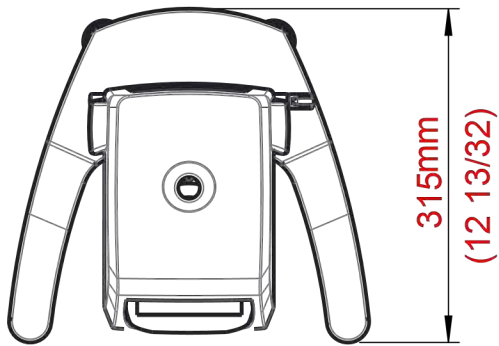

RST-SST:

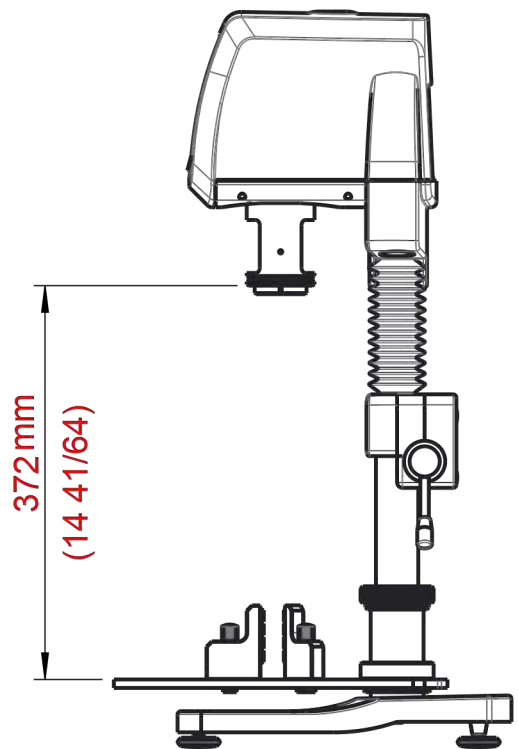
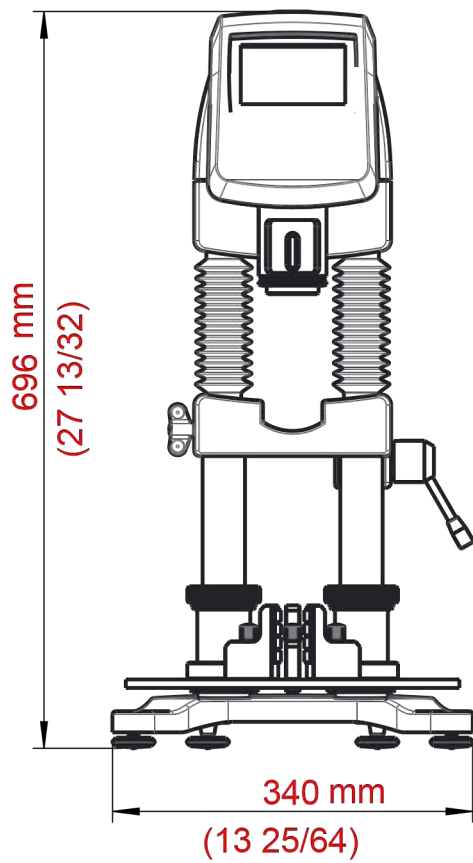
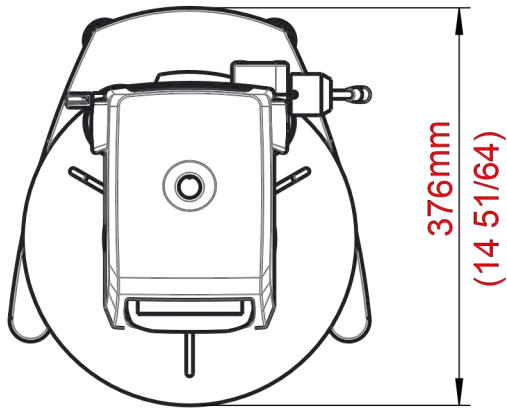

RST-CPS-F:

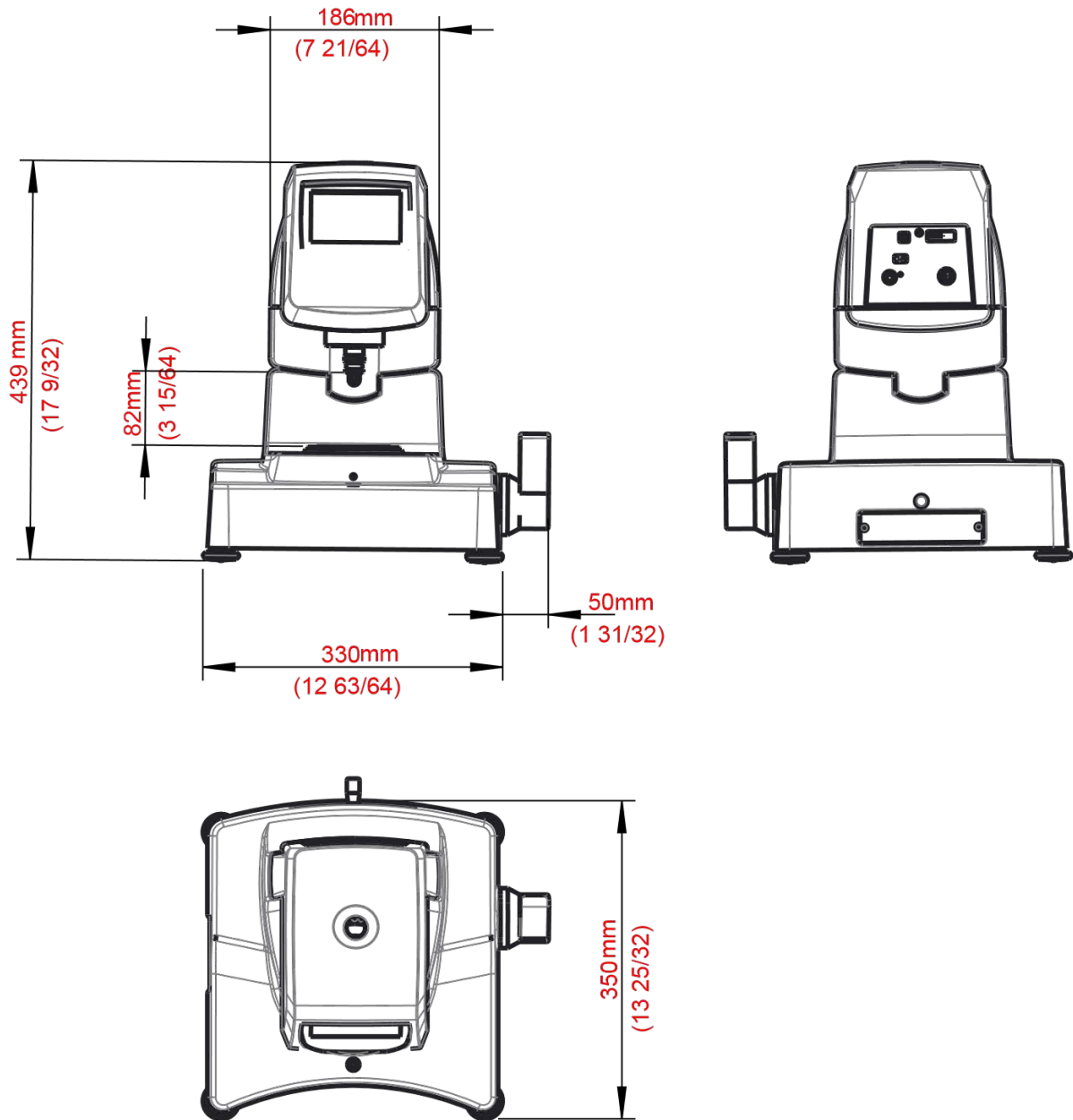

RST-CPS-PA /-PO, RST-CPS-EH:

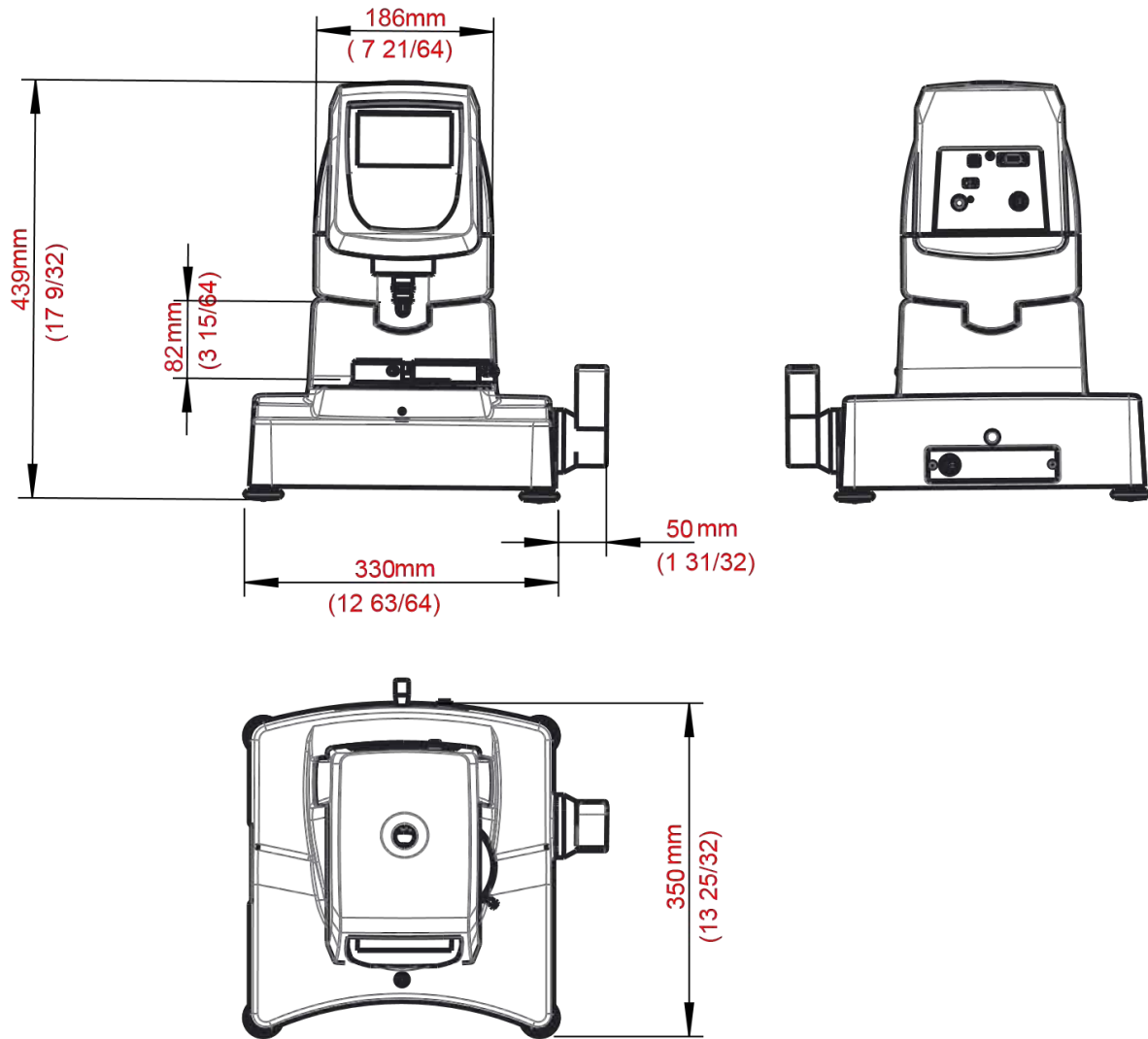

Appendix H: Online Help and Additional Resources

www.brookfieldengineering.com**

The Brookfield website is a good resource for additional information and self-help whenever you need it. Our website offers a selection of “how-to” videos, application notes, conversion tables, instructional manuals, material safety data sheets, calibration templates and other technical resources.

<http://www.youtube.com/user/BrookfieldEng>

Brookfield has its own YouTube channel. Videos posted to our website can be found here as well as other “home-made” videos made by our own technical sales group.

www.ViscosityJournal.com

Brookfield has a satellite website that should be your first stop in viscosity research. This site serves as a library of interviews with experts in the viscosity field as well as Brookfield technical articles and conversion charts. Registration is required, so that you can be notified of upcoming interviews and events, however, this information will not be shared with other vendors, institutions, etc.

Article Reprints

- **Available in Print Only**

Brookfield has an extensive library of published articles relating to viscosity, texture and powder testing. Due to copyright restrictions, these articles cannot be emailed. Please request your hardcopy of articles by calling our customer service department directly or by emailing: marketing@brookfieldengineering.com.

- **Available Online**

Brookfield has a growing number of published articles that can be downloaded directly from the Brookfield website. These articles can be found on our main site by following this path: [http://www.brookfieldengineering.com/support/documentation/article reprints](http://www.brookfieldengineering.com/support/documentation/article%20reprints).

More Solutions to Sticky Problems

Learn more about viscosity and rheology with our most popular publication. This informative booklet will provide you with measurement techniques, advice and much more. It's a must-have for any Brookfield Viscometer or Rheometer operator. More Solutions is available in print and also as a downloadable PDF on the Brookfield website by following this path:

<http://www.brookfieldengineering.com/support/documentation>.

Training/Courses

Whether it is instrument-specific courses, training to help you better prepare for auditing concerns, or just a better understanding of your methods, who better to learn from than the worldwide leaders of viscosity measuring equipment? Visit our Services section on our website to learn more about training.

** Downloads will require you to register your name, company and email address. We respect your privacy and will not share this information outside of Brookfield.

Appendix I: Warranty Repair and Service

Warranty

Brookfield Viscometers are guaranteed for one year from date of purchase against defects in materials and workmanship. They are certified against primary viscosity standards traceable to the National Institute of Standards and Technology (NIST). The Viscometer must be returned to **AMETEK Brookfield** or your local authorized dealer from whom it was purchased for a warranty evaluation. Transportation is at the purchaser's expense. The Viscometer should be shipped in its carrying case together with all spindles originally provided with the instrument. If returning to Brookfield, please contact us for a return authorization number prior to shipping. Failure to do so will result in a longer repair time.

For a copy of the Repair Return Form, go to the Brookfield website,
www.brookfieldengineering.com

For repair or service in the **United States** return to:

AMETEK Brookfield
11 Commerce Boulevard
Middleboro, MA 02346 U.S.A.
Telephone: (508) 946-6200 FAX: (508) 946-6262
www.brookfieldengineering.com

For repair or service outside the United States, consult AMETEK Brookfield or the authorized dealer from whom you purchased the instrument.

For repair or service in the **United Kingdom** return to:

AMETEK (GB) Limited
Brookfield Technical Centre
Stadium Way
Harlow, Essex CM19 5GX, England
Telephone: (44) 1279/451774 FAX: (44) 1279/451775
www.brookfield.co.uk

For repair or service in **Germany** return to:

AMETEK GmbH
Hauptstrasse 18
D-73547 Lorch, Germany
Telephone: (49) 7172/927100 FAX: (49) 7172/927105
www.brookfield-gmbh.de

For repair or service in **China** return to:

AMETEK Commercial Enterprise (Shanghai) Co., Ltd
Suite 905, South Tower, Xindacheng Plaza
193 Guangzhou Da Dao Bei, Yuexiu District
Guangzhou, 510075 P. R. China
Telephone: (86) 20/3760-0548 FAX: (86) 20/3760-0548
www.brookfield.com.cn

On-site service at your facility is also available from Brookfield. Please contact our Service Department in the United States, United Kingdom, Germany or China for details.