

# SevenDirect™ SD50

pH/Ion Meter

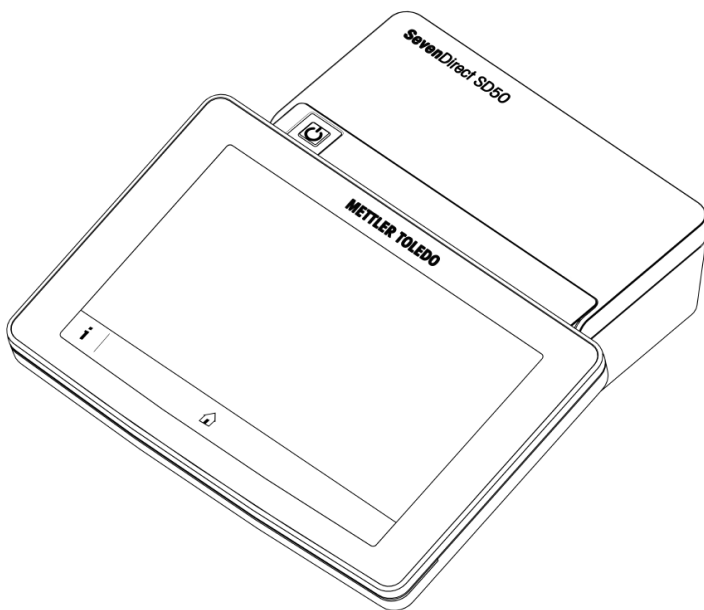

METTLER TOLEDO



# Table of Contents

<b>1</b>	<b>Introduction</b>	<b>3</b>
<b>2</b>	<b>Safety Information</b>	<b>4</b>
2.1	Definitions of signal words and warning symbols .....	4
2.2	Product specific safety notes .....	4
<b>3</b>	<b>Design and Function</b>	<b>6</b>
3.1	Overview .....	6
3.2	Rear panel connections .....	6
3.3	User interface .....	7
3.3.1	Main sections at a glance .....	7
3.3.2	Home screen .....	7
3.3.2.1	Display representation .....	8
3.3.3	How to operate the touch screen .....	10
3.3.3.1	Selecting or activating an item .....	10
3.3.3.2	Scrolling up and down .....	10
3.3.3.3	Accessing specific menus .....	11
3.3.3.4	Secondary functions for list items .....	11
3.3.3.5	Entering characters and numbers .....	11
3.3.3.6	Entering numbers and unit .....	11
3.3.3.7	Changing date and time .....	12
<b>4</b>	<b>Putting into Operation</b>	<b>13</b>
4.1	Scope of delivery .....	13
4.2	Mounting EasyPlace™ .....	13
4.3	Installing power supply .....	13
4.4	Switching the instrument on and off .....	14
4.5	First Startup Wizard .....	14
4.6	Connecting sensors .....	15
<b>5</b>	<b>Starting Analysis</b>	<b>16</b>
5.1	Selecting a method .....	16
5.2	Selecting a sensor .....	16
5.3	Starting a calibration .....	16
5.4	Starting a verification .....	17
5.5	Starting a measurement .....	17
5.6	Interrupting analysis .....	18
5.7	Endpoint criterion .....	18
5.8	Measurement status .....	18
<b>6</b>	<b>Menu</b>	<b>19</b>
6.1	Logging in and out .....	19
6.2	Global settings .....	20
6.2.1	General .....	20
6.2.2	Peripherals .....	20
6.2.3	Analysis settings .....	21
6.2.4	User settings .....	22
6.3	User management .....	23
6.3.1	Creating a new user .....	23
6.3.2	Deleting an user .....	24
6.3.3	Changing the password .....	24
6.3.4	Editing User Group .....	25
6.4	Sensors .....	26
6.4.1	Creating a sensor .....	26

6.4.2	Deleting a sensor .....	26
6.4.3	Editing a sensor .....	27
6.4.4	pH Sensor Parameters .....	27
6.4.5	Redox Sensor Parameters .....	28
6.4.6	Ion Sensor Parameters .....	29
6.5	Buffers & Standards .....	30
6.5.1	Creating customized buffer group / standard list .....	31
6.6	Maintenance & Service .....	32
6.6.1	Instrument .....	32
6.6.2	Service .....	32
6.6.3	Peripherals status .....	33
6.6.4	Import / Export .....	33
6.6.5	Update .....	33
6.6.6	Firmware history .....	34
6.6.7	Factory reset .....	34
<b>7</b>	<b>Methods</b> .....	<b>35</b>
7.1	Adding a new method .....	35
7.2	Cloning a method .....	36
7.3	Deleting a method .....	36
7.4	Editing a method .....	37
7.5	Printing a method .....	38
7.6	pH method parameters .....	38
7.7	Redox method parameters .....	42
7.8	Ion method parameters .....	45
7.9	Stability criteria .....	48
<b>8</b>	<b>Result</b> .....	<b>49</b>
8.1	Results fly-in .....	52
8.2	Result details .....	53
8.2.1	Result Reason & Result Status .....	53
<b>9</b>	<b>Maintenance and Care</b> .....	<b>55</b>
9.1	Cleaning the Instrument .....	55
9.2	Maintenance of electrodes .....	55
9.3	Transporting the instrument .....	56
9.4	Disposal .....	56
<b>10</b>	<b>Sensors, Solutions and Accessories</b> .....	<b>57</b>
<b>11</b>	<b>Technical Data</b> .....	<b>59</b>
<b>12</b>	<b>Appendix</b> .....	<b>61</b>
12.1	Predefined buffers .....	61
12.2	Predefined standards .....	65

# 1 Introduction

The SevenDirect is an intuitive, easy-to-operate benchtop meter for parameters such as pH, redox potential, conductivity and ion concentrations (depending on instrument version). It is designed for robustness in typical laboratory settings and supports the recording and transfer of important measurement data.

## Conventions and symbols



Refers to an external document.

## Note

For useful information about the product.

## Elements of instructions

Instructions always contain action steps and can contain prerequisites, intermediate results and results. If an instruction contains more than one action step, the action steps are numbered.

- Prerequisites that must be fulfilled before the individual action steps can be executed.
- 1 Action step 1
  - ➔ Intermediate result
- 2 Action step 2
  - ➔ Result

## 2 Safety Information

Two documents named "User Manual" and "Reference Manual" are available for this instrument.

- The User Manual is printed and delivered with the instrument.
- The electronic Reference Manual contains a full description of the instrument and its use.
- Keep both documents for future reference.
- Include both documents if you transfer the instrument to other parties.

Only use the instrument according to the User Manual and the Reference Manual. If you do not use the instrument according to these documents or if the instrument is modified, the safety of the instrument may be impaired and Mettler-Toledo GmbH assumes no liability.



User Manual and Reference Manual are available online.

► [www.mt.com/library](http://www.mt.com/library)



The FCC Supplier Declaration of Conformity is available online.

► <http://www.mt.com/ComplianceSearch>

### 2.1 Definitions of signal words and warning symbols

Safety notes contain important information on safety issues. Ignoring the safety notes may lead to personal injury, damage to the instrument, malfunctions and false results. Safety notes are marked with the following signal words and warning symbols:

#### Signal words

##### **WARNING**

A hazardous situation with medium risk, possibly resulting in death or severe injury if not avoided.

##### **NOTICE**

A hazardous situation with low risk, resulting in damage to the instrument, other material damage, malfunctions and erroneous results, or loss of data.

#### Warning symbols



Electrical shock

### 2.2 Product specific safety notes

#### Intended use

This instrument is designed to be used by trained staff. The SevenDirect™ SD50 pH/Ion Meter is intended for measuring pH, redox potential and ion concentrations.

Any other type of use and operation beyond the limits of use stated by Mettler-Toledo GmbH without consent from Mettler-Toledo GmbH is considered as not intended.

#### Responsibilities of the instrument owner

The instrument owner is the person holding the legal title to the instrument and who uses the instrument or authorizes any person to use it, or the person who is deemed by law to be the operator of the instrument. The instrument owner is responsible for the safety of all users of the instrument and third parties.

Mettler-Toledo GmbH assumes that the instrument owner trains users to safely use the instrument in their workplace and deal with potential hazards. Mettler-Toledo GmbH assumes that the instrument owner provides the necessary protective gear.

## Safety notes



### **WARNING**

#### **Death or serious injury due to electric shock**

Contact with parts that carry a live current can lead to death or injury.

- 1 Only use the METTLER TOLEDO AC/DC adapter designed for your instrument.
- 2 Keep all electrical cables and connections away from liquids and moisture.
- 3 Check the cables and the plugs for damage and replace damaged cables and plugs.



### **NOTICE**

#### **Damage to the instrument or malfunction due to the use of unsuitable parts**

- Only use parts from METTLER TOLEDO that are intended to be used with your instrument.

## **FCC Rules**

This device complies with Part 15 of the FCC Rules and Radio Interference Requirements of the Canadian Department of Communications. Operation is subject to the following conditions: (1) this device may not cause harmful interference, and (2) this device must accept any interference received, including interference that may cause undesired operation.

This equipment has been tested and found to comply with the limits for a Class A digital device, pursuant to Part 15 of the FCC rules. These limits are designed to provide reasonable protection against harmful interference when the equipment is operated in a commercial environment. This equipment generates, uses, and can radiate radio frequency energy and, if not installed and used in accordance with the instruction manual, may cause harmful interference to radio communications. Operation of this equipment in a residential area is likely to cause harmful interference in which case the user will be required to correct the interference at his own expense.

### 3 Design and Function

#### 3.1 Overview

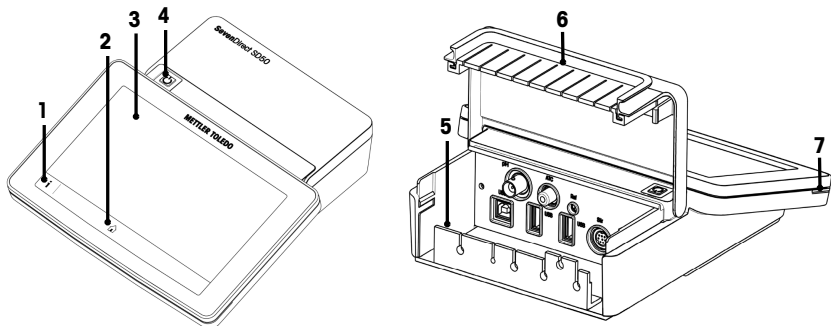

#	Description	Function
1	On screen help	To display help information for the current screen.
2	Home	To return from any menu level to <b>Home screen</b> .
3	Touch screen	Displays information and operates the meter.
4	Power switch	Switches the meter on/off. <ul style="list-style-type: none"> <li>Press to switch on.</li> <li>Press and hold for 3 seconds to switch off.</li> </ul>
5	Connector protection rubber	The removable dust rubber protects the meter from dust and the grooves are used for cable guidance.
6	Connector protection cover	<ul style="list-style-type: none"> <li>Closed to prevent dust from entering the meter.</li> <li>Open to access rear panel connections.</li> </ul>
7	Status light	Indicates whether the meter is: <ul style="list-style-type: none"> <li>ready for use: green</li> <li>in use: blinking green</li> <li>user intervention required: yellow</li> <li>blocked: red</li> </ul>

#### 3.2 Rear panel connections

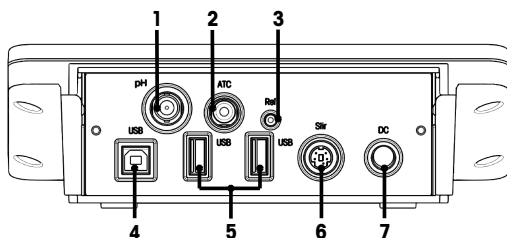

1	BNC socket for mV/pH signal input	2	RCA socket for temperature signal input
3	Reference socket for reference electrodes	4	USB-B interface
5	USB-A interface (USB-Stick, printer, barcode reader)	6	Mini DIN socket for EasyMix
7	DC power supply socket		



**Note** For best performance, use USB memory stick with FAT16 or FAT32 file system.

### 3.3 User interface

**Note** The screen shots in this manual are examples and can differ from the screen on your meter.

#### 3.3.1 Main sections at a glance

The **Home screen** (1) is the central navigation point where all the menus and settings can be found. The **Menu** (2), **Methods** (3) and **Results fly-in** (4) open when using the handles along the sides of the main screen. The **Result** (5) opens when tapping **List** from (4).



#### See also

- 📄 Home screen ▶ Page 7
- 📄 Menu ▶ Page 19
- 📄 Methods ▶ Page 35
- 📄 Results fly-in ▶ Page 52
- 📄 Result ▶ Page 49

#### 3.3.2 Home screen

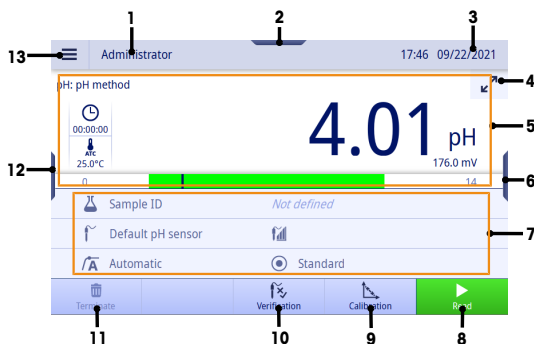

#	Description	Function
1	User name	Displays the name of the current user.
2	Methods handle	Enters into <b>Methods</b> to view and edit methods.
3	Date and time	Displays the current date and time. The format is set in <b>Menu &gt; Settings &gt; General</b> .
4	Activate / deactivate uFocus™ mode	Switches modes for the display representation. Details see [Display representation ▶ Page 8].
5	Measurement reading area	Displays the results of the current measurement, calibration or verification.
6	Results handle	Enters into <b>Results fly-in</b> to see the list of the latest 7 results.
7	Method information area	Displays the information about the sample, sensor and method.
8	<b>Read</b>	Starts measurements and confirms measurement results.
9	<b>Calibration</b>	Reviews sensor status, changes sensor and starts calibrations.
10	<b>Verification</b>	Reviews sensor status, changes sensor and starts verifications.
11	<b>Terminate</b>	Terminates the measurement, calibration or verification.
12	Menu handle	Enters into <b>Menu</b> to maintain settings, user management, sensors, buffers & standards and maintenance & service.
13	Menu button	









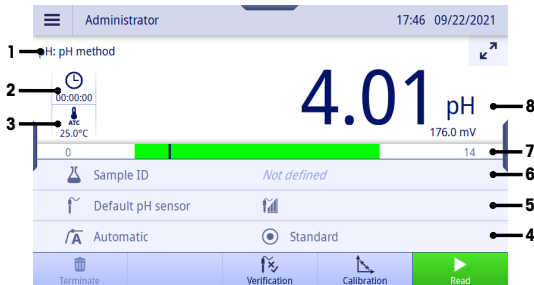
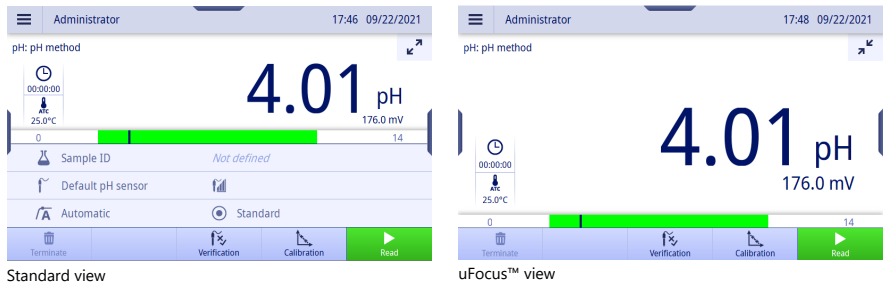



### See also

General ▶ Page 20

### 3.3.2.1 Display representation

There are two modes available for the display representation: the full-information screen with all the information displayed, and the measurement close-up screen uFocus™, where the method information area is hidden and the measurement information is shown in large font. To toggle between these views, touch Activate / deactivate uFocus™ mode button before, during or after a measurement.



#	Description	Function
1	Method ID	<p>Displays the measurement model and the name of the active method.</p> <ul style="list-style-type: none"> <li>• <b>'pH':</b> can perform pH measurement, pH sensor calibration and pH sensor verification</li> <li>• <b>'Ion':</b> can perform ion measurement, ion sensor calibration and ion sensor verification</li> <li>• <b>'Redox':</b> can perform redox measurement and redox sensor verification</li> </ul>
2	Duration	<ul style="list-style-type: none"> <li>• : displays the duration of the measurement.</li> <li>• : displays the number of data points which are already recorded.</li> </ul> <p>Only if <b>Methods &gt; Measure &gt; Interval reading</b> is active, you can tap to switch between these 2 modes.</p>
3	Temperature	<p>Displays the temperature.</p> <p>Tap to perform a temperature check while the meter is in idle state.</p> <ul style="list-style-type: none"> <li>• : gets the temperature value from the sample automatically.</li> <li>• : tap to change the temperature value used for the current measurement only.</li> </ul>
4	Endpoint type	<p>Displays the information of the endpoint type.</p> <p>If a user belonging to the <b>Administrator</b> user group is logged in, you can tap to enter the active method to adjust settings for the endpoint type and the stability criterion.</p> <ol style="list-style-type: none"> <li>1. Endpoint type, defined in <b>Methods &gt; Measure &gt; Endpoint type</b>. <ul style="list-style-type: none"> <li>–  <b>Automatic</b>: stops the measurement automatically when the signal is stable.</li> <li>–  <b>Manual</b>: manually stops the measurement by tapping <b>Manual endpoint</b>.</li> <li>–  <b>Timed</b>: stops the measurement after the predefined time.</li> </ul> </li> <li>2. Stability Criterion (pH only), defined in <b>Methods &gt; Measure &gt; Stability criteria</b>. Details see [Stability criteria ▶ Page 48]. <ul style="list-style-type: none"> <li>–  <b>Strict</b></li> <li>–  <b>Standard</b></li> <li>–  <b>Fast</b></li> </ul> </li> </ol>
5	Sensor name	<p>Displays the information of the selected sensor.</p> <p>Tap to change to another sensor if no sensor is defined in the method and no ISM sensor is connected.</p> <ol style="list-style-type: none"> <li>1. pH electrode condition <ul style="list-style-type: none"> <li>–  Slope: 95-105% / Offset: ±(0-20) mV (Electrode is in good condition)</li> <li>–  Slope: 94-90% / Offset: ±(20-35) mV (Electrode needs cleaning)</li> <li>–  Slope: 89-85% / Offset: ±(&gt;35) mV (Electrode is defective or too old)</li> </ul> </li> <li>2. Informs about whether a calibration is due based on: <ul style="list-style-type: none"> <li>– <b>Methods &gt; Calibration &gt; Calibration reminder</b></li> <li>– <b>Menu &gt; Settings &gt; Analysis settings &gt; Calibration expiry action</b></li> </ul> </li> <li>3. Inform about whether a verification is due based on: <ul style="list-style-type: none"> <li>– <b>Methods &gt; Verification &gt; Verification reminder</b></li> <li>– <b>Menu &gt; Settings &gt; Analysis settings &gt; Verification expiry action</b></li> </ul> </li> </ol>
6	Sample ID	<p>Displays the information of the sample ID.</p> <p>Tap to set the sample ID manually.</p>

#	Description	Function
7	Range indicator	<p>Only visible for pH measurement mode.</p> <p>The green area shows the range covered by the current calibration.</p> <p>The bold vertical line will move to indicate the current measured value.</p> <p>If <b>Methods &gt; Measure &gt; Limits</b> of the measurement are defined, the limits are also indicated on the bar, marked as vertical lines.</p>
8	Reading	<p>Displays the measurement value and used measurement unit.</p> <ul style="list-style-type: none"> <li>pH: raw value 'mV' with unit 'pH', 'mV'</li> <li>Ion: raw value 'mV' with unit 'pX', 'mg/L', 'mol/L', 'mmol/L', '%', 'ppm', 'mV'</li> <li>Redox: raw value 'mV' with unit 'mV', 'Rel.mV'</li> </ul>

### 3.3.3 How to operate the touch screen

The meter is operated by using a finger tapping on the touch screen.



#### NOTICE

##### **Danger of damaging the touch screen with pointed or sharp objects!**

Pressing on the touch screen with pointed or sharp objects may be damaged it.

- Operate the touch screen by applying gentle pressure with the pad of your finger.

#### 3.3.3.1 Selecting or activating an item

- Tap the item or function to be selected or activated.

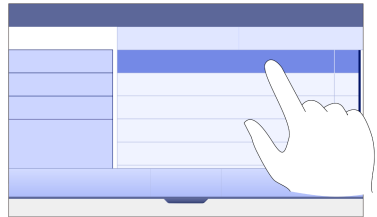

#### 3.3.3.2 Scrolling up and down

- 1 Place the finger on the screen.
- 2 Move the list or content up and down.

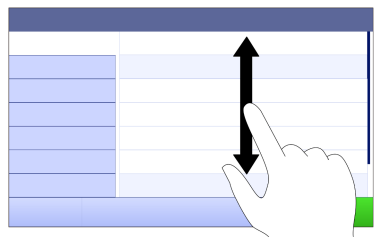

### 3.3.3.3 Accessing specific menus

The handles are placed along the sides of **Home screen**. Use the handles to access specific menus.

To use the handles, proceed as follows:

- Place the finger on the handle and slide the function window out or in.
- or -
- Swipe across the measurement reading area away from the handle of the menu which you want to open or close.
- or -
- Tap the handle symbol to open or close the function window.

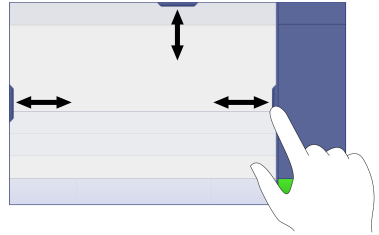

### 3.3.3.4 Secondary functions for list items

To access the secondary functions, proceed as follows:

- Place the finger on the triangle symbol ◀ and slide to the left to display the secondary functions.
- or -
- Swipe left across a list item to display its secondary functions and swipe right across to hide its secondary functions.
- or -
- Tap ◀ to display or hide the secondary functions.

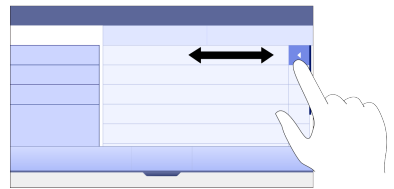

### 3.3.3.5 Entering characters and numbers

The instrument has different keyboard layouts of the alphanumeric input field which can be selected in **Menu > Settings > User settings > Language**. The following image is an example of the English keyboard.

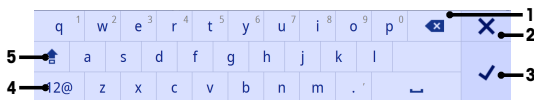

#	Description	Function
1	Backspace	Deletes the character left of the current cursor position. The cursor can be positioned by using the touch screen.
2	Discard	Closes the keyboard dialog and discards the input.
3	Confirm	Confirms the entered information.
4	Numbers and special characters	Switches to the keyboards for special characters and numbers.
5	Shift	Switches between lower or upper case letters. Double tap can engage caps lock.

### 3.3.3.6 Entering numbers and unit

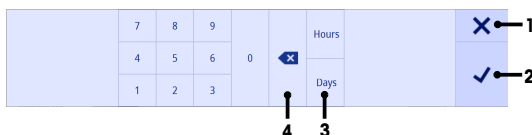

#	Description	Function
1	Discard	Closes the keyboard dialog and discards the input.
2	Confirm	Confirms the entered data.
3	Unit	Lists optional units. Tap to switch the unit. Only displayed if the unit can be changed.
4	Backspace	Deletes the number left of the current cursor position. The cursor can be positioned by using the touch screen.

### 3.3.3.7 Changing date and time

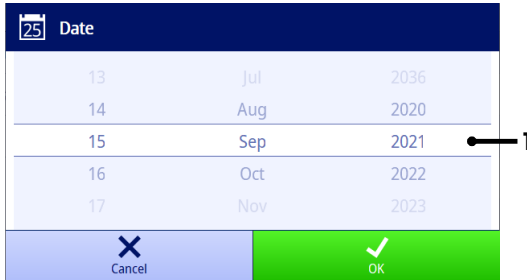

The display field (1) shows the defined date or time. Scroll to move the list up/down to change the display field.

**Note** The format of date and time can be defined in **Menu > Settings > General**.

## 4 Putting into Operation

### 4.1 Scope of delivery

Unpack the instrument and check the scope of delivery. Keep the calibration certificate in a safe place. SevenDirect™ is delivered with:

- AC adapter
- Electrode arm EasyPlace™ complete
- Protective cover
- EU Declaration of conformity
- Test report
- User Manual (print version)

### 4.2 Mounting EasyPlace™

- 1 Attach the base plate (1) to the pole (2) by tightening the Screws (3) by hand.
- 2 Put the Top Cover Pole (4) on the pole.
- 3 Insert the Sensor Holder (5) into the electrode arm (6).
- 4 Put the Parking Beaker Insert (7) into the Parking Beaker (8).
- 5 Put the Parking Beaker to the dedicated storage position (9).
- 6 Put the Sachet Holder (10) to the dedicated position (11), which is used to hold the buffers/standards.
- 7 Press the button (12) and slide up and down to adjust the height.
- 8 Rotate the electrode arm to adjust the sensor position.

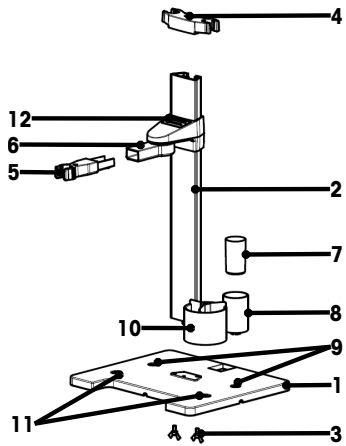

### 4.3 Installing power supply



#### **⚠ WARNING**

##### **Death or serious injury due to electric shock**

Contact with parts that carry a live current can lead to death or injury.

- 1 Only use the METTLER TOLEDO AC/DC adapter designed for your instrument.
- 2 Keep all electrical cables and connections away from liquids and moisture.
- 3 Check the cables and the plugs for damage and replace damaged cables and plugs.



#### **NOTICE**

##### **Danger of damage to the AC adapter due to overheating!**

If the AC adapter is covered or in a container, it is not sufficiently cooled and overheats.

- 1 Do not cover the AC adapter.
- 2 Do not put the AC adapter in a container.

The instrument is operated using an AC adapter. The AC adapter is suitable for all supply line voltages ranging from 100...240 V AC  $\pm 10\%$  and 50-60 Hz.

- 1 Insert the correct connector plug into the AC adapter until it is completely inserted.
  - 2 Connect the cable of the AC adapter with the DC socket of the instrument.
  - 3 Install the cables in such a way that they cannot be damaged or interfere with operation.
  - 4 Insert the plug of the AC/DC adapter into a power outlet that is easily accessible.
- ➔ To remove the connector plug, push the release button and withdraw the connector plug.

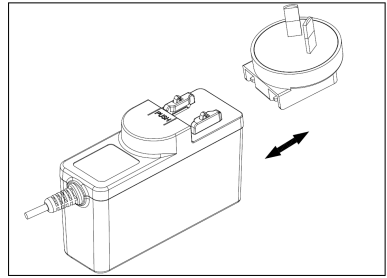

## 4.4 Switching the instrument on and off

### Switching the instrument on

- 1 Press the power switch.
  - ➔ The StatusLight turns on.
- 2 Wait for 1 - 2 seconds, the screen lights up and displays the startup image.
- 3 The instrument is initialized. The instrument will be ready for operation in about 25 seconds.
  - ➔ Login screen appears.

### Switching the instrument off



#### NOTICE

##### Risk of data loss when switching off

The data will be lost when switching off while any processes are active.

- Make sure no measurement, calibration, verification, transfer and printout is running before you switch off the instrument.

- 1 Press the power switch for 3 seconds.
- 2 The instrument stops running tasks and shuts down. This process will take some time.
  - ➔ The screen turns off.

## 4.5 First Startup Wizard

At first startup of the instrument or after a factory reset, a First Startup Wizard guides you through the major settings of the instrument.

- 1 Select a Language from the language list.
  - ➔ The user interface switches to the language selected immediately.
- 2 Tap **Next**.

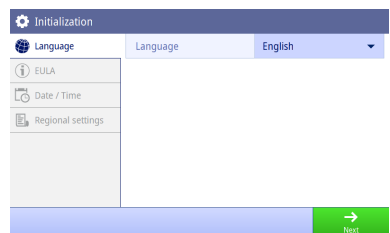



3 Scroll down to read the EULA and make it active.

4 Tap **Next**.



5 Set the date format, date and time one by one.

6 Tap **Next**.

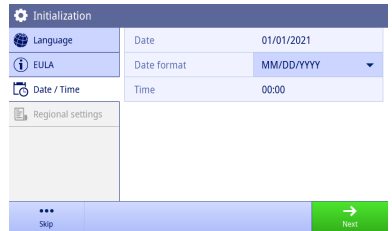

7 Select the temperature unit and default buffers.

8 Tap **Finish**.

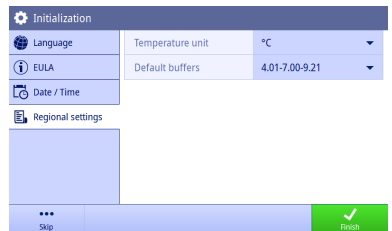

➔ Get into Login screen.

9 Tap the default user account without password to enter **Home screen**.

If you want to change settings made during the startup wizard, they are all available in the settings menu.

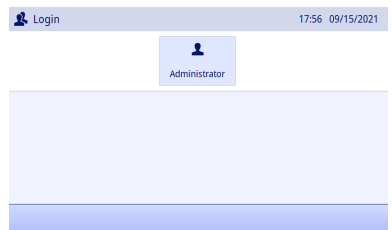

## 4.6 Connecting sensors

When connecting a sensor, make sure that the plugs are properly inserted. If you are using a sensor with a built-in temperature probe or a separate temperature probe, connect the second cable to the ATC socket.

### Example

- Connect a pH sensor to the BNC plug and if a temperature sensor, ISM or both are integrated, connect the RCA (Cinch) plug to the ATC input.

### ISM® sensor

When connecting an ISM® sensor to the meter, the **ISM** icon **ISM** appears on the display and the sensor name of the sensor chip is registered and appears on the display.

The calibration history, the initial data and the maximum temperature can be reviewed in the data memory.

**Note** We strongly recommend you to switch off the meter when disconnecting an ISM sensor. In doing so, you make sure that the sensor is not removed while the instrument is reading data from or writing data to the ISM-chip of the sensor.

## 5 Starting Analysis

### 5.1 Selecting a method

Before starting the analysis, you must first select a method. You can select a predefined or user-defined method directly from the method lists.

To select a method, proceed as follows:

- 1 Use the top handle to access into **Methods** menu.
- 2 Select a measurement mode from the side tab on the left.
- 3 Tap the method you want to start.  
➔ The measurement mode and method name is shown on **Home screen**.

### 5.2 Selecting a sensor

If the parameter in **Methods > Configuration > Sensor** is defined as 'Any' and no **ISM** sensor is connected, you can change a sensor on **Home screen** before starting an analysis.

To select a sensor, proceed as follows:

- 1 Tap the sensor name on **Home screen**.  
- or -  
Tap **Calibration > Change sensor**.  
- or -  
Tap **Verification > Change sensor**.  
➔ The names of all available sensors are listed.
- 2 Tap the sensor that you want to select.  
➔ The last calibration date of the sensor and the required buffers/standards are displayed.
- 3 Tap **Close** to go back to **Home screen**.  
- or -  
Tap **Start calibration** to start the calibration.  
- or -  
Tap **Start verification** to start the verification.

### 5.3 Starting a calibration

The meter allows you to perform pH calibrations with up to 5 points and ion calibrations with up to 5 points. The successful calibration data will be stored into the active sensor data.

#### Note

- The use of a temperature sensor or electrode with a built-in temperature sensor is recommended.
- If you use  (Manual) mode, you should enter the correct temperature value for each measurement and keep all buffers/standards and sample solutions at the set temperature.
- To ensure the most accurate readings, you should perform calibrations regularly.

#### Performing a Calibration

- Ensure that the appropriate buffers/standards have been selected.
- 1 Select an appropriate method according to [Selecting a method ▶ Page 16].
- 2 Select a sensor if necessary according to [Selecting a sensor ▶ Page 16].
- 3 Tap **Calibration**.
- 4 Tap **Start calibration**.
- 5 Enter the lot number if **Methods > Calibration > Check buffer lot number** is active and confirm with **OK**.  
➔ The sensor name, the endpoint type and buffers/standards points are displayed.
- 6 Place the sensor in a calibration buffer/standard.
- 7 Tap **Read**.  
➔ The font of the measurement values turns to light blue.
- 8 The measurement stops when the endpoint criterion is fulfilled. See [Endpoint criterion ▶ Page 18].

- ⇒ ✓ appears in front of the passed calibration point.
- 9 Rinse the sensor with deionized water and place the sensor in the next calibration buffer/standard.
- 10 Tap **Read**.
  - ⇒ The font of the measurement values turns to light blue.
- 11 The measurement stops when the endpoint criterion is fulfilled. See [Endpoint criterion ▶ Page 18].
  - ⇒ ✓ appears in front of the passed calibration point.
- 12 Rinse the sensor with deionized water and repeat the steps with all buffers/standards.
  - ⇒ A window pops up with calibration data.
- 13 Tap **OK (Adjust)** to save the result.
  - or -
  - Tap **Reject** to reject the calibration and return to **Home screen**.

### Finalize a Calibration in Advance

If **Home screen > Menu > Settings > Analysis settings > Finalize pH calibration at any point** is active, a button **Calculate** will display for the multi-point pH calibration. You can tap it to finalize the calibration in advance.

To finalize the calibration in advance, proceed as follows:

- The calibration is a multi-point pH calibration.
  - At least one calibration point of a multi-point calibration is passed.
- 1 Tap **Calculate**.
  - 2 Tap **OK (Adjust)** to save the result.
    - or -
    - Tap **Reject** to reject the calibration and return to **Home screen**.

The meter will do calibrations in the user-defined order in the active method. If one calibration point fails, you should redo this calibration point and cannot skip it.

However, if **Auto buffer recognition** of a pH method is active, the meter will automatically recognize the closest calibration point.

## 5.4 Starting a verification

The latest verification data will be stored into the data of the active sensor.

- Ensure that the appropriate buffers/standards have been selected.
- 1 Select an appropriate method according to [Selecting a method ▶ Page 16].
  - 2 Select a sensor if necessary according to [Selecting a sensor ▶ Page 16].
  - 3 Tap **Verification**.
  - 4 Tap **Start verification**.
  - 5 Enter the lot number if **Methods > Verification > Check buffer lot number** is active and confirm with **OK**.
    - ⇒ The verification point, sensor name, sensor status and the endpoint type are displayed.
  - 6 Tap **Read**.
  - 7 The measurement stops when the endpoint criterion is fulfilled. See [Endpoint criterion ▶ Page 18].
    - ⇒ A window pops up with verification data.
  - 8 Tap **OK**.

## 5.5 Starting a measurement

- 1 Select an appropriate method according to [Selecting a method ▶ Page 16].
- 2 Select a sensor if necessary according to [Selecting a sensor ▶ Page 16].
- 3 Tap Sample ID to enter the Sample ID if necessary.
- 4 Place the sensor in the sample.
- 5 Tap **Read**.
- 6 The measurement stops when the endpoint criterion is fulfilled. See [Endpoint criterion ▶ Page 18].

7 Tap **Confirm** if **Menu > Settings > Analysis settings > Confirm end of analysis** is active.

## 5.6 Interrupting analysis

Ongoing analyses can be interrupted anytime.

To interrupt an analysis, proceed as follows:

- 1 Tap **Terminate**.
- 2 Confirm with **OK** to go back to **Home screen**.  
- or -  
Tap **Cancel** to continue the analysis.

## 5.7 Endpoint criterion

The measurement will stop based on the setting in **Methods > Measure > Endpoint type**.

If **Endpoint type** is defined as:

- **Automatic:** The measurement will stop automatically, based on the programmed stability criteria.
- **Manual:** The measurement will only stop when you tap **Manual endpoint**.
- **Timed:** The measurement will stop after the defined time in **Methods > Measure > Endpoint time**.

If **Home screen > Menu > Settings > Analysis settings > Allow taking of manual endpoint** is active, you can also stop the measurement manually by tapping **Manual endpoint** during the measurement, whatever the **Endpoint type** is defined for.

## 5.8 Measurement status

### Measurement Reading

Measurement limit	In progress		Endpoint reached	
	Within limit	Out of limit	Within limit	Out of limit
Inactive	font: light blue		font: white	
	background: white		background: dark blue	
Active	font: light blue	font: red	font: white	
	background: white		background: green	background: red

### Temperature Reading

Temperature limit	In progress		Endpoint reached	
	Within limit	Out of limit	Within limit	Out of limit
Inactive	font: light blue		font: white	
	background: white		background: dark blue	
Active	font: light blue	font: red	font: white	
	background: white		background: green	background: red

## 6 Menu

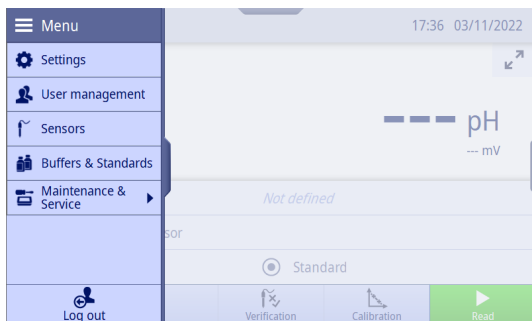

### 6.1 Logging in and out

#### Logging in

When the instrument switched on, the system starts up and enters into the Login screen first. You have to log in with your user account before you operate the instrument.

To log in, proceed as follows:

- 1 Select your user name from the user list on Login screen.
  - ➔ The selected user is highlighted.
- 2 If your user account has a password, enter the password.
  - OF -
  - If your user account doesn't have the password, you don't need to enter anything.

➔ Enter **Home screen**.

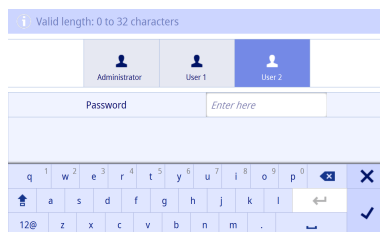

#### Logging out

You can log out of the instrument when there is no measurement, calibration, verification or data transfer running.

To log out, proceed as follows:

- 1 Use the menu handle or tap the menu button to enter **Menu**.
  - 2 Tap **Log out**.
- ➔ Enter Login screen.

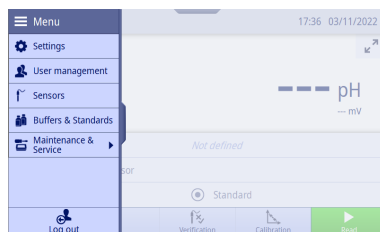

## 6.2 Global settings

Navigation: Home screen > Menu > Settings

Settings		
General	Date	03/11/2022
Peripherals	Date format	MM/DD/YYYY ▼
Analysis settings	Time	14:17
User settings	Temperature unit	°C ▼
	Status light	<input checked="" type="checkbox"/>
	Brightness of status light	80% ▼
	Glove mode	<input type="checkbox"/>
Cancel		Save

In **Settings**, you can make general instrument settings that apply to all users. The settings here can only be changed by users in the **Administrator** user group.

**Note** Settings are only applied when confirming with **Save**.

### 6.2.1 General

You can view and set date and time, temperature unit, status light and brightness here.

**Note** Only users in the **Administrator** user group can change the settings.

Parameter	Description	Values
Date	Sets the current date.	-
Date format	Defines the format for displaying the date.	MM/DD/YYYY   DD/MM/YYYY   YYYY/MM/DD   DD-MMM-YYYY
Time	Defines the time format and sets the current time.	-
Temperature unit	Defines the temperature unit to be shown, stored, transferred and printed.  Predefined buffer groups and standard lists always use the unit °C as the reference temperature. For customized buffer groups and standard lists, the unit of the temperature depends on the active temperature unit.	°C   °F
Status light	<b>Active:</b> The instrument will light up in different colors synchronized with the notification bar. <ul style="list-style-type: none"> <li>Green: OK</li> <li>Yellow: Action required</li> <li>Red: Error</li> <li>Flashing Green: Busy</li> </ul>	Active   Inactive
Brightness of status light	The brightness changes immediately when changing the value from the list.  Displayed if <b>Status light</b> is activated.	20%   40%   60%   80%   100%
Glove mode	<b>Active:</b> The screen sensitivity is increased.	Active   Inactive

### 6.2.2 Peripherals

You can enable or disable each transfer settings of the meter here.

**Note** Only users in the **Administrator** user group can change the settings.

Parameter	Description	Values
Transfer to printer	<p><b>Active:</b> The instrument will do a required resource check before the measurement, calibration and verification.</p> <p>If there is no printer connected, you cannot do any analysis. If a printer is connected successfully, the result of the measurement, calibration and verification will be printed once the analysis is finished.</p>	Active   Inactive
Print after each interval	<p><b>Active:</b> The measurement data will be printed out after each interval time which is defined in the activated method &gt; <b>Measure</b> &gt; <b>Interval time</b>, until the measurement is finished.</p> <p>Displayed if <b>Transfer to printer</b> is activated.</p>	Active   Inactive
Transfer to USB memory stick	<p><b>Active:</b> The instrument will do a required resource check before measurement, calibration and verification.</p> <p>If there is no USB memory stick connected, you cannot do any analysis. If an USB memory stick is connected, the measurement, calibration and verification results will be transferred to the USB memory stick once the analysis is finished.</p>	Active   Inactive
Transfer to EasyDirect pH	<p><b>Active:</b> The instrument will do a required resource check before the measurement, calibration and verification.</p> <p>If the PC software is not connected, you cannot do any analysis. If the PC software is connected, the result of the measurement, calibration and verification will be transferred to the PC.</p>	Active   Inactive

### 6.2.3 Analysis settings

You can set additional analysis settings outside method settings here.

**Note** Only users in the **Administrator** user group can change the settings.

Parameter	Description	Values
Sample ID mandatory	<p><b>Active:</b> A sample ID must be available for each measurement.</p> <p>If the user attempts to start a measurement and no sample ID is available, an error message appears and the measurement cannot be started.</p>	Active   Inactive
Allow taking of manual endpoint	<p><b>Active:</b> You can take the endpoint manually by tapping <b>Manual endpoint</b> during the measurement, calibration and verification.</p>	Active   Inactive
Confirm end of analysis	<p><b>Active:</b> All endpoint results of the measurement, calibration and verification are shown on screen. The measurement is only completed when <b>Confirm</b> is tapped.</p>	Active   Inactive
Save result on instrument	<p><b>Active:</b> The results of the measurement, calibration and verification are stored in the meter.</p>	Active   Inactive
Range indicator tolerance	<p>Sets a tolerance value for the calibration range which shows in the range indicator for pH measurement mode.</p>	0.000...20.000 pH
Calibration expiry action	<ul style="list-style-type: none"> <li>• <b>Warn:</b> If <b>Calibration reminder</b> of the active method is activated, the meter gives a warning when using a sensor with an expired calibration. However, you <b>CAN</b> still perform measurements with this sensor.</li> <li>• <b>Warn and Block:</b> If <b>Calibration reminder</b> of the activated method is activated, the meter gives a warning when using a sensor with an expired calibration. In addition, you <b>CANNOT</b> perform measurements with this sensor.</li> </ul>	Warn   Warn and Block

Parameter	Description	Values
Verification expiry action	<ul style="list-style-type: none"> <li><b>Warn:</b> If <b>Verification reminder</b> of the activated method is activated, the meter gives a warning when using a sensor with an expired verification. But you <b>CAN</b> still perform measurements with this sensor.</li> <li><b>Warn and Block:</b> If <b>Verification reminder</b> of the activated method is activated, the meter gives a warning when using a sensor with an expired verification. In addition, you <b>CANNOT</b> perform measurements with this sensor.</li> </ul>	Warn   Warn and Block
Life span expiration action	<ul style="list-style-type: none"> <li><b>Warn:</b> If <b>Monitoring life span</b> of the activated sensor is activated, the meter gives a warning when the sensor with an expired life span. But you <b>CAN</b> still perform measurements with this sensor.</li> <li><b>Warn and Block:</b> If <b>Monitoring life span</b> of the activated sensor is activated, the meter gives a warning when the sensor with an expired life span. In addition, you <b>CANNOT</b> perform measurements with this sensor.</li> </ul>	Warn   Warn and Block

## 6.2.4 User settings

**User settings** contains the settings that can be made specifically for each user.

Parameter	Description	Values
Language	Sets the language for the screen text display.	English   German   French   Italian   Spanish   Portuguese   Polish   Russian   Turkish   Thai   Korean   Japanese   Chinese (Simplified)
Keyboard layout	Defines the layout of the alphanumeric input field.	English   French   German
Screen brightness	The brightness changes immediately when changing the value from the list.	10%   20%   30%   40%   50%   60%   70%   80%   90%   100%
Screen saver	<p><b>Active:</b> The screen will become dark when there is no action on meter during the defined screen save wait time period.</p> <p>The user can touch any area to light up the screen. When there's a message or system event popup, the screen also will light up.</p>	Active   Inactive
Wait time	Displayed if <b>Screen saver</b> is activated.	1...120 min
Beep when pushing a button	<b>Active:</b> A beeping sound is played when you tap on the touch screen.	Active   Inactive
Beep on error message	<b>Active:</b> A beeping sound is played when an error message is displayed.	Active   Inactive
Beep on stability signal	<b>Active:</b> A beeping sound is played when a measurement result is stable.	Active   Inactive
Beep on notification	<b>Active:</b> A beeping sound is played when a notification is displayed.	Active   Inactive



## 6.3 User management

Navigation: Home screen > Menu > User management

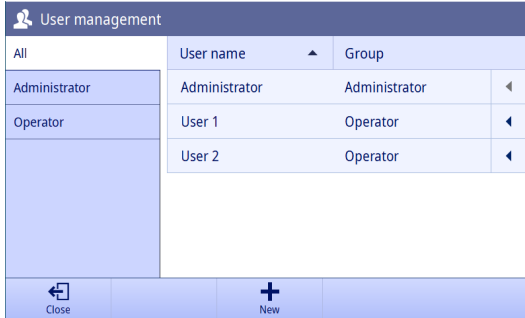

User management		
All	User name	Group
Administrator	Administrator	Administrator
Operator	User 1	Operator
	User 2	Operator

In **User management** you can manage the settings for user accounts and passwords. A maximum of 30 different users can be defined. Users can be created, deleted and edited.

User can only be managed by users in the appropriate user group.

The instrument has two user group levels. One is **Administrator** and the other is **Operator**. The user in **Administrator** user group has full access rights while the user in the **Operator** user group has limited access rights. There is a default user with a predefined user name (user name: Administrator, user group: Administrator) that cannot be deleted. It is recommended to change its password after the initial boot.

### Note

- Only **Administrator** can view all users while **Operator** can only view their own.
- The user which is currently logged in cannot be deleted.

### 6.3.1 Creating a new user

Only users in the **Administrator** user group can create a new user.

To create a new user, proceed as follows:

- Logged-in user belongs to the user group **Administrator**.
- Enter **User management**.
- 1 Tap **New**.
- 2 Define **User name**, **Group**, **Password** and **Confirm password**.
  - ➔ If the user name is repeated, a warning message appears and **User name** changes to the original one.
- 3 Tap **Save** to create the new user.
  - ➔ If **Password** and **Confirm password** don't match, an error message appears and the new user cannot be created. You need to change the passwords to be the same.



New User 1	
User 1	User name: User 1
	Group: Operator
	Created on: 03/13/2022
	Created by: Administrator
	Password: Not defined
	Confirm password: Not defined

Parameter	Description	Values
User name	Defines the user name which uniquely identifies him to the system. Maximum 14 characters.	-
Group	Assignment of the user ID to a user group. Depending on the user group, the user has various rights.	Administrator   Operator
Created on	Information on date and time of account creation.	-
Created by	Information on the administrator logged in at time of account creation.	-
Password	Maximum 32 characters, including upper and lower case letters, numbers and symbols. If they are blank, the user doesn't need to enter a password when logging in.	-
Confirm password	Double check the password.	-

### 6.3.2 Deleting an user

Only the users in the **Administrator** user group can delete a user.

The following users cannot be deleted:

- The system predefined user 'Administrator'.
- The current logged-in user.

To delete an user, proceed as follows:

- Logged-in user belongs to the user group **Administrator**.
- Enter **User management**.

- 1 Use the handle after the user name you want to delete.
- 2 Tap **Delete**.

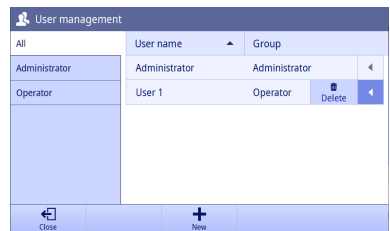

- 3 Confirm with **OK**.

➔ The user is removed from the user list.

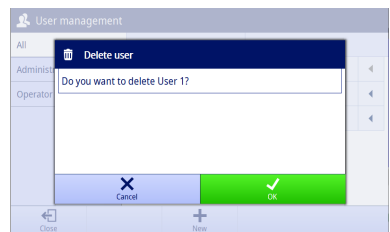

### 6.3.3 Changing the password

The users in the **Administrator** user group can change each user's password. The users in the **Operator** user group can only change its own password.

To change the password of the user, proceed as follows:

- Enter **User management**.

- 1 Tap the user name you want to change.
- 2 Tap **Change password**.

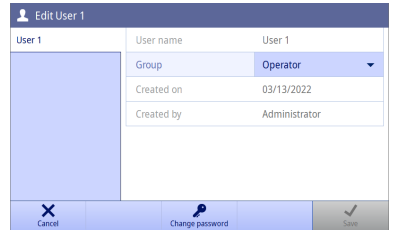

- 3 Enter **New password** and **Confirm password**.

**Note** These two passwords must be the same.

- 4 Confirm with **OK**.

- 5 Tap **Save**.

**Note** Changes are only made when confirming with **Save**.

⇒ If **Password** and **Confirm password** don't match, an error message appears and the password cannot be changed. You have to change the passwords to be the same.

⇒ You have to use new password to login after logging out or screen saving.

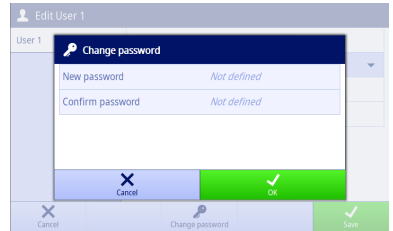

### 6.3.4 Editing User Group

The users in the **Administrator** user group can change each user's user group.

To edit a user's user group, proceed as follows:

- Logged-in user belongs to the user group **Administrator**.

- Enter **User management**.

- 1 Tap the user name you want to change.

⇒ **Save** function is inactive.

- 2 Change **Group** from the drop list.

⇒ **Save** function is active.

- 3 Tap **Save**.

**Note** Changes are only made when confirming with **Save**.

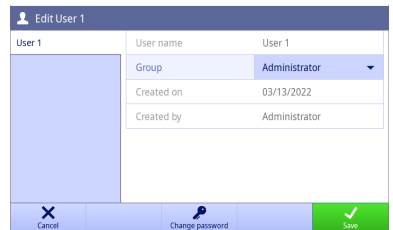

## 6.4 Sensors

Navigation: Home screen > Menu > Sensors

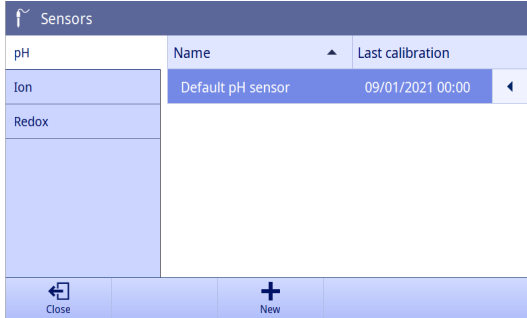

Sensors for pH, redox and ion can be connected to the instrument. One default sensor per sensor type is predefined. Each method can only select the sensors with the matched sensor type.

Sensors can be created, modified and deleted. The usable life and life span of a sensor can be set and monitored. If a sensor is used for an active method, it is highlighted.

SD50 can create a maximum of 10 pH sensors, 10 ion sensor and 10 redox sensors.

**Note** Digital ISM® sensors are detected automatically.

### 6.4.1 Creating a sensor

To create a new sensor, proceed as follows:

- Logged-in user belongs to the user group **Administrator**.
  - Enter **Sensors** menu.
- 1 Tap **New**.
  - 2 Select the measurement mode.

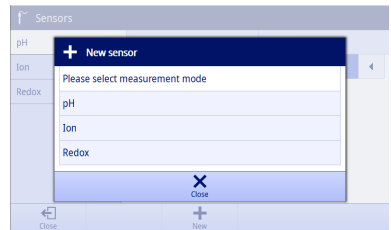

- 3 Select between the side tab on the left to define parameters.
  - 4 Tap **Save**.  
**Note** Changes are only made when confirming with **Save**.
- ➔ The new sensor is added into the sensor list.

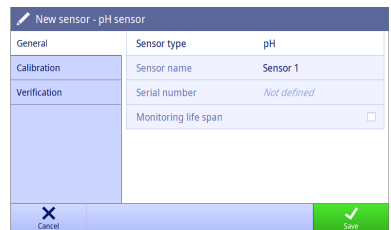

### 6.4.2 Deleting a sensor

The following sensors cannot be deleted:

- Attached **ISM** sensors
- The last sensor of this sensor type

To delete a sensor, proceed as follows:

- Logged-in user belongs to the user group **Administrator**.
  - Enter **Sensors** menu.
- 1 Use the handle after the sensor that you want to delete.
  - 2 Tap **Delete**.

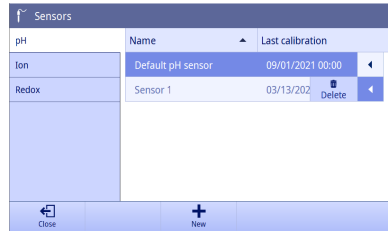

- 3 Confirm with **OK**.
- ➔ The sensor is removed from the sensor list.

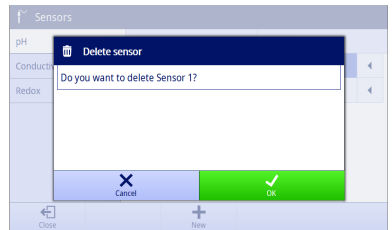

### 6.4.3 Editing a sensor

If the sensor is not used in a running measurement, verification or calibration, you can set the name, serial number and life span of this sensor.

**Note** You cannot edit the name or serial number for an **ISM®** sensor.

To edit a sensor, proceed as follows:

- Logged-in user belongs to the user group **Administrator**.
  - Enter **Sensors** menu.
- 1 Tap the sensor that you want to edit.
  - 2 Select between the side tab on the left to define parameters.
  - 3 Tap **Save**.
- Note** Changes are only made when confirming with **Save**.

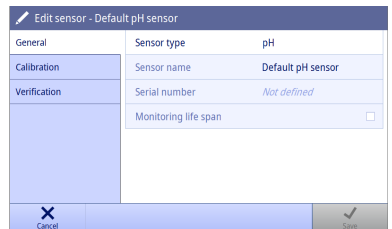

### 6.4.4 pH Sensor Parameters

#### General

Display and modify the general settings of the sensor.

Parameter	Description	Values
Sensor type	Information on the type of the sensor.	pH
Sensor name	Defines the name of the sensor. Maximum 16 characters.	-
Serial number	Defines the serial number of the sensor. Maximum 12 characters.	-

Monitoring life span	<b>Active:</b> The instrument checks the life span of the sensor at regular intervals and takes action based on <b>Menu &gt; Settings &gt; Analysis settings &gt; Life span expiration action.</b>	Active   Inactive
Initial operation	Defines the initial operation date of the sensor. Displayed if <b>Monitoring life span</b> is activated.	-
Life span	Defines the life span of the sensor. Displayed if <b>Monitoring life span</b> is activated.	1...100 Month(s)
Expiry date	Information on the expiry date. Displayed if <b>Monitoring life span</b> is activated.	-

### Calibration

Display the current used calibration data of the sensor. The data is automatically stored after calibration finished successfully. You cannot modify any data here.

Parameter	Description	Values
Offset	Information on offset.	-
Slope	Information on the slope.	-
Calibration procedure	Information on calibration procedure.	-
Date / Time of calibration	Information on date and time of calibration.	-
Calibrated by	Information on the user name of the user who performed the calibration.	-

### Verification

Display the current used verification data of the sensor. The data is automatically stored after verification finished. You cannot modify any data here.

Parameter	Description	Values
Verification result	Information on the verification result.	Pass   Failed
Verification buffer	Information on the verification buffer.	-
Verification criteria	Information on the verification criteria.	-
Method	Information on the name of the method which is used for the verification.	-
Date / Time of verification	Information on date and time of the verification.	-
Verified by	Information on the user name of the user who performed the verification.	-

## 6.4.5 Redox Sensor Parameters

### General

Display and modify the general settings of the sensor.

Parameter	Description	Values
Sensor type	Information on the type of the sensor.	Redox
Sensor name	Defines the name of the sensor. Maximum 16 characters.	-
Serial number	Defines the serial number of the sensor. Maximum 12 characters.	-

Monitoring life span	<b>Active:</b> The instrument checks the life span of the sensor at regular intervals and takes action based on <b>Menu &gt; Settings &gt; Analysis settings &gt; Life span expiration action.</b>	Active   Inactive
Initial operation	Defines the initial operation date of the sensor. Displayed if <b>Monitoring life span</b> is activated.	-
Life span	Defines the life span of the sensor. Displayed if <b>Monitoring life span</b> is activated.	1...100 Month(s)
Expiry date	Information on the expiry date. Displayed if <b>Monitoring life span</b> is activated.	-

### Verification

Display the current used verification data of the sensor. The data is automatically stored after verification finished. You cannot modify any data here.

Parameter	Description	Values
Verification result	Information on the verification result.	Pass   Failed
Reference value	Information on the reference value.	-
Verification criteria	Information on the verification criteria.	-
Method	Information on the name of the method which is used for the verification.	-
Date / Time of verification	Information on date and time of the verification.	-
Verified by	Information on the user name of the user who performed the verification.	-

## 6.4.6 Ion Sensor Parameters

### General

Display and modify the general settings of the sensor.

Parameter	Description	Values
Sensor type	Information on the type of the sensor.	Ion
Ion type	Defines the ion type.	Ag <sup>+</sup>   Ba <sup>2+</sup>   BF <sub>4</sub> <sup>-</sup>   Br <sup>-</sup>   Ca <sup>2+</sup>   Cd <sup>2+</sup>   Cl <sup>-</sup>   CN <sup>-</sup>   Cu <sup>2+</sup>   F <sup>-</sup>   I <sup>-</sup>   K <sup>+</sup>   Li <sup>+</sup>   Na <sup>+</sup>   NH <sub>4</sub> <sup>+</sup>   NO <sub>3</sub> <sup>-</sup>   Pb <sup>2+</sup>   S <sup>2-</sup>   SCN <sup>-</sup>   Other
Molar mass	Defines the ion type. Displayed if <b>Ion type = Other.</b>	1.00000... 1000.00000 g/mol
Ion charge	Defines the ion charge. Displayed if <b>Ion type = Other.</b>	-1   +1   +2   +3
Sensor name	Defines the name of the sensor. Maximum 16 characters.	-
Serial number	Defines the serial number of the sensor. Maximum 12 characters.	-
Monitoring life span	<b>Active:</b> The instrument checks the life span of the sensor at regular intervals and takes action based on <b>Menu &gt; Settings &gt; Analysis settings &gt; Life span expiration action.</b>	Active   Inactive
Initial operation	Defines the initial operation date of the sensor. Displayed if <b>Monitoring life span</b> is activated.	-

Life span	Defines the life span of the sensor. Displayed if <b>Monitoring life span</b> is activated.	1...100 Month(s)
Expiry date	Information on the expiry date. Displayed if <b>Monitoring life span</b> is activated.	-

### Calibration

Display the current used calibration data of the sensor. The data is automatically stored after calibration finished successfully. You cannot modify any data here.

Parameter	Description	Values
Offset	Information on offset.	-
Slope	Information on the slope.	-
Calibration procedure	Information on calibration procedure.	-
Date / Time of calibration	Information on date and time of calibration.	-
Calibrated by	Information on the user name of the user who performed the calibration.	-

### Verification

Display the current used verification data of the sensor. The data is automatically stored after verification finished. You cannot modify any data here.

Parameter	Description	Values
Verification result	Information on the verification result.	Pass   Failed
Verification standard	Information on the verification standard.	-
Verification criteria	Information on the verification criteria.	-
Method	Information on the name of the method which is used for the verification.	-
Date / Time of verification	Information on date and time of the verification.	-
Verified by	Information on the user name of the user who performed the verification.	-

## 6.5 Buffers & Standards

Navigation: Home screen > Menu > Buffers & Standards

Buffers & Standards			
pH	Name	Reference temperature(°C)	
Ion	METTLER TOLEDO	25.0	◀
	MT Europe	25.0	◀
	MT USA	25.0	◀
	ChP 2020	25.0	◀
	DIN(19266)/NIST	25.0	◀
	DIN(19267)	25.0	◀



In **Buffers & Standards**, you can view all predefined pH buffer groups and Ion standard lists and view all buffer and standard values at different temperatures. You can neither delete nor edit any predefined buffer group and Ion standard list.

If the user group of your user account is **Administrator**, you can create a maximum of 10 customized buffer groups and 10 customized Ion standard lists. You can also modify and delete them.

### 6.5.1 Creating customized buffer group / standard list

To create a customized buffer group or standard list, proceed as follows:

- Logged-in user belongs to the user group **Administrator**.

- Enter **Buffers & Standards** menu.

- 1 Tap **New** to create a buffer group / standard list.
  - OR -
  - Use the handle after the buffer group / standard list can delete it.

- 2 Select the measurement mode.

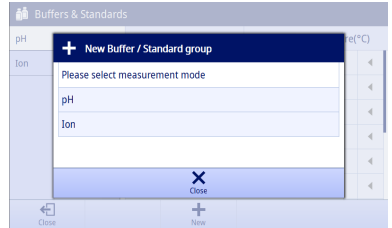

- 3 Set **Name** and **Reference temperature** for the buffer group / standard list.

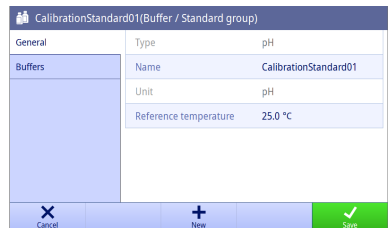

- 4 Tap **New** to add buffers / standards.
  - OR -
  - Use the handle after the buffers / standards to delete it.

- 5 Set **Name** for the buffer / standard.

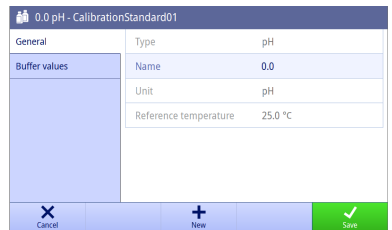

- 6 Tap **New** to add buffer / standard values.
  - OR -
  - Use the handle after the buffer / standard values to delete it.

- 7 Tap the field to set the temperature and value.

- 8 Tap **OK** to save buffer / standard values.

- 9 Tap **Save** to save buffers / standards and the buffer group / standard list.

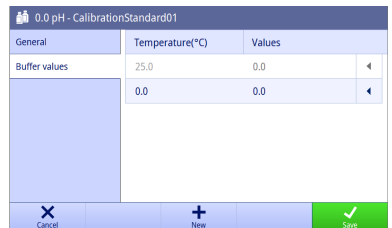

**Note** Once the buffer group / standard list is created, the reference temperature cannot be changed anymore.

## 6.6 Maintenance & Service

Navigation: Home screen > Menu > Maintenance & Service

Menu	
Settings	Instrument
User management	Service
Sensors	Peripheral status
Buffers & Standards	Import / Export
Maintenance & Service	Update
	Firmware history
	Factory Reset
Log out	

If you are logged in with the user in the **Administrator** user group, the following functions are available:

- **Instrument**
- **Service**
- **Peripheral status**
- **Import / Export**
- **Update**
- **Firmware history**
- **Factory Reset**

If you are logged in with the user in the **Operator** user group, you can only view **Instrument**.

### 6.6.1 Instrument

Navigation: Home screen > Menu > Maintenance & Service > Instrument

In the screen, you can see the following information of the instrument:

- **Instrument type**
- **Instrument serial number**
- **Instrument software version**
- **Instrument hardware version**
- **Last service date**
- **License declaration**
- **Open source license**

### 6.6.2 Service

Navigation: Home screen > Menu > Maintenance & Service > Service

In the screen, a list is shown with METTLER TOLEDO maintenance information. Each entry contains information about the date of last maintenance and the user name.

#### Set service life

Navigation: Home screen > Menu > Maintenance & Service > Service > Settings

Define the parameter for the service life to determine the date of the next maintenance interval. You can set a reminder to be informed on the upcoming maintenance. The following parameters can be set:

Parameter	Description	Values
Service life	Sets the maintenance intervals.	0...750 Day(s)

Parameter	Description	Values
Reminder	<b>Active:</b> A reminder informs about the days before the next maintenance takes place.	Active   Inactive
Days before expiration	Defines how many days before the expiration to inform the reminder. <b>Days before expiration</b> must be smaller than <b>Reminder</b> . Displayed if <b>Reminder</b> is activated.	0...1000 Day(s)

### 6.6.3 Peripherals status

#### Navigation: Home screen > Menu > Maintenance & Service > Peripheral status

In this screen, you can see a list of devices that can be connected to the instrument. You can also check each status of these devices.

The following devices can be checked for connection:

- **Printer**
- **USB memory stick**
- **Barcode reader**
- **Stirrer**
- **PC**

### 6.6.4 Import / Export

#### Navigation: Home screen > Menu > Maintenance & Service > Import / Export

In the screen, you can either transfer data to or from USB sticks. Using a Memory copy is an easy way to transfer the settings from one instrument to another. Then quickly you have installed two instruments with identical functions.

The following data can be imported or exported:

- Methods
- Sensors
- Buffers & Standards
- User management
- Memory copy
- Log file

#### Note

- The function **Import / Export** is only possible when a USB stick is connected and no task is running.
- All the saved results, analysis data, METTLER TOLEDO tables and predefined buffer groups / standard lists are not contained in a memory copy.
- When you import or export user management settings, the entire user management settings, with all users and their properties, will be imported or exported.
- You can create and import a backup copy only when you are logged in with the user in the **Administrator** user group.
- Do not change the filenames of exported files.
- When importing a memory copy or user management, the instrument will reboot after the import is complete.

### 6.6.5 Update

#### Navigation: Home screen > Menu > Service > Update

In the screen, you can manage firmware updates of the instrument and modules. Data can be transferred from USB sticks.

## Note

- You can implement a firmware update only when you are logged in with the user in the **Administrator** user group.
- METTLER TOLEDO provides additional information for updating instruments. These instructions will be part of the firmware update.

### 6.6.6 Firmware history

#### Navigation: Home screen > Menu > Maintenance & Service > Firmware history

You must log in with the user in the **Administrator** user group to see the screen. In the screen, a list shows all the firmware updates. The first entry on the list corresponds to initial operation.

All list entries show the following information:

- **Date:** The date of the installation.
- **Firmware version:** The software version installed.

### 6.6.7 Factory reset

#### Navigation: Home screen > Menu > Maintenance & Service > Factory Reset

You must log in with the user in the **Administrator** user group to see the screen. In the screen, you can reset all instrument settings to factory settings. A pop-up window informs you that all existing data and settings will be deleted.

**Note** If reset is performed, all created data, amendments, settings, setup entries and results will be lost.

Please create a **Memory copy** before you reset to factory settings.

To reset to factory settings, proceed as follows:

1 Tap **Factory Reset**.

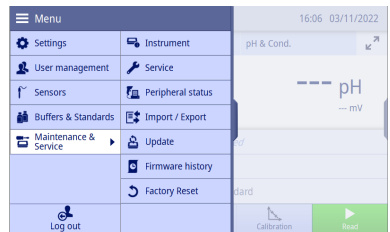

2 Tap **OK**.

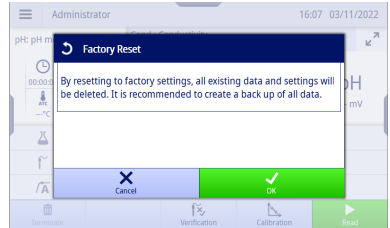

3 Tap **OK**.

➔ The instrument is shutting down and restarts with the First Startup Wizard. All the data is deleted.

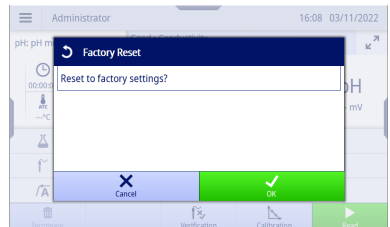

## 7 Methods

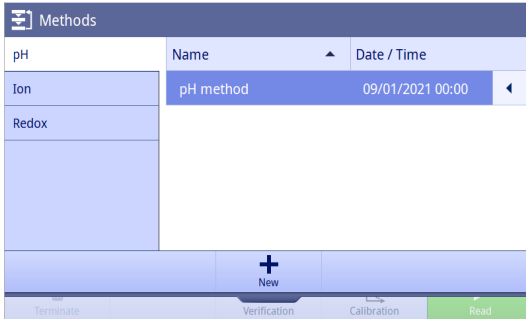

A method combines all parameters for a specific measurement procedure, including its associated calibration and verification. When settings are grouped into methods, it is easy and convenient to switch between the appropriate settings for different applications. It makes sure that no setting is left out.

The instrument predefines a method with default parameters for each measurement mode.

The active method is highlighted.

**Note** The images in this section show examples of the pH method and can differ from your instrument.

### 7.1 Adding a new method

To add a new method, proceed as follows:

- Enter **Methods**.
- 1 Tap **New** to create a new method.
- 2 Tap **pH**, **Ion** or **Redox** to select the measurement mode.

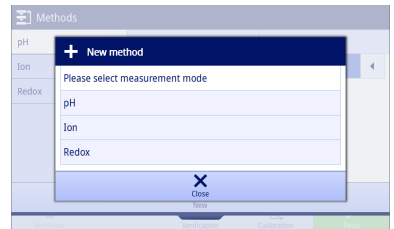

- 3 Select between the side tab on the left to define parameters.

- 4 Tap **Save**.

**Note** Changes are only made when confirming with **Save**.

- ➔ Go back to **Home screen**.
- ➔ The active method is updated to the newly created one.

**Note** The maximum number of methods across all method types is 20.

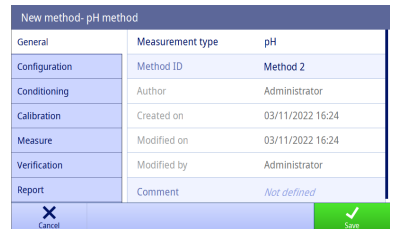

## 7.2 Cloning a method

To clone a method, proceed as follows:

- Enter **Methods**.

- 1 Select a measurement mode from the side tab on the left.
- 2 Use the handle after the method to access additional functions.

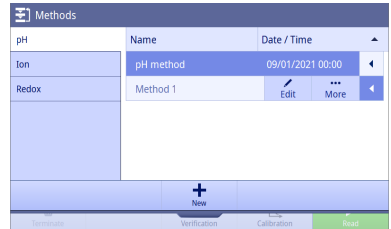

- 3 Tap **More**.



- 4 Tap **Duplicate**.

➔ A new method with the same parameters as the original one appears to be edited.

- 5 Select between the side tab on the left to define parameters.

➔ Go back to **Home screen**.

➔ The active method is updated to the newly created one.

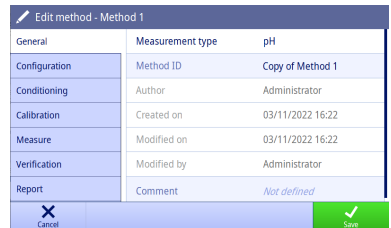

## 7.3 Deleting a method

To delete a method, proceed as follows:

- Enter **Methods**.

- 1 Select a measurement mode from the side tab on the left.
- 2 Use the handle after the method to access additional functions.

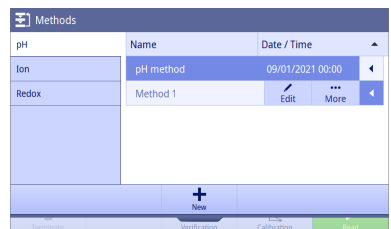

3 Tap **More**.

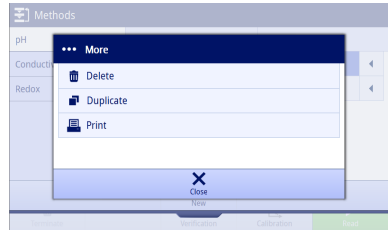

4 Tap **Delete**.

5 Confirm with **OK**.

➔ The method disappears from the method list immediately.

**Note** The activated method cannot be deleted.

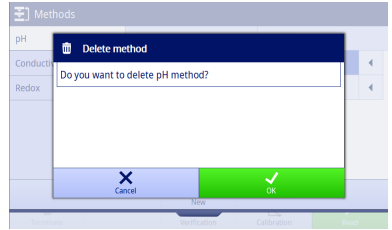

## 7.4 Editing a method

To edit a method, proceed as follows:

■ Enter **Methods**.

1 Select a measurement mode from the side tab on the left.

2 Use the handle after the method to access additional functions.

3 Tap **Edit**.

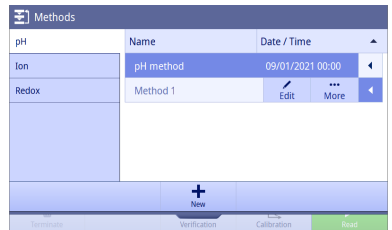

4 Select between the side tab on the left to define parameters.

5 Tap **Save**.

**Note** Changes are only made when confirming with **Save**.

➔ Go back to **Home screen**.

➔ The active method is updated to the modified one.

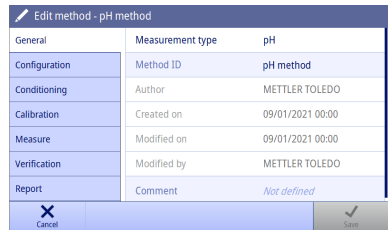

## 7.5 Printing a method

To print a method, proceed as follows:

- Enter **Methods**.
  - A printer is connected successfully.
- 1 Select a measurement mode from the side tab on the left.
  - 2 Use the handle after the method to access additional functions.
- 
- 3 Tap **More**.
  - 4 Tap **Print**.
- ➔ The method details are printed on the connected printer according to the format defined in **Methods > Report > Print format**.

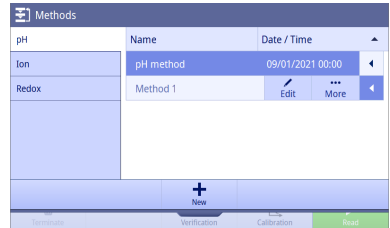

## 7.6 pH method parameters

### General

Parameter	Description	Values
Measurement type	Information on the measurement type.	pH
Method ID	Defines the method name which uniquely identifies him to the system. Maximum 30 characters.	-
Author	Information on the administrator logged in at time of the method creation.	-
Created on	Information on date and time of the method creation.	-
Modified on	Information on date and time of the method modification.	-
Modified by	Information on the administrator logged in at time of the method modification.	-
Comment	Defines some comments. Maximum 128 characters.	-

### Configuration

Parameter	Description	Values
Sensor	Select a sensor from the list of defined sensors if the method always runs with the same sensor. <b>Any:</b> You can select any suitable sensor before calibration, verification or measurement.	Any   List of defined sensors



Temperature capture	Select the temperature capture mode. <ul style="list-style-type: none"> <li>• <b>Sensor:</b> Uses the temperature measured by a connected temperature sensor.</li> <li>• <b>Manual:</b> Uses your input temperature value.</li> <li>• <b>Auto-Recognition:</b> Uses automatic temperature correction if a temperature sensor is connected and manual temperature correction otherwise..</li> </ul>	Sensor   Manual   Auto-Recognition
Sensor type	Select the sensor type. For temperatures below 100 °C, select <b>Auto</b> . For temperatures above 100 °C, select the suitable temperature sensor. Displayed if <b>Temperature capture = Sensor</b> or <b>Auto-Recognition</b> .	Auto   NTC 30k   Pt1000
Temperature	Defines the temperature. Displayed if <b>Temperature capture = Manual</b> or <b>Auto-Recognition</b> .	-30.0 °C...130.0 °C   -22.0 °F...266.0 °F
Sample ID	Defines the sample ID. Maximum 30 characters.	-
Auto sequential sample ID	Activates auto sequential sample ID. When using auto-sequential sample IDs, the instrument checks whether the last digits of a sample ID are numbers. If yes, the number is increased by 1 for the next measurement. If no, the number 1 is appended to the sample ID for the next measurement.  If this method is reloaded or the instrument is restarted, the sample ID will be reset to the one defined in the method.	Active   Inactive

### Conditioning

Parameter	Description	Values
Stir	<b>Active:</b> A stirring period is applied before the measurement and verification starts (after pressing <b>Read</b> ).	Active   Inactive
Stirring time	Defines the stir duration. Displayed if <b>Stir</b> is activated.	1...1000000 s
Stirring speed	Select the stir speed. Displayed if <b>Stir</b> is activated.	10%   20%   30%   40%   50%   60%   70%   80%   90%   100%
Wait	<b>Active:</b> Defines the wait time. The wait time is applied after the stirring period of the pre-conditioning, but before the measurement.	Active   Inactive 1...1000000 s
Use conditioning for calibration	<b>Active: Conditioning</b> settings are applied for each calibration point. Displayed if <b>Stir</b> or <b>Wait</b> is activated.	Active   Inactive

### Calibration

Parameter	Description	Values
Auto buffer recognition	<ul style="list-style-type: none"> <li>• <b>Active:</b> You can measure buffers in any order during calibration.</li> <li>• <b>Inactive:</b> You need to indicate the buffer order for each calibration point manually.</li> </ul>	Active   Inactive

Parameter	Description	Values
Buffer(s)	Select a buffer for each calibration point from the list. Up to 5 buffers can be defined. The selected buffer values cannot be the same.	-
Check buffer lot number	<b>Active:</b> You need to enter a buffer lot number manually before each calibration point.	Active   Inactive
Calibration mode	Select the calibration mode. <ul style="list-style-type: none"> <li><b>Linear:</b> The calibration curve is determined using linear regression.</li> <li><b>Segmented:</b> The calibration curve is made up of linear segments joining the individual calibration points.</li> </ul> If the number of the selected buffers is less than 3, the calibration mode can only be <b>Linear</b> . If high accuracy is required, <b>Segmented</b> is recommended.	Linear   Segmented
Stir	<b>Active:</b> A stirring period is applied during the calibration.	Active   Inactive
Stirring speed	Select the stir speed. Displayed if <b>Stir</b> is activated.	10%   20%   30%   40%   50%   60%   70%   80%   90%   100%
Calibration reminder	<b>Active:</b> The instrument checks the calibration expiry at regular intervals and takes action based on <b>Menu &gt; Settings &gt; Analysis settings &gt; Calibration expiry action</b> .	Active   Inactive 1...9999 Hour(s)   1...400 Day(s)

## Measure

Parameter	Description	Values
Unit	Select the unit of the measured value.	pH   mV
Decimal places	The values depend on the defined unit.	-
Endpoint type	Select the endpoint type. <ul style="list-style-type: none"> <li><b>Automatic:</b> The instrument determines when a measurement is to be stopped, based on the programmed stability criteria.</li> <li><b>Manual:</b> You need to stop the measurement manually.</li> <li><b>Timed:</b> The instrument stops the measurement after a defined time.</li> </ul>	Automatic   Manual   Timed
Endpoint time	Defines the time after which the instrument stops the measurement. Displays if <b>Endpoint type = Timed</b> .	1...1000000 s
Stability criteria	Select the stability criteria. See [Stability criteria ▶ Page 48] for details.	Strict   Standard   Fast
Stir	<b>Active:</b> A stirring is applied during the measurement and verification.	Active   Inactive
Stirring speed	Select the stir speed. Displayed if <b>Stir</b> is activated.	10%   20%   30%   40%   50%   60%   70%   80%   90%   100%
Limits	<b>Active:</b> The upper and lower limits for the measurement result can be defined.  If the measurement result is either less than the lower limit or more than the upper limit, a warning is displayed on the screen.	Active   Inactive

Lower limit	Defines the lower limit of the measurement result. The limit range is same as the measurement range. <ul style="list-style-type: none"> <li>• <b>Active:</b> The instrument will display a warning when the measurement result is less than the lower limit.</li> <li>• <b>Inactive:</b> The instrument will not display a warning because of the lower result limit.</li> </ul>	Active   Inactive
Upper limit	Defines the upper limit of the measurement result. The limit range is same as the measurement range. The upper limit value should be larger than lower limit value. <ul style="list-style-type: none"> <li>• <b>Active:</b> The instrument will display a warning when the measurement result is more than the upper limit.</li> <li>• <b>Inactive:</b> The instrument will not display a warning because of the upper result limit.</li> </ul>	Active   Inactive
Lower temp. limit	Defines the lower limit of the temperature. The limit range is same as the measurement range. <ul style="list-style-type: none"> <li>• <b>Active:</b> The instrument will display a warning if the measured temperature is less than the lower temperature limit.</li> <li>• <b>Inactive:</b> The instrument will not display a warning because of the lower temperature limit.</li> </ul>	Active   Inactive
Upper temp. limit	Defines the upper limit of the temperature. The limit range is same as the measurement range. The upper limit value should be larger than lower limit value. <ul style="list-style-type: none"> <li>• <b>Active:</b> The instrument will display a warning if the measured temperature is more than the upper temperature limit.</li> <li>• <b>Inactive:</b> The instrument will not display a warning because of the upper temperature limit.</li> </ul>	Active   Inactive
Interval reading	<b>Active:</b> The instrument records a measured value as a result at defined time intervals until the measurement is finished. Not recommended if <b>Endpoint type</b> is <b>Automatic</b> .	Active   Inactive
Interval time	Defines the time difference between two recorded measurement values for interval measurements. Displayed if <b>Interval reading</b> is activated.	1...1000000 s

## Verification

Parameter	Description	Values
Buffer(s)	Select a buffer from the list of defined buffers.	-
Verification criteria	Defines the verification criteria.	0.001...1.000 pH
Check buffer lot number	<b>Active:</b> You need to enter the lot number manually at the start of verification process.	Active   Inactive
Verification reminder	<b>Active:</b> The instrument checks the verification expiry at regular intervals and takes action based on <b>Menu &gt; Settings &gt; Analysis settings &gt; Verification expiry action</b> .	Active   Inactive 1...9999 Hour(s)   1...400 Day(s)

## Report

Parameter	Description	Values
Print format	Select the format of the report. <ul style="list-style-type: none"> <li>• <b>Short:</b> Prints a summary of the measurement result.</li> <li>• <b>Standard:</b> Prints full measurement results.</li> <li>• <b>GLP:</b> Prints detailed measurement result and method information.</li> </ul>	Short   Standard   GLP

## 7.7 Redox method parameters

### General

Parameter	Description	Values
Measurement type	Information on the measurement type.	Redox
Method ID	Defines the method name which uniquely identifies him to the system. Maximum 30 characters.	-
Author	Information on the administrator logged in at time of the method creation.	-
Created on	Information on date and time of the method creation.	-
Modified on	Information on date and time of the method modification.	-
Modified by	Information on the administrator logged in at time of the method modification.	-
Comment	Defines some comments. Maximum 128 characters.	-

### Configuration

Parameter	Description	Values
Sensor	Select a sensor from the list of defined sensors if the method always runs with the same sensor. <b>Any:</b> You can select any suitable sensor before calibration, verification or measurement.	Any   List of defined sensors
Temperature capture	Select the temperature capture mode. <ul style="list-style-type: none"> <li>• <b>Sensor:</b> Uses the temperature measured by a connected temperature sensor.</li> <li>• <b>Manual:</b> Uses your input temperature value.</li> <li>• <b>Auto-Recognition:</b> Uses automatic temperature correction if a temperature sensor is connected and manual temperature correction otherwise..</li> </ul>	Sensor   Manual   Auto-Recognition
Temperature	Defines the temperature. Displayed if <b>Temperature capture = Manual</b> or <b>Auto-Recognition</b> .	-30.0 °C...130.0 °C   -22.0 °F...266.0 °F
Sample ID	Defines the sample ID. Maximum 30 characters.	-

Auto sequential sample ID	Activates auto sequential sample ID. When using auto-sequential sample IDs, the instrument checks whether the last digits of a sample ID are numbers. If yes, the number is increased by 1 for the next measurement. If no, the number 1 is appended to the sample ID for the next measurement.  If this method is reloaded or the instrument is restarted, the sample ID will be reset to the one defined in the method.	Active   Inactive
---------------------------	---	-------------------

### Conditioning

Parameter	Description	Values
Stir	<b>Active:</b> A stirring period is applied before the measurement and verification starts (after pressing <b>Read</b> ).	Active   Inactive
Stirring time	Defines the stir duration. Displayed if <b>Stir</b> is activated.	1...1000000 s
Stirring speed	Select the stir speed. Displayed if <b>Stir</b> is activated.	10%   20%   30%   40%   50%   60%   70%   80%   90%   100%
Wait	<b>Active:</b> Defines the wait time. The wait time is applied after the stirring period of the pre-conditioning, but before the measurement.	Active   Inactive 1...1000000 s

### Measure

Parameter	Description	Values
Unit	Select the unit of the measured value.	mV   Rel.mV
Offset	Displayed if <b>Unit = Rel.mV</b> .	-2000.0...2000.0 mV
Decimal places	The values depend on the defined unit.	-
Endpoint type	Select the endpoint type. <ul style="list-style-type: none"> <li><b>Automatic:</b> The instrument determines when a measurement is to be stopped, based on the programmed stability criteria.</li> <li><b>Manual:</b> You need to stop the measurement manually.</li> <li><b>Timed:</b> The instrument stops the measurement after a defined time.</li> </ul>	Automatic   Manual   Timed
Endpoint time	Defines the time after which the instrument stops the measurement. Displays if <b>Endpoint type = Timed</b> .	1...1000000 s
Stability criteria	Select the stability criteria. See [Stability criteria ▶ Page 48] for details.	Strict   Standard   Fast
Stir	<b>Active:</b> A stirring is applied during the measurement and verification.	Active   Inactive
Stirring speed	Select the stir speed. Displayed if <b>Stir</b> is activated.	10%   20%   30%   40%   50%   60%   70%   80%   90%   100%
Limits	<b>Active:</b> The upper and lower limits for the measurement result can be defined.  If the measurement result is either less than the lower limit or more than the upper limit, a warning is displayed on the screen.	Active   Inactive

Lower limit	Defines the lower limit of the measurement result. The limit range is same as the measurement range. <ul style="list-style-type: none"> <li>• <b>Active:</b> The instrument will display a warning when the measurement result is less than the lower limit.</li> <li>• <b>Inactive:</b> The instrument will not display a warning because of the lower result limit.</li> </ul>	Active   Inactive
Upper limit	Defines the upper limit of the measurement result. The limit range is same as the measurement range. The upper limit value should be larger than lower limit value. <ul style="list-style-type: none"> <li>• <b>Active:</b> The instrument will display a warning when the measurement result is more than the upper limit.</li> <li>• <b>Inactive:</b> The instrument will not display a warning because of the upper result limit.</li> </ul>	Active   Inactive
Lower temp. limit	Defines the lower limit of the temperature. The limit range is same as the measurement range. <ul style="list-style-type: none"> <li>• <b>Active:</b> The instrument will display a warning if the measured temperature is less than the lower temperature limit.</li> <li>• <b>Inactive:</b> The instrument will not display a warning because of the lower temperature limit.</li> </ul>	Active   Inactive
Upper temp. limit	Defines the upper limit of the temperature. The limit range is same as the measurement range. The upper limit value should be larger than lower limit value. <ul style="list-style-type: none"> <li>• <b>Active:</b> The instrument will display a warning if the measured temperature is more than the upper temperature limit.</li> <li>• <b>Inactive:</b> The instrument will not display a warning because of the upper temperature limit.</li> </ul>	Active   Inactive
Interval reading	<b>Active:</b> The instrument records a measured value as a result at defined time intervals until the measurement is finished. Not recommended if <b>Endpoint type</b> is <b>Automatic</b> .	Active   Inactive
Interval time	Defines the time difference between two recorded measurement values for interval measurements. Displayed if <b>Interval reading</b> is activated.	1...1000000 s

### Verification

Parameter	Description	Values
Reference value	Defines the reference value.	-500...500 mV
Verification criteria	Defines the verification criteria.	-500...500 mV
Verification reminder	<b>Active:</b> The instrument checks the verification expiry at regular intervals and takes action based on <b>Menu &gt; Settings &gt; Analysis settings &gt; Verification expiry action</b> .	Active   Inactive 1...9999 Hour(s)   1...400 Day(s)

### Report

Parameter	Description	Values
Print format	Select the format of the report. <ul style="list-style-type: none"> <li>• <b>Short:</b> Prints a summary of the measurement result.</li> <li>• <b>Standard:</b> Prints full measurement results.</li> <li>• <b>GLP:</b> Prints detailed measurement result and method information.</li> </ul>	Short   Standard   GLP

## 7.8 Ion method parameters

### General

Parameter	Description	Values
Measurement type	Information on the measurement type.	Ion
Method ID	Defines the method name which uniquely identifies him to the system. Maximum 30 characters.	-
Author	Information on the administrator logged in at time of the method creation.	-
Created on	Information on date and time of the method creation.	-
Modified on	Information on date and time of the method modification.	-
Modified by	Information on the administrator logged in at time of the method modification.	-
Comment	Defines some comments. Maximum 128 characters.	-

### Configuration

Parameter	Description	Values
Sensor	Select a sensor from the list of defined sensors if the method always runs with the same sensor. <b>Any:</b> You can select any suitable sensor before calibration, verification or measurement.	Any   List of defined sensors
Temperature capture	Select the temperature capture mode. <ul style="list-style-type: none"> <li><b>Sensor:</b> Uses the temperature measured by a connected temperature sensor.</li> <li><b>Manual:</b> Uses your input temperature value.</li> <li><b>Auto-Recognition:</b> Uses automatic temperature correction if a temperature sensor is connected and manual temperature correction otherwise..</li> </ul>	Sensor   Manual   Auto-Recognition
Temperature	Defines the temperature. Displayed if <b>Temperature capture = Manual</b> or <b>Auto-Recognition</b> .	-30.0 °C...130.0 °C   -22.0 °F...266.0 °F
Sample ID	Defines the sample ID. Maximum 30 characters.	-
Auto sequential sample ID	Activates auto sequential sample ID. When using auto-sequential sample IDs, the instrument checks whether the last digits of a sample ID are numbers. If yes, the number is increased by 1 for the next measurement. If no, the number 1 is appended to the sample ID for the next measurement.  If this method is reloaded or the instrument is restarted, the sample ID will be reset to the one defined in the method.	Active   Inactive

### Conditioning

Parameter	Description	Values
Stir	<b>Active:</b> A stirring period is applied before the measurement and verification starts (after pressing <b>Read</b> ).	Active   Inactive
Stirring time	Defines the stir duration. Displayed if <b>Stir</b> is activated.	1...1000000 s

Parameter	Description	Values
Stirring speed	Select the stir speed. Displayed if <b>Stir</b> is activated.	10%   20%   30%   40%   50%   60%   70%   80%   90%   100%
Wait	<b>Active:</b> Defines the wait time. The wait time is applied after the stirring period of the pre-conditioning, but before the measurement.	Active   Inactive 1...1000000 s
Use conditioning for calibration	<b>Active: Conditioning</b> settings are applied for each calibration point. Displayed if <b>Stir</b> or <b>Wait</b> is activated.	Active   Inactive

### Calibration

Parameter	Description	Values
Standard(s)	Select a standard for each calibration point from the list. Up to 5 standards can be defined.	-
Check standard lot number	<b>Active:</b> You need to enter a standard lot number manually before each calibration point.	Active   Inactive
Calibration mode	Select the calibration mode. <ul style="list-style-type: none"> <li><b>Linear:</b> The calibration curve is determined using linear regression.</li> <li><b>Segmented:</b> The calibration curve is made up of linear segments joining the individual calibration points.</li> </ul> If the number of the selected buffers is less than 3, the calibration mode can only be <b>Linear</b> . If high accuracy is required, <b>Segmented</b> is recommended.	Linear   Segmented
Stir	<b>Active:</b> A stirring period is applied during the calibration.	Active   Inactive
Stirring speed	Select the stir speed. Displayed if <b>Stir</b> is activated.	10%   20%   30%   40%   50%   60%   70%   80%   90%   100%
Calibration reminder	<b>Active:</b> The instrument checks the calibration expiry at regular intervals and takes action based on <b>Menu &gt; Settings &gt; Analysis settings &gt; Calibration expiry action</b> .	Active   Inactive 1...9999 Hour(s)   1...400 Day(s)

### Measure

Parameter	Description	Values
Unit	Select the unit of the measured value.	pX   mg/L   mol/L   mmol/L   %   ppm   mV
Decimal places	The values depend on the defined unit. unit.	-
Endpoint type	Select the endpoint type. <ul style="list-style-type: none"> <li><b>Automatic:</b> The instrument determines when a measurement is to be stopped, based on the programmed stability criteria.</li> <li><b>Manual:</b> You need to stop the measurement manually.</li> <li><b>Timed:</b> The instrument stops the measurement after a defined time.</li> </ul>	Automatic   Manual   Timed
Endpoint time	Defines the time after which the instrument stops the measurement. Displays if <b>Endpoint type = Timed</b> .	1...1000000 s



Stability criteria	Select the stability criteria. See [Stability criteria ▶ Page 48] for details.	Strict   Standard   Fast
Stir	<b>Active:</b> A stirring is applied during the measurement and verification.	Active   Inactive
Stirring speed	Select the stir speed. Displayed if <b>Stir</b> is activated.	10%   20%   30%   40%   50%   60%   70%   80%   90%   100%
Limits	<b>Active:</b> The upper and lower limits for the measurement result can be defined.  If the measurement result is either less than the lower limit or more than the upper limit, a warning is displayed on the screen.	Active   Inactive
Lower limit	Defines the lower limit of the measurement result. The limit range is same as the measurement range. <ul style="list-style-type: none"> <li>• <b>Active:</b> The instrument will display a warning when the measurement result is less than the lower limit.</li> <li>• <b>Inactive:</b> The instrument will not display a warning because of the lower result limit.</li> </ul>	Active   Inactive
Upper limit	Defines the upper limit of the measurement result. The limit range is same as the measurement range. The upper limit value should be larger than lower limit value. <ul style="list-style-type: none"> <li>• <b>Active:</b> The instrument will display a warning when the measurement result is more than the upper limit.</li> <li>• <b>Inactive:</b> The instrument will not display a warning because of the upper result limit.</li> </ul>	Active   Inactive
Lower temp. limit	Defines the lower limit of the temperature. The limit range is same as the measurement range. <ul style="list-style-type: none"> <li>• <b>Active:</b> The instrument will display a warning if the measured temperature is less than the lower temperature limit.</li> <li>• <b>Inactive:</b> The instrument will not display a warning because of the lower temperature limit.</li> </ul>	Active   Inactive
Upper temp. limit	Defines the upper limit of the temperature. The limit range is same as the measurement range. The upper limit value should be larger than lower limit value. <ul style="list-style-type: none"> <li>• <b>Active:</b> The instrument will display a warning if the measured temperature is more than the upper temperature limit.</li> <li>• <b>Inactive:</b> The instrument will not display a warning because of the upper temperature limit.</li> </ul>	Active   Inactive
Interval reading	<b>Active:</b> The instrument records a measured value as a result at defined time intervals until the measurement is finished.  Not recommended if <b>Endpoint type</b> is <b>Automatic</b> .	Active   Inactive
Interval time	Defines the time difference between two recorded measurement values for interval measurements.  Displayed if <b>Interval reading</b> is activated.	1...1000000 s

### Verification

Parameter	Description	Values
Standard(s)	Select a standard from the list of defined standards.	-
Verification criteria	Defines the verification criteria.	0.1 %...30.0 %

Parameter	Description	Values
Check standard lot number	<b>Active:</b> You need to enter the lot number manually at the start of verification process.	Active   Inactive
Verification reminder	<b>Active:</b> The instrument checks the verification expiry at regular intervals and takes action based on <b>Menu &gt; Settings &gt; Analysis settings &gt; Verification expiry action.</b>	Active   Inactive 1...9999 Hour(s)   1...400 Day(s)

### Report

Parameter	Description	Values
Print format	Select the format of the report. <ul style="list-style-type: none"> <li><b>Short:</b> Prints a summary of the measurement result.</li> <li><b>Standard:</b> Prints full measurement results.</li> <li><b>GLP:</b> Prints detailed measurement result and method information.</li> </ul>	Short   Standard   GLP

## 7.9 Stability criteria

Measurement Type	Stability criteria		
	Strict	Standard	Fast
pH or Redox	Value varies less than 0.03 mV during the last 8 seconds or 0.1 mV for the last 20 seconds.	Value varies less than 0.1 mV during the last 6 seconds.	Value varies less than 0.6 mV during the last 4 seconds.
Ion	Value varies less than 0.03 mV for the last 8 seconds or 0.08 mV for the last 20 seconds.	Value varies less than 0.08 mV for the last 8 seconds.	Value varies less than 0.3 mV for the last 4 seconds.

## 8 Result

Navigation: Home screen > Results fly-in > List

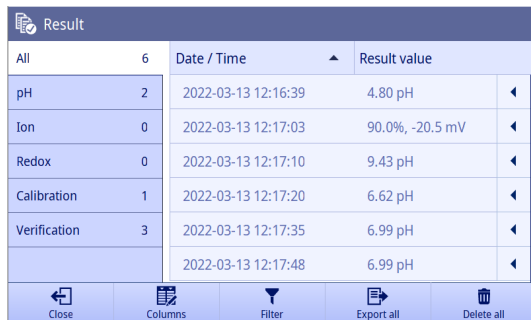

All	6	Date / Time	Result value
pH	2	2022-03-13 12:16:39	4.80 pH
Ion	0	2022-03-13 12:17:03	90.0%, -20.5 mV
Redox	0	2022-03-13 12:17:10	9.43 pH
Calibration	1	2022-03-13 12:17:20	6.62 pH
Verification	3	2022-03-13 12:17:35	6.99 pH
		2022-03-13 12:17:48	6.99 pH

Close Columns Filter Export all Delete all

The instrument can save up to 2000 standard results. If the maximum number of results is reached, older results are deleted. In case of large data sets, the total number of results may be reduced and multiple older results may be deleted. For safe long term data storage, it is recommended to maintain your data separately from the instrument, such as on printouts or by exporting to the EasyDirect™ pH PC software.

The results are divided into several categories by the tab in the left.

- **All**: show all results in a list, including the measurement, calibration and verification.
- **pH**: show pH measurement results in a list.
- **Redox**: show redox measurement results in a list.
- **Ion**: show ion measurement results in a list.
- **Calibration**: show calibration results in a list.
- **Verification**: show verification results in a list.

Two columns of result data are displayed in the result list. You can tap the name of the column to sort the results.

Tap the result row you can see the details of the result.

### Selecting data to display

You can select the following data to display in a result list:

- **Date / Time**: default
- **Method ID**
- **Sample ID**
- **Result value**: default
- **Result status**
- **User name**

To select the data to display, proceed as follows:

- Enter a result list category.
  - 1 Tap **Columns**.
  - 2 Use the drop down list to select which data to display in the first column.
  - 3 Use the drop down list to select which data to display in the second column.
  - 4 Confirm with **OK**.
- ⇒ Only the columns of the current result list changes.

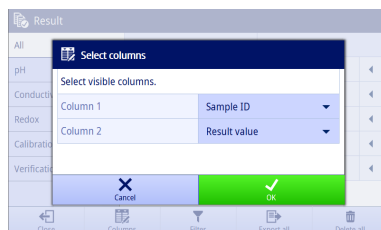

## Filtering results

To filter result, proceed as follows:

- Enter a result list category.
  - 1 Tap **Filter**.
  - 2 Enter the data you want to be filtered and confirm with **OK**.
    - OR -
  - 3 Tap **Clear filter** to show all results.

### Note

- You are only able to filter according to the visible columns in the result list.
- Column **Result value** cannot set filter.

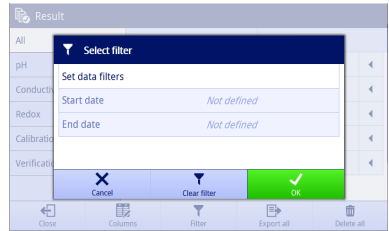

## Exporting a result

To export the result that you want to export, proceed as follows:

- Enter a result list category.
  - 1 Use the handle after the result that you want to export.
  - 2 Tap **More**.
    - OR -
  - 3 Tap the result that you want to export.
  - 4 Tap **Export**.

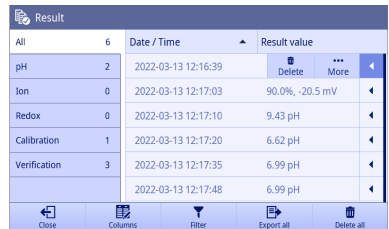

- 5 Select a device to export to.
  - 6 Confirm with **OK**.
- ➔ The result is stored in the device.

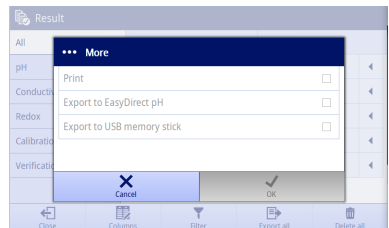

## Exporting all results

To export all results, proceed as follows:

- Enter a result list category.
  - 1 Tap **Export all** to export multiple results.

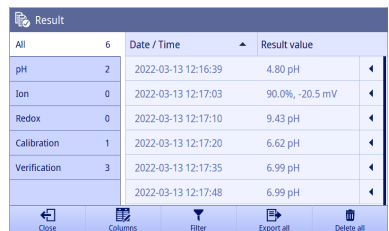

- 2 Select a device to export to.
  - 3 Confirm with **OK**.
- ➔ All results are stored in the device.

**Note** If tapped **Export all**, only the results displayed on the current result list can be export. For example, if you set a filter and then tap **Export all**, the results that are filtered out are not exported.

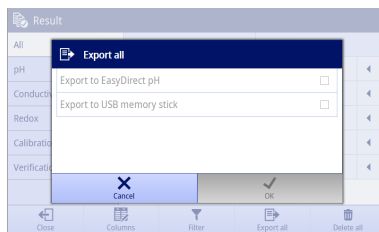

### Deleting a result

To delete a result that you want to delete, proceed as follows:

- Enter a result list category.
- 1 Use the handle after the result that you want to delete.
    - or -
  - 2 Tap the result that you want to delete.
  - 3 Tap **Delete**.

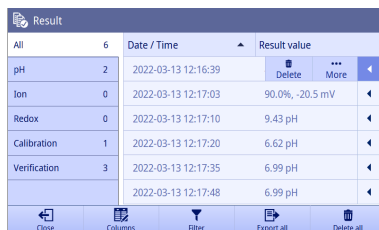

- 4 Confirm with **OK**.
- ➔ This result is removed from the result list category.

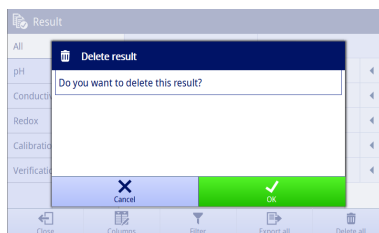

### Deleting all results

To delete all results, proceed as follows:

- Enter a result list category.
- 1 Tap **Delete all results** to delete multiple results.
  - 2 Confirm with **OK**.
- ➔ The result list category is empty.

**Note** If tapped **Delete all results**, only the results displayed on the current result list can be deleted. For example, if you set a filter and then tap **Delete all results** the results filtered out are not deleted.

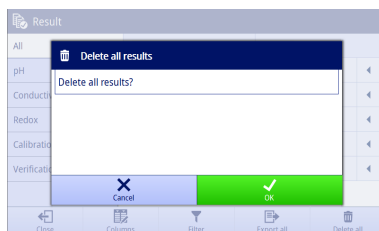

## Print a result

To print a result that you want to print, proceed as follows:

- 1 Use the handle after the result that you want to print.
- 2 Tap **More**.
- 3 Select **Print**.  
➔ A new line with **Format** pops up.
- 4 Select a format.
- 5 Confirm with **OK**.



All	6	Date / Time	Result value	
pH	2	2022-03-13 12:16:39		Delete More
Ion	0	2022-03-13 12:17:03	90.0%, -20.5 mV	
Redox	0	2022-03-13 12:17:10	9.43 pH	
Calibration	1	2022-03-13 12:17:20	6.62 pH	
Verification	3	2022-03-13 12:17:35	6.99 pH	
		2022-03-13 12:17:48	6.99 pH	

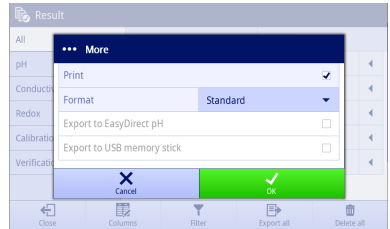

## 8.1 Results fly-in

The newest 7 results are displayed in **Results fly-in** sorted by date / time ascending, with the latest result at the top of the list.

There are 2 lines in a result. Tap a result and you can see the details about the result quickly.

	#	Description
	1	<ul style="list-style-type: none"> <li>For measurement               <ul style="list-style-type: none"> <li>Sample ID</li> <li>Time for today's results if no Sample ID is entered</li> <li>Date for old results if no Sample ID is entered</li> <li>"..." if the Sample ID is too long</li> </ul> </li> <li>For calibration               <ul style="list-style-type: none"> <li>pH calibration / cond. calibration / Ion calibration</li> </ul> </li> <li>For verification               <ul style="list-style-type: none"> <li>pH verification / cond. verification / Ion verification / redox verification</li> </ul> </li> </ul>
	2	The result of the measurement, calibration or verification. Only the result of the first segment is visible.
	3	The color bar changes if limits of measurement results are activated or for verification results. <ul style="list-style-type: none"> <li>Red               <ul style="list-style-type: none"> <li>Measurement value outside limits</li> <li>Verification value failed to fulfill criteria</li> </ul> </li> <li>Green               <ul style="list-style-type: none"> <li>Measurement value within limits</li> <li>Verification value fulfill criteria</li> </ul> </li> <li>Blue               <ul style="list-style-type: none"> <li>No limit is used for measurement</li> <li>All accepted calibration results are blue</li> </ul> </li> <li>Yellow               <ul style="list-style-type: none"> <li>Rejected calibration result</li> <li>Terminated measurement result</li> <li>Rejected verification result</li> </ul> </li> </ul> Rejection or termination of a calibration result takes precedence over the measurement limits. Therefore, yellow color will be shown instead of red or green if multiple options are applicable.

## 8.2 Result details

Different result types store different details. The main parts are as follows.

- Settings:** Displays the most important settings for the analysis.
- Data:** Displays the data of buffers/standards, stable status and time.
- Result:** Displays the result status and the information of analysis result.
- Resource:** Displays the information of the sensor.
- Interval:** Visible when the method uses **Interval reading**. Displays the list of each interval reading.
- Table:** Visible for calibration results. Displays the list of calibration points.

### 8.2.1 Result Reason & Result Status

If more than one status applies, the result shows the higher status level. Result status level (from low to high) is OK < OK\* < Failed < Error. If more than one error occurred, the instrument shows all of them as **Result reason**.

If none of the below criteria applies, the result status is 'OK'.

Result reason	Result Status		
	For measurement	For calibration	For verification
Calibration expired	OK*	-	OK*
Verification expired	OK*	-	-
No valid verification	OK*	-	-
Out of calibration range (pH only)	OK*	-	OK*
Out of measurement range	Failed	Failed	Failed
Out of measurement limits	Failed	-	-
Out of temperature limits	Failed	-	-
Slope out of range	-	Failed	-
Offset out of range	-	Failed	-
Terminated	Error	Error	Error
Sensor removed (ISM)	Error	Error	Error
Resource lost	Error	Error	Error
System problem	Error	Error	Error



## 9 Maintenance and Care

Do not open the housing of the instrument; it does not contain any parts that can be maintained, repaired or replaced by the user. If you experience problems with your instrument, contact your authorized METTLER TOLEDO dealer or service representative.

► [www.mt.com/contact](http://www.mt.com/contact)

**Note:** It is recommended to restart the instrument periodically for optimal performance.

### 9.1 Cleaning the Instrument



#### NOTICE

##### **Danger of damage to the instrument due to inappropriate cleaning agents!**

The housing is made of acrylonitrile butadiene styrene/polycarbonate (ABS/PC). This material is sensitive to some organic solvents, such as toluene, xylene and methyl ethyl ketone (MEK). If liquids enter the housing they can damage the instrument.

- 1 Use only water and a mild detergent to clean the housing.
- 2 Wipe off any spills immediately.

- The instrument is turned off and disconnected from the electrical outlet.
- Clean the housing of the instrument using a cloth dampened with water and a mild detergent.

If you have questions about the compatibility of cleaning agents, contact your authorized METTLER TOLEDO dealer or service representative.

► [www.mt.com/contact](http://www.mt.com/contact)

### 9.2 Maintenance of electrodes

The instrument monitors the condition of the attached pH electrodes.



Slope: 95-105%  
and offset:  $\pm$  (0-20) mV  
Electrode is in good condition



Slope: 90-94%  
or offset:  $\pm$  (20-35) mV  
Electrode needs cleaning



Slope: 85-89%  
or offset:  $\pm$  (>35) mV  
Electrode is defective or too old

When cleaning, always follow the instructions in the manual of the electrodes used. Make sure the pH electrode is always kept filled with the appropriate filling solution. For maximum accuracy, any filling solution that may have "crept" and encrusted the outside of the electrode should be removed with deionized water. Always store the electrode according to the manufacturer's instructions and do not allow it to dry out.

If the electrode slope falls rapidly, or if the response becomes sluggish, the following procedures may help. Try one of the following, depending on your sample.

Problem	Action
Fat or oil build-up	Either rinse the membrane with soap solution or acetone/ethanol or shortly soak the tip of the electrode in warm water. When rinsed with organic solvent, place the membrane overnight in 0.1 mol/L HCl.
pH electrode membrane has dried out	Soak the tip of the electrode overnight in 0.1 mol/L HCl. If this procedure has no effect, soak the tip of the electrode for a few minutes in reactivation solution for pH electrodes.
Protein build-up in the diaphragm of a pH electrode	Remove deposits by soaking the electrode in an HCl/pepsin solution for few hours or overnight.
Silver sulfide contamination of pH electrode	Remove deposits by soaking the electrode in a thiourea solution.

Run a new calibration after treatment.

**Note**

- Cleaning and filling solutions should be handled with the same care as that given to toxic or corrosive substances.

**9.3 Transporting the instrument**

Note the following instructions when transporting the instrument to a new location:

- Transport the instrument with care to avoid damage! The instrument may be damaged if not transported correctly.
- Unplug the instrument and remove all connected cables.
- Remove the electrode arm.
- To avoid damage to the instrument when transporting it over long distances, please use the original packaging.
- If the original packaging is no longer available, choose packaging that will ensure safe handling.

**9.4 Disposal**

In conformance with the European Directive 2012/19/EU on Waste Electrical and Electronic Equipment (WEEE) this device may not be disposed of in domestic waste. This also applies to countries outside the EU, per their specific requirements.

Please dispose of this product in accordance with local regulations at the collecting point specified for electrical and electronic equipment. If you have any questions, please contact the responsible authority or the distributor from which you purchased this device. Should this device be passed on to other parties, the content of this regulation must also be related.



## 10 Sensors, Solutions and Accessories

### pH Sensors

Parts	Order No.
<b>ISM® sensors with MultiPin™ head</b>	
InLab®Micro Pro-ISM, 3-in-1 pH sensor, glass shaft, 5 mm shaft diameter, ATC, refillable	51344163
InLab®Power Pro-ISM, 3-in-1 pH sensor, glass shaft, ATC, pressurized SteadyForce™ reference system	51344211
InLab®Pure Pro-ISM, 3-in-1 pH sensor, glass shaft, immovable glass sleeve, ATC, refillable	51344172
InLab®Routine Pro-ISM, 3-in-1 pH sensor, glass shaft, ATC, refillable	51344055
InLab®Science Pro-ISM, 3-in-1 pH sensor, glass shaft, movable glass sleeve, ATC, refillable	51344072
InLab®Solids Pro-ISM, 3-in-1 pH sensor, glass shaft, open junction, sharp membrane, ATC	51344155

### pH solutions

Solutions	Order No.
pH 2.00 buffer sachets, 30 x 20 mL	30111134
pH 2.00 buffer solution, 250 mL	51350002
pH 2.00 buffer solution, 6 x 250 mL	51350016
pH 4.01 buffer sachets, 30 x 20 mL	51302069
pH 4.01 buffer solution, 250 mL	51350004
pH 4.01 buffer solution, 6 x 250 mL	51350018
pH 7.00 buffer sachets, 30 x 20 mL	51302047
pH 7.00 buffer solution, 250 mL	51350006
pH 7.00 buffer solution, 6 x 250 mL	51350020
pH 9.21 buffer sachets, 30 x 20 mL	51302070
pH 9.21 buffer solution, 250 mL	51350008
pH 9.21 buffer solution, 6 x 250 mL	51350022
pH 10.01 buffer sachets, 30 x 20 mL	51302079
pH 10.00 buffer solution, 250 mL	51350010
pH 10.00 buffer solution, 6 x 250 mL	51350024
pH 11.00 buffer sachets, 30 x 20 mL	30111135
pH 11.00 buffer solution, 250 mL	51350012
pH 11.00 buffer solution, 6 x 250 mL	51350026
Rainbow sachets I (10 sachets of pH 4.01 / 7.00 / 9.21)	51302068
Rainbow sachets II (10 sachets of pH 4.01 / 7.00 / 10.01)	51302080
Rainbow bottles I (2 x 250 mL of pH 4.01 / 7.00 / 9.21)	30095312
Rainbow bottles II (2 x 250 mL of pH 4.01 / 7.00 / 10.00)	30095313
InLab storage solution (for all InLab pH and redox electrodes), 250 mL	30111142
Electrolyte 3 mol/L KCl, 25 mL	51343180
Electrolyte 3 mol/L KCl, 250 mL	51350072

Solutions	Order No.
Electrolyte 3 mol/L KCl, 6 x 250 mL	51350080
HCl/Pepsin solution (removes protein contamination), 250 mL	51350100
Thiourea solution (removes silver sulfide contamination), 250 mL	51350102
Regeneration solution for pH electrodes, 25 mL	51350104

### Conductivity sensors

Parts	Order No.
InLab®731-ISM	30014092
InLab®741-ISM (steel)	30014094
InLab®710 (glass)	51302256
InLab®720 (glass)	51302255
InLab®751-4mm (narrow shaft)	51344030

### Conductivity solutions

Parts	Order No.
10 µS/cm conductivity standard solution, 250 mL	51300169
84 µS/cm conductivity standard solution, 250 mL	51302153
84 µS/cm conductivity standard solution, 30 x 20 mL sachets	30111140
500 µS/cm conductivity standard solution, 250 mL	51300170
1413 µS/cm conductivity standard solution, 30 x 20 mL sachets	51302049
1413 µS/cm conductivity standard solution, 6 x 250 mL	51350096
12.88 mS/cm conductivity standard solution, 30 x 20 mL sachets	51302050
12.88 mS/cm conductivity standard solution, 6 x 250 mL	51350098

## 11 Technical Data

### General

<b>Screen</b>	Color TFT	
<b>Interfaces</b>	USB-A	USB-Stick (FAT12/FAT16/FAT32)/ Printer/barcode reader
	USB-B	Computer
<b>Ambient conditions</b>	Ambient temperature	5...40 °C
	Relative humidity	5...80% (non-condensing)
	Overvoltage category	Class II
	Pollution degree	2
	Range of application	For indoor use only
	Maximum operating altitude	Up to 5000 m
<b>Standards for safety and EMC</b>	See Declaration of Conformity	
<b>Dimensions</b>	Width	195 mm
	Depth	205 mm
	Height	65 mm
	Weight	850 g
<b>Power rating instrument</b>	Input voltage	12 V $\equiv$
	Maximum power consumption	15 W
<b>Power rating AC adapter</b>	Line voltage	100 - 240 V $\sim \pm 10$ %
	Input frequency	50/60 Hz
	Input current	0.5 A
	Output voltage	12 V $\equiv$
	Output current	1.5 A
<b>Materials</b>	Housing	ABS/PC reinforced
	Window	Glass

### pH measurement

<b>Measurement range</b>	pH	-2.000...20.000
	mV	-2000.0...2000.0
	Temperature	-30.0...130.0 °C
<b>Resolution</b>	pH	0.1/0.01/0.001
	mV	1/0.1
	Temperature	0.1 °C
<b>Accuracy</b>	pH	$\pm 0.002$
	mV	$\pm 0.1$ (-500.0...500.0 mV) $\pm 0.2$ (< -500.0 mV or > 500.0 mV)
	Temperature	$\pm 0.1$ °C (0.0...100.0 °C) $\pm 0.3$ °C (< 0.0 °C or > 100.0 °C)
<b>Isopotential point</b>	pH 7.00	
<b>pH input</b>	BNC, impedance > $3 \cdot 10^{12} \Omega$	

<b>Temperature input</b>	RCA (Cinch) NTC 30kΩ or PT1000	
<b>Calibration (pH)</b>	Calibration points	1...5
	Predefined buffer groups	11
	User-defined buffer groups	10
	Automatic buffer recognition	Yes
	Calibration methods	Linear, segmented

#### Ion measurement

<b>Measurement range</b>	mol/l	0...100
	mmol/l	0...100000
	mg/l, ppm	0...999999
	%	0.000...100.000
	pX	-2.000...20.000
	mV	-2000.0...2000.0 mV
	Temperature	-30.0...130.0 °C
<b>Resolution</b>	mmol/l, mg/l, ppm	0.1/0.01/0.001*
	mol/L	0.1/0.01/0.001/0.0001*
	%	0.1/0.01/0.001/0.0001
	pX	0.1/0.01/0.001/0.0001
	mV	1/0.1
	Temperature	0.1 °C
<b>Accuracy</b>	mmol/l, mol/l, mg/l, ppm, %	±0.5% of measured value
	pX	±0.002 pX
	mV	± 0.1 (-500...500 mV) ± 0.2 (< -500 mV or > 500 mV)
	Temperature	± 0.1 °C (0.0...100.0 °C) ± 0.3 °C (< 0.0 °C or > 100.0 °C)
<b>pX input</b>	BNC, impedance > 3 · 10 <sup>12</sup> Ω	
<b>Temperature input</b>	RCA (Cinch) NTC 30kΩ or PT1000	
<b>Calibration (Ion)</b>	Calibration points	1...5
	Predefined Ion standards	1
	User-defined Ion standards	10
	Calibration methods	Linear, segmented

\* For this parameter, resolution is automatically adjusted based on the measured value. A maximum of 6 digits is displayed.

## 12 Appendix

### 12.1 Predefined buffers

**Note:** If you intend to connect ISM sensors calibrated on SevenDirect to other meters, it is recommended to use the buffer groups MT USA, MT Europe or technical for traceability. Otherwise, the combined METTLER TOLEDO buffer group offers the greatest convenience.

#### METTLER TOLEDO (Ref. 25°C) USA & Europe & Technical

T [°C]	1.68	2.00	4.01	5.00	7.00	8.00	9.21	10.00	10.01	11.00
0.0	1.67	2.03	4.01	5.04	7.12	8.07	9.52	-	10.32	11.9
5.0	1.67	2.02	4.01	5.03	7.09	8.06	9.45	10.65	10.25	11.72
10.0	1.67	2.01	4.00	5.02	7.06	8.07	9.38	10.39	10.18	11.54
15.0	1.67	2.00	4.00	5.01	7.04	8.04	9.32	10.26	10.12	11.36
20.0	1.68	2.00	4.00	5.00	7.02	8.02	9.26	10.13	10.06	11.18
<b>25.0</b>	<b>1.68</b>	<b>2.00</b>	<b>4.01</b>	<b>5.00</b>	<b>7.00</b>	<b>8.00</b>	<b>9.21</b>	<b>10.00</b>	<b>10.01</b>	<b>11.00</b>
30.0	1.68	1.99	4.01	5.01	6.99	7.98	9.16	9.87	9.97	10.82
35.0	1.69	1.99	4.02	5.01	6.98	7.95	9.11	9.74	9.93	10.64
40.0	1.69	1.98	4.03	5.03	6.97	7.94	9.06	9.61	9.89	10.46
45.0	1.70	1.98	4.04	5.05	6.97	7.91	9.03	9.48	9.86	10.28
50.0	1.71	1.98	4.06	5.06	6.97	7.90	8.99	9.35	9.83	10.10
55.0	1.72	1.98	4.08	5.08	6.98	7.89	8.96	-	-	-
60.0	1.72	1.98	4.10	5.11	6.98	7.86	8.93	-	-	-
65.0	-	1.98	4.13	5.14	6.99	7.88	-	-	-	-
70.0	1.74	1.99	4.16	5.17	7.00	7.87	8.88	-	-	-
75.0	-	1.99	4.19	5.20	7.02	7.86	-	-	-	-
80.0	1.77	2.00	4.22	5.23	7.04	7.85	8.83	-	-	-
85.0	-	2.00	4.26	5.26	7.06	7.86	-	-	-	-
90.0	1.79	2.00	4.30	5.29	7.09	7.87	8.79	-	-	-
95.0	1.81	2.00	4.35	5.32	7.12	7.87	8.77	-	-	-

**DIN(19266)/NIST (Ref. 25°C)**

<b>T [°C]</b>	<b>1.679</b>	<b>3.557</b>	<b>3.776</b>	<b>4.005</b>	<b>6.865</b>	<b>7.413</b>	<b>9.180</b>	<b>10.012</b>	<b>12.454</b>
0.0	1.666	-	3.865	4.000	6.984	7.534	9.464	10.317	-
5.0	1.668	-	3.840	3.998	6.951	7.500	9.395	10.245	13.207
10.0	1.670	-	3.820	3.997	6.923	7.472	9.332	10.179	13.003
15.0	1.672	-	3.802	3.998	6.900	7.448	9.276	10.118	12.810
20.0	1.675	-	3.788	4.000	6.881	7.429	9.225	10.062	12.627
<b>25.0</b>	<b>1.679</b>	<b>3.557</b>	<b>3.776</b>	<b>4.005</b>	<b>6.865</b>	<b>7.413</b>	<b>9.180</b>	<b>10.012</b>	<b>12.454</b>
30.0	1.683	3.552	3.766	4.011	6.853	7.400	9.139	9.966	12.289
35.0	1.688	3.549	3.759	4.018	6.844	7.389	9.102	9.926	12.133
37.0	-	3.548	3.756	4.022	6.841	7.386	9.088	9.910	-
38.0	1.691	-	-	-	-	-	-	-	12.043
40.0	1.694	3.547	3.754	4.027	6.838	7.380	9.068	9.889	11.984
45.0	-	-	-	-	-	-	-	-	11.841
50.0	1.707	3.549	3.749	4.050	6.833	7.367	9.011	9.828	11.705

**JJG119 (Chinese) (Ref. 25°C)**

<b>T [°C]</b>	<b>1.680</b>	<b>3.559</b>	<b>3.776</b>	<b>4.003</b>	<b>6.864</b>	<b>7.413</b>	<b>7.699</b>	<b>9.182</b>	<b>10.012</b>	<b>12.460</b>
0.0	1.668	-	3.863	4.006	6.981	7.534	8.471	9.458	10.317	13.416
5.0	1.669	-	3.840	3.999	6.949	7.500	8.303	9.391	10.245	13.210
10.0	1.671	-	3.820	3.996	6.921	7.472	8.142	9.330	10.179	13.011
15.0	1.673	-	3.802	3.996	6.898	7.448	7.988	9.276	10.118	12.820
20.0	1.676	-	3.788	3.998	6.879	7.429	7.840	9.226	10.062	12.637
<b>25.0</b>	<b>1.680</b>	<b>3.559</b>	<b>3.776</b>	<b>4.003</b>	<b>6.864</b>	<b>7.413</b>	<b>7.699</b>	<b>9.182</b>	<b>10.012</b>	<b>12.460</b>
30.0	1.684	3.551	3.766	4.010	6.852	7.400	7.563	9.142	9.966	12.292
35.0	1.688	3.547	3.759	4.019	6.844	7.389	7.433	9.105	9.926	12.130
37.0	1.694	3.547	3.756	4.022	6.839	7.386	7.382	-	9.910	12.069
40.0	1.694	3.547	3.754	4.029	6.838	7.380	7.307	9.072	9.889	11.975
45.0	1.700	3.550	-	4.042	6.834	-	7.186	9.042	-	11.828
50.0	1.706	3.555	3.749	4.055	6.833	7.367	7.070	9.015	9.828	11.697
55.0	1.713	3.563	-	4.070	6.834	-	-	8.990	-	11.553
60.0	1.721	3.573	-	4.087	6.837	-	-	8.968	-	11.426
70.0	1.739	3.596	-	4.122	6.847	-	-	8.926	-	-
80.0	1.759	3.622	-	4.161	6.862	-	-	8.890	-	-
90.0	1.782	3.648	-	4.203	6.881	-	-	8.856	-	-
95.0	1.795	3.660	-	4.224	6.891	-	-	8.839	-	-



**MERCK (Ref. 20°C)**

<b>T [°C]</b>	<b>2.00</b>	<b>4.00</b>	<b>7.00</b>	<b>9.00</b>	<b>12.00</b>
5.0	2.01	4.05	7.07	9.16	12.41
10.0	2.01	4.03	7.05	9.11	12.26
15.0	2.00	4.02	7.02	9.05	12.10
<b>20.0</b>	<b>2.00</b>	<b>4.00</b>	<b>7.00</b>	<b>9.00</b>	<b>12.00</b>
25.0	2.00	3.99	6.98	8.95	11.88
30.0	2.00	3.98	6.98	8.91	11.72
35.0	2.00	3.98	6.96	8.88	11.67
40.0	2.00	3.98	6.95	8.85	11.54
45.0	2.00	3.98	6.95	8.82	11.44
50.0	2.00	3.98	6.95	8.79	11.33

**DIN(19267) (Ref. 25°C)**

<b>T [°C]</b>	<b>1.09</b>	<b>3.06</b>	<b>4.65</b>	<b>6.79</b>	<b>9.23</b>	<b>12.75</b>
0.0	1.08	-	4.67	6.89	9.48	-
10.0	1.09	3.10	4.66	6.84	9.37	13.37
20.0	1.09	3.07	4.65	6.80	9.27	12.96
<b>25.0</b>	<b>1.09</b>	<b>3.06</b>	<b>4.65</b>	<b>6.79</b>	<b>9.23</b>	<b>12.75</b>
30.0	1.10	3.05	4.65	6.78	9.18	12.61
40.0	1.10	3.04	4.66	6.76	9.09	12.29
50.0	1.11	3.04	4.68	6.76	9.00	11.98
60.0	1.11	3.04	4.70	6.76	8.92	11.69
70.0	1.11	3.04	4.72	6.76	8.88	11.43
80.0	1.12	3.05	4.75	6.78	8.85	11.19
90.0	1.13	3.07	4.79	6.80	8.82	10.99

**GB/T(27501) (Ref. 25°C)**

<b>T [°C]</b>	<b>1.680</b>	<b>3.559</b>	<b>4.003</b>	<b>6.864</b>	<b>9.182</b>	<b>12.460</b>
0.0	1.668	-	4.006	6.981	9.458	13.416
5.0	1.669	-	3.999	6.949	9.391	13.210
10.0	1.671	-	3.996	6.921	9.330	13.011
15.0	1.673	-	3.996	6.898	9.276	12.820
20.0	1.676	-	3.998	6.879	9.226	12.637
<b>25.0</b>	<b>1.680</b>	<b>3.559</b>	<b>4.003</b>	<b>6.864</b>	<b>9.182</b>	<b>12.460</b>
30.0	1.684	3.551	4.010	6.852	9.142	12.292
35.0	1.688	3.547	4.019	6.844	9.105	12.130
40.0	1.694	3.547	4.029	6.838	9.072	11.975
45.0	1.700	3.550	4.042	6.834	9.042	11.828
50.0	1.706	3.555	4.055	6.833	9.015	11.697
55.0	1.713	3.563	4.070	6.834	8.990	11.553
60.0	1.721	3.573	4.087	6.837	8.968	11.426
70.0	1.739	3.596	4.122	6.847	8.926	-
80.0	1.759	3.622	4.161	6.862	8.890	-
90.0	1.782	3.648	4.203	6.881	8.856	-
95.0	1.795	3.660	4.224	6.891	8.839	-

**JISZ882(Japanese)**

<b>T [°C]</b>	<b>1.679</b>	<b>4.008</b>	<b>6.865</b>	<b>9.180</b>
5.0	1.668	3.999	6.951	9.395
10.0	1.670	3.998	6.923	9.332
15.0	1.672	3.999	6.900	9.276
20.0	1.675	4.002	6.881	9.225
<b>25.0</b>	<b>1.679</b>	<b>4.008</b>	<b>6.865</b>	<b>9.180</b>
30.0	1.683	4.015	6.853	9.139
35.0	1.688	4.024	6.844	9.102
40.0	1.694	4.035	6.838	9.068
45.0	1.700	4.047	6.834	9.038
50.0	1.707	4.060	6.833	9.011

**ChP 2020 (Ref. 25°C)**

<b>T [°C]</b>	<b>1.68</b>	<b>4.01</b>	<b>6.68</b>	<b>9.18</b>	<b>12.45</b>
0.0	1.67	4.01	6.98	9.46	13.43
5.0	1.67	4.00	6.95	9.40	13.21
10.0	1.67	4.00	6.92	9.33	13.00
15.0	1.67	4.00	6.90	9.27	12.81
20.0	1.68	4.00	6.88	9.22	12.63
<b>25.0</b>	<b>1.68</b>	<b>4.01</b>	<b>6.68</b>	<b>9.18</b>	<b>12.45</b>
30.0	1.68	4.01	6.85	9.14	12.30
35.0	1.69	4.02	6.84	9.10	12.14
40.0	1.69	4.04	6.84	9.06	11.98
45.0	1.70	4.05	6.83	9.04	11.84
50.0	1.71	4.06	6.83	9.01	11.71
55.0	1.72	4.08	6.83	8.99	11.57
60.0	1.72	4.09	6.84	8.96	11.45

**12.2 Predefined standards****International**

<b>T [°C]</b>	<b>10 µS/cm</b>	<b>84 µS/cm</b>	<b>500 µS/cm</b>	<b>1413 µS/cm</b>	<b>12.88 mS/cm</b>
5.0	6.13	53.02	315.3	896	8.22
10.0	7.10	60.34	359.6	1020	9.33
15.0	7.95	67.61	402.9	1147	10.48
16.0	8.15	69.25	-	-	-
17.0	8.36	70.89	-	-	-
18.0	8.56	72.52	-	-	-
19.0	8.77	74.16	-	-	-
20.0	8.97	75.80	451.5	1278	11.67
21.0	9.18	77.44	-	-	-
22.0	9.38	79.08	-	-	-
23.0	9.59	80.72	-	-	-
24.0	9.79	82.36	-	-	-
<b>25.0</b>	<b>10.00</b>	<b>84.00</b>	<b>500.0</b>	<b>1413</b>	<b>12.88</b>
30.0	11.03	92.19	548.5	1552	14.12
35.0	12.14	100.92	602.5	1696	15.39
40.0	13.29	109.21	-	-	-
45.0	14.44	118.05	-	-	-
50.0	15.55	126.80	-	-	-

**Chinese**

T [°C]	146.5 µS/cm	1408 µS/cm	12.85 mS/cm	111.3 mS/cm
15.0	118.5	1141.4	10.455	92.12
18.0	126.7	1220.0	11.163	97.80
20.0	132.2	1273.7	11.644	101.70
<b>25.0</b>	<b>146.5</b>	<b>1408.3</b>	<b>12.852</b>	<b>111.31</b>
35.0	176.5	1687.6	15.353	131.10

**Japanese Standards**

T [°C]	1330 µS/cm	133.0 µS/cm	26.6 µS/cm
0.0	771.40	77.14	15.428
5.0	911.05	91.11	18.221
10.0	1050.70	105.07	21.014
15.0	1190.35	119.04	23.807
<b>20.0</b>	<b>1330.00</b>	<b>133.00</b>	<b>26.600</b>
25.0	1469.65	146.97	29.393
30.0	1609.30	160.93	32.186
35.0	1748.95	174.90	34.979

**Saturated NaCl**

T [°C]	251.3 mS/cm
5.0	155.5
10.0	177.9
15.0	201.5
20.0	226.0
<b>25.0</b>	<b>251.3</b>
30.0	277.4
35.0	304.1

**METTLER TOLEDO ION**

T [°C]	0.1 mg/L	1 mg/L	10 mg/L	100 mg/L	1000 mg/L
20.0	0.1	1	10	100	1000
25.0	0.1	1	10	100	1000
30.0	0.1	1	10	100	1000



## **To protect your product's future:**

METTLER TOLEDO Service assures the quality, measuring accuracy and preservation of value of this product for years to come.

Please request full details about our attractive terms of service.

[www.mt.com/pHLab](http://www.mt.com/pHLab)

For more information

### **Mettler-Toledo GmbH**

Im Langacher 44  
8606 Greifensee, Switzerland  
Tel. +41 22 567 53 22  
Fax +41 22 567 53 23  
[www.mt.com](http://www.mt.com)

Subject to technical changes.  
© Mettler-Toledo GmbH 03/2022  
30657117A



30657117