

BROOKFIELD AMETEK DVE
Digital Viscometer

Operating Instructions

Manual No. **M15-356-A0316**



Instrumentation & Specialty Controls Division

11 Commerce Boulevard, Middleboro, MA 02302 USA
Tel: 508-946-6200 or 800-628-8139 (USA excluding MA)
Fax: 508-946-6262 Internet <http://www.brookfieldengineering.com>

TABLE OF CONTENTS

I. INTRODUCTION	5
I.1 Components	6
I.2 Utilities	6
I.3 Components and Dimensions.....	7
I.4 Specifications.....	9
I.5 Installation	10
I.6 Safety Symbols and Precautions	12
I.7 Key Functions.....	12
I.8 Preventative Maintenance and Cleaning.....	13
II. GETTING STARTED	14
II.1 Power Up	14
II.2 Options	14
II.3 Spindle Selection	15
II.4 Speed Selection	15
II.5 Viscosity Units.....	15
II.6 Range.....	18
II.7 Out of Range.....	19
III. Making Viscosity Measurements	21
III.1 Quick Start	21
III.2 Preparation for Making Measurements.....	21
III.3 Selecting a Spindle/Speed	22
III.4 Running a Test.....	22
Appendix A - Viscosity Ranges	24
Appendix B - Variables in Viscosity Measurements	28
Appendix C - Spindle Entry Codes and SMC/SRC Values	30
Appendix D - Spindle Entry Codes and Range Coefficients	33
Appendix E - Calibration Check Procedures	35
Appendix F - The Brookfield AMETEK Guard Leg	42
Appendix G - Laboratory Stands with Parts Identification	44
Appendix H - Fault Diagnosis and Troubleshooting	46
Appendix I - Online Help and Additional Resources	47
Appendix J - Warranty Repair and Services	48
Viscosity Test Report.....	(tear out page)

I. INTRODUCTION

The Brookfield AMETEK **DVE** Viscometer measures fluid viscosity at given shear rates. Viscosity is a measure of a fluid's resistance to flow. You will find a detailed description of the mathematics of viscosity in the Brookfield AMETEK publication "More Solutions to Sticky Problems", a copy of which was included with your **DVE** and can be downloaded in pdf form from the Brookfield AMETEK website, www.brookfieldengineering.com.

The principle of operation of the **DVE** is to rotate a spindle (which is immersed in the test fluid) through a calibrated spring. The viscous drag of the fluid against the spindle is measured by the spring deflection. Spring deflection is determined optically by measuring the shift in the spindle position due to the viscous drag of the fluid against the spindle. The measurement range of a **DVE** (in Poise, centiPoise, Pascal or milliPascal seconds) is determined by the rotational speed of the spindle, the size and shape of the spindle, the container in which the spindle is rotating, and the full scale torque of the calibrated spring.

There are four basic spring torque series offered by Brookfield AMETEK:

<u>Model</u>	<u>Spring Torque</u>	
	<u>dyne-cm</u>	<u>milli Newton-m</u>
DVELV	673.7	0.0673
DVERV	7,187.0	0.7187
DVEHA	14,374.0	1.4374
DVEHB	57,496.0	5.7496

The higher the spring torque, the higher the measurement range. The viscosity measurement range for each spring torque may be found in **Appendix A**.

All units of measurement are displayed according to either the CGS (cP) system or the SI (mPa•s) system.

1. Viscosity appears in units of Poise (shown as "P"), centipoise (shown as "cP"), Pascal Seconds (shown as "Pa•S") or milliPascal-seconds (shown as "mPa•s") on the **DVE** display.
2. Torque appears in units of dyne-centimeters or Newton-meters (shown as percent "%" in both cases) on the **DVE** display.

The equivalent units of measurement in the SI system are calculated using the following conversions:

Viscosity:	<u>SI</u>	=	<u>CGS</u>
	1 mPa•s	=	1 cP
Torque:	1 Newton-m	=	10 ⁷ dyne-cm
			1 Pa•S = 10 P

References to viscosity throughout this manual are made in CGS units. The **DVE** Viscometer provides equivalent information in SI units (see Section II.5: Viscosity Units).

I.1 Components

Please check to be sure that you have received all components, and that there is no damage. If you are missing any parts, please notify Brookfield AMETEK or your local Brookfield AMETEK agent immediately. Any shipping damage must be reported to the carrier.

COMPONENT	PART NUMBER	QUANTITY
DVE	varies	1
Model A Laboratory Stand	Model A	1
Spindle Set with Case	varies	1
DVELV set of four spindles (#61 through #64)	SSL	
DVERV set of six spindles (#02 through #07)	SSR	
DVEHA/DVEHB set of six spindles (#02 through #07)	SSH	
Shipping Cap	B-30-3Y	1
Power Supply	AV-6	1
Power Cord (115V/230V)	varies	
Guard leg (not supplied with HA/HB versions)	varies	1
DVELV	B-20Y	
DVERV	B-21Y	
Carrying Case	DV-3401	1
Operating Instructions	M15-356	1

I.2 Utilities

VAC; Hz Limits: 100 - 240 VAC; 50/60 Hz \pm 5%

Power Supply: 15 Watts, Class II certified plug-in power supply rated: 12 V @ 1.25A

 Main supply voltage fluctuations are not to exceed 10% of the nominal supply voltage.

 Must be used with AV-6 Power Supply. Alternative power sources may cause damage to the instrument.

I.3 Components and Dimensions

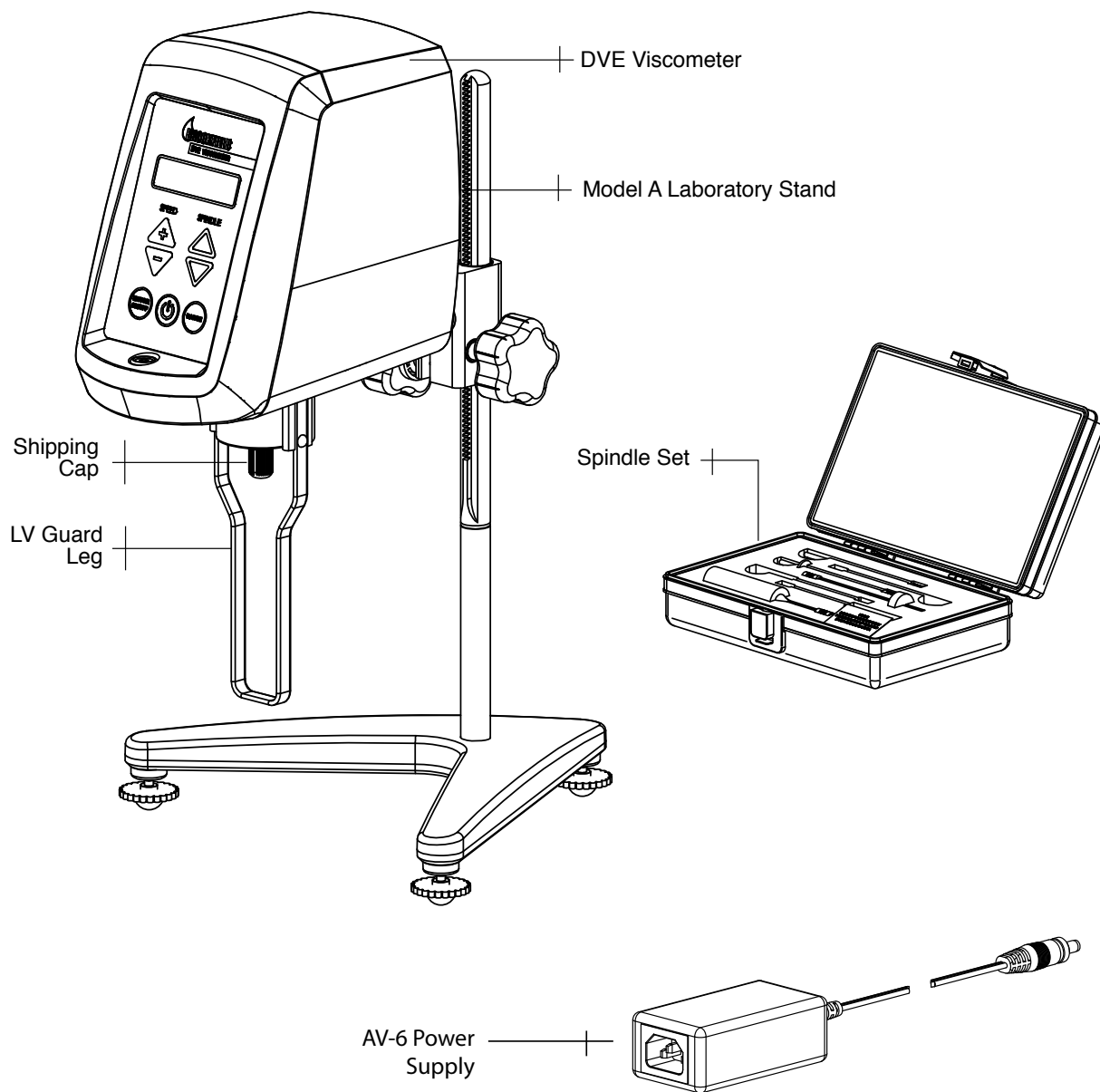

Figure I-1

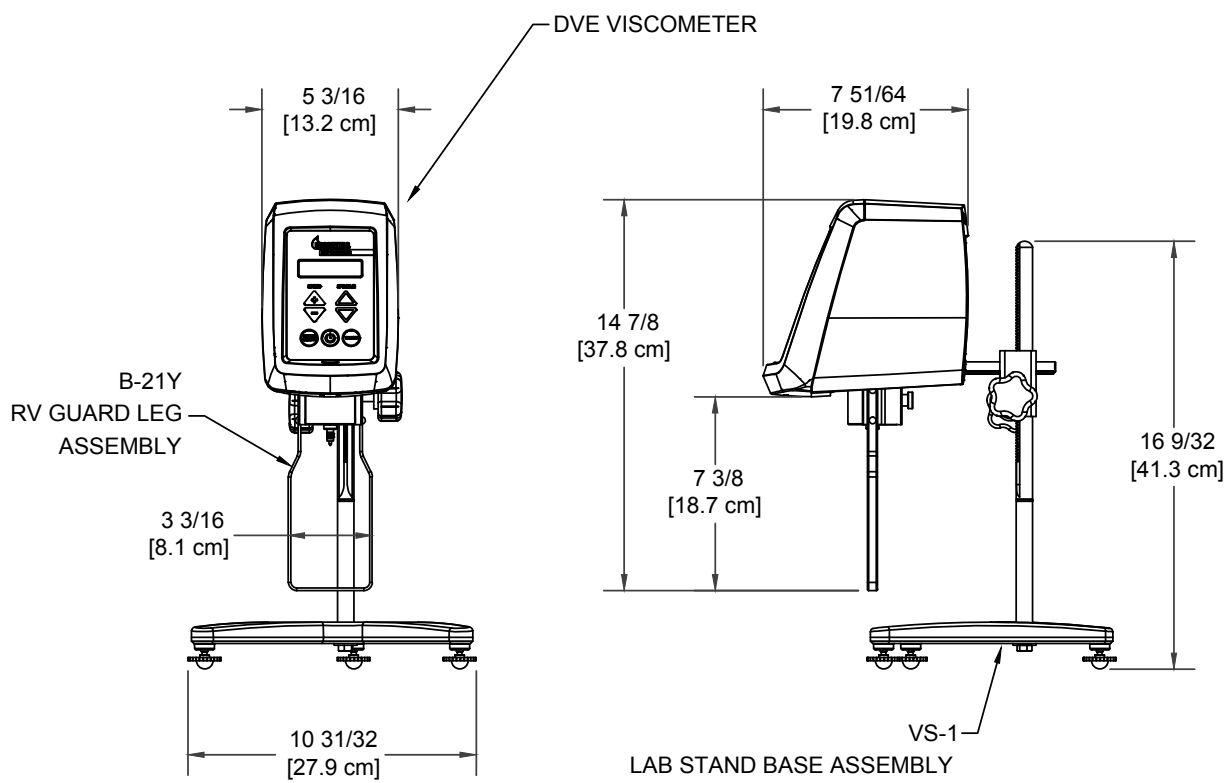
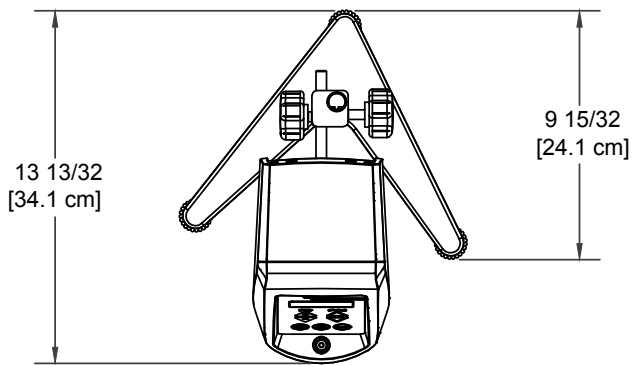

Figure I-2

I.4 Specifications

Speeds: 0.3, 0.5, 0.6, 1.0, 1.5, 2.0, 2.5, 3.0, 4.0, 5.0, 6.0, 10, 12, 20, 30, 50, 60, 100 RPM

Weight:	Gross Weight	24 lb	10.9 kg
	Net Weight	21 lb	9.5 kg
	Carton Volume	2.48 cu ft	0.07 m ³
	Carton Dimension	21 x 12 x 17 in	53 x 30 x 43 cm

Operating Environment: 0°C to 40°C Temperature Range (32°F to 104°F) (Ensure the instrument temperature does not exceed 40°C when positioned above a Temperature Bath operating at elevated temperatures.)
20% - 80% R.H.: non-condensing atmosphere

Viscosity Accuracy: ±1.0% Full Scale Range in Use (see **Appendix E** for details)

Viscosity Reproducibility: 0.2% of Full Scale Range

Ingress Protection Rating: IP30*

Electrical Certifications:

Conforms to CE Standards:

BSEN 61326: Electrical equipment for measurement, control and laboratory use - EMC requirements.

BSEN 61010-1: Safety requirements for electrical equipment, for measurement, control and laboratory use.

NOTICE TO CUSTOMERS:



This symbol indicates that this product is to be recycled at an appropriate collection center.

Users within the European Union:

Please contact your dealer or the local authorities in charge of waste management on how to dispose of this product properly. All Brookfield AMETEK offices and our network of representatives and dealers can be found on our website: www.brookfieldengineering.com.

Users outside of the European Union:

Please dispose of this product according to your local laws.

* when used with any of the following accessories: Thermosel, Small Sample Adapter, UL Adapter, DIN Adapter, Spiral Adapter, LV Spindle Guard Leg or RV Spindle Guard Leg. Otherwise, ingress protection rating is IP20.

I.5 Installation

Note: “IQ, OQ, PQ”, an abbreviated guideline document for installation, operation and performance validation for your DVE digital viscometer can be downloaded from our website www.brookfieldengineering.com. A more detailed IQ,OQ,PQ procedure is available for purchase from Brookfield AMETEK or your authorized dealer.

1. To assemble the Model A Laboratory Stand, place the upright rod into the base on a clean, dry and vibration-free surface (refer to assembly instructions in **Appendix G**).
2. Insert the mounting rod on the back of the **DVE** Viscometer into the hole on the clamp assembly (refer to **Appendix G**). Center the bubble level from left to right before tightening the clamp.
3. The Viscometer must be leveled. The level is adjusted using the three leveling screws on the base. Adjust so that the bubble level on the front of the **DVE** is centered within the circle.

Note: Check level periodically during use.

4. Remove the shipping cap from the pivot cup. This cap is designed to protect the Viscometer spindle coupling nut during shipment. **Do not attempt to operate the Viscometer with the shipping cap in place!** Save this cap for future use.
5. Plug the metal jack of the power supply into the circular receptacle on the back of the Viscometer. Screw the threaded collar on the metal jack securely to the threads of the receptacle. Connect the power cord to the socket on the power supply and plug it into the appropriate power source. (Refer to Figure I-3.)
6. Optional: Install the screen protector (Part No. DV-1404) per the instructions on the package. Additional installation help can also be found on our YouTube channel: www.youtube.com/user/BrookfieldEng



Note: Must be used with the AV-6 power supply. Alternative power sources may cause damage to the instrument electronics.



Note: The AV-6 must be earth grounded to maintain compliance with electrical certifications.



Note: The AC input voltage and frequency must be within the appropriate range as shown on the nameplate of the power supply (see Section I.2).

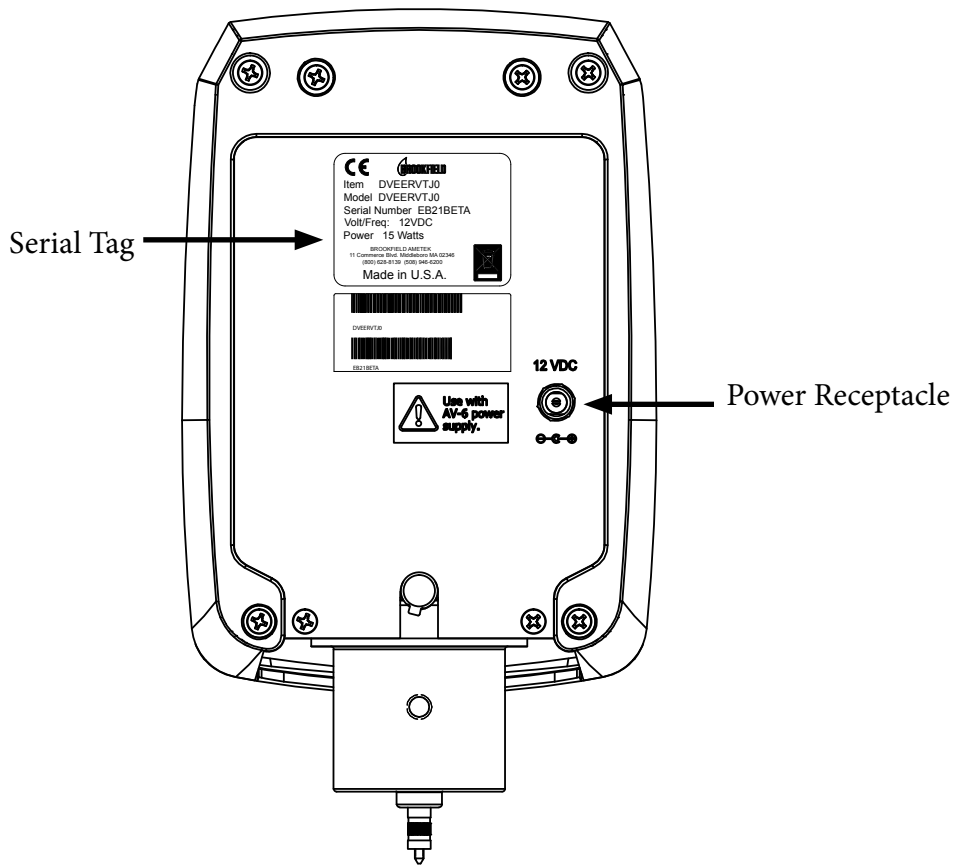
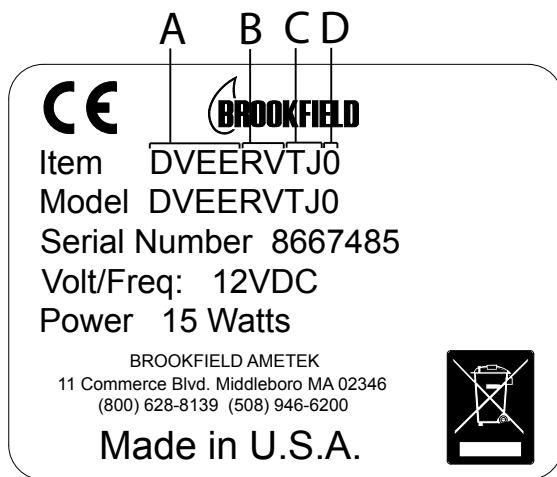

Figure I-3

The instrument can be identified by the item or model number. The item and model numbers appear on the Serial tag located at the back of the instrument. Below is an explanation on how to read these numbers.





- A - DVE Designation
- B - Torque Range (LV, RV, HA, HB)
- C - T: Standard Thread Coupling
J: Point/Jewel Suspension
- D - Unused





1.6 Safety Symbols and Precautions

Safety Symbols

The following explains safety symbols, which may be found in this operating manual.



-  Indicates hazardous voltages may be present.
-  Refer to the manual for specific warning or caution information to avoid personal injury or damage to the instrument.

Precautions

-  If this instrument is used in a manner not specified by the manufacturer, the protection provided by the instrument may be impaired.
-  This instrument is not intended for use in a potentially hazardous environment.
-  In case of emergency, turn off the instrument and then disconnect the electrical cord from the wall outlet.
-  The user should ensure that the substances placed under test do not release poisonous, toxic or flammable gases at the temperatures to which they are subjected to during the testing.

1.7 Key Functions

Figure 1-4 shows the control keys on the face of the DVE Viscometer. Each key's function is described below. For additional navigation instructions, see Section 11.2.

-  **POWER KEY**
Switches instrument between on and standby.
-  **MOTOR ON/OFF**
Turns the motor on or off, starts or stops spindle rotation and starts or stops current test.
-  **RANGE**
Presents the maximum (100% torque) viscosity attainable (known as Full Scale Range) for the spindle/speed selected. Viscometer accuracy is $\pm 1\%$ of the maximum (100% torque) viscosity value; minimum recommended viscosity range is 10% of the maximum viscosity value.

Note: Range was called Autorange on previous versions of Brookfield AMETEK Viscometers.

In the *Options* screen, the **RANGE** key selects the currently displayed option or viscosity unit and/or exits the *Options* screen.

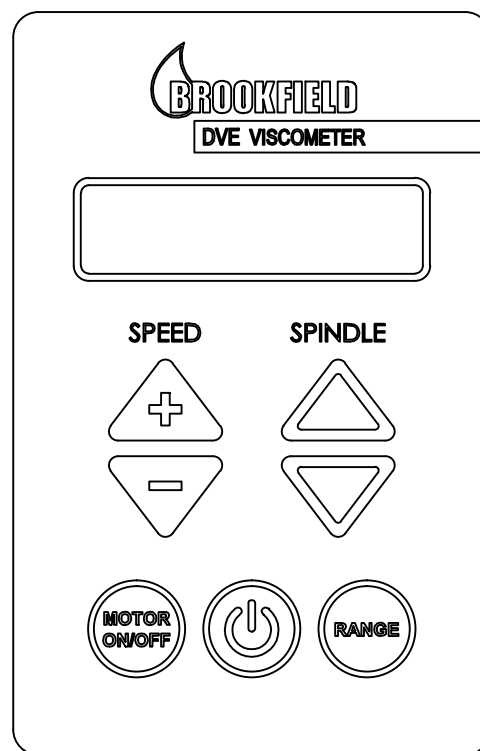

Figure 1-4

**SPEED +**

Used to scroll UP (in an increasing value direction) through the available speed tables.

**SPEED -**

Used to scroll DOWN (in a decreasing value direction) through the available speed tables.

**SPINDLE (UP)**

Used to scroll UP (in an increasing value direction) through the available spindle tables. In the *Options* screen, used to scroll UP through available options and viscosity units.

**SPINDLE (DOWN)**

Used to scroll DOWN (in a decreasing value direction) through the available spindle tables. In the *Options* screen, used to scroll DOWN through available options and viscosity units.

1.8 Preventative Maintenance and Cleaning



Make sure the instrument is in a clean, dry working environment (dust-free, moderate temperature, low humidity, etc.).



Make sure the instrument is on a level surface.



Hands/fingers must be clean and free of residual sample. Not doing so may result in deposit build up on the upper part of the shaft and cause interference between the shaft and the pivot cup.



Be sure to remove spindle from the instrument prior to cleaning. Note left-hand thread. Severe instrument damage may result if spindle is cleaned in place.



When cleaning spindles, do not apply excessive force, which may result in bending the spindle shaft.

Cleaning Instrument, Keypad and Display:

Clean with dry, non-abrasive cloth. Do not use solvents or cleaners.

Immersed Components:

Spindles and guard leg are made of stainless steel. Clean with non-abrasive cloth and solvent appropriate for sample material that is not aggressive to stainless steel.

II. GETTING STARTED

II.1 Power Up

The DVE Viscometer will go through a power up sequence when the power is turned on. After pressing the POWER key, the viscometer will present the *About* screen for 3 seconds. The *About* screen is shown below and includes several critical parameters about the viscometer including: viscometer model, viscometer torque (LV, RV, HA, HB or other) and the firmware version number.

The *About* screen can also be accessed through the Options menu (see Section II.2).



Figure II-1

TIP: When contacting Brookfield AMETEK or your authorized Brookfield AMETEK dealer for technical support or repair services, please record the information on the *About* screen and the serial number (found on the serial tag located on the back of the instrument) in any correspondence or shipping paperwork.

The DVE will automatically transition from the *About* screen to the *Default* screen. The *Default* screen shows the measurement parameters chosen by the operator including: measured viscosity, speed, motor status, % torque and spindle (see Figure II-2). The units will flash prior to two complete spindle revolutions.



Figure II-2

II.2 Options

The DVE Viscometer provides an Options menu that allows the user to select the *About*, *Enter Service* and *Visc Units* screens. These functions provide instrument build and calibration information, access to service files and the ability to select the displayed units of viscosity. The Options menu is accessed from the *Default* screen. All user input is made through the keypad (see Section I.7 for a description of Key Functions).

Several keys are used on the DVE to access the Options menu. The function of each key is indicated below:



Press and hold the SPEED + and SPINDLE (Up arrow) keys simultaneously to go to the *Options* screen.



Press SPINDLE (Up arrow) and SPINDLE (Down arrow) keys to scroll through the *Options*, *Visc Units* and *Enter Service* screens.



Press the RANGE key to accept the currently displayed *Options* and *Visc Units* screen.

The *About* screen presents the information seen on the start up screen including viscometer name, viscometer model (LV, RV, HA, HB or other), the firmware version of the viscometer operating system, as well as the diagnostics screens with calibration parameters.



Figure II-3

The *Enter Service* screen is utilized by Brookfield AMETEK and Brookfield AMETEK servicing dealers. There is no customer use within this screen.



Figure II-4

The *Visc Units* screen displays the currently set viscosity units. The factory setting is cP. To change the Visc Units, press the spindle up or down key to scroll to the required units. Press the RANGE key to accept the change and return to the *Default* screen.



Figure II-5

II.3 Spindle Selection

DVELV Viscometers are provided with a set of four spindles and a narrow guard leg; DVERV Viscometers are provided with a set of six spindles and a wider guard leg; DVEHA and DVEHB Viscometers come with a set of six spindles and no guard leg (see Appendix F for more information on the guard leg).

The spindles are attached to the viscometer by screwing them onto the coupling nut on the lower shaft (see Figure II-6). Note that the spindles have a left-handed thread. The lower shaft should be secured and slightly lifted with one hand while screwing the spindle to the left. The face of the spindle nut and the matching surface on the lower shaft should be smooth and clean to prevent eccentric rotation of the spindle. Spindles can be identified by the number on the side of the spindle coupling nut.

The DVE requires a spindle entry code number to calculate viscosity values. The two-digit code for each spindle can be found in Appendix D.

Note: The DVE will display the spindle entry code that was in use when the power was turned off. Not all spindles have an entry code number that is the same as the spindle number. For example: the spindle code entry for spindle LV-1 is 61 and the spindle code for the UL Adapter is 00.



The motor should be OFF whenever spindles are being removed or attached.

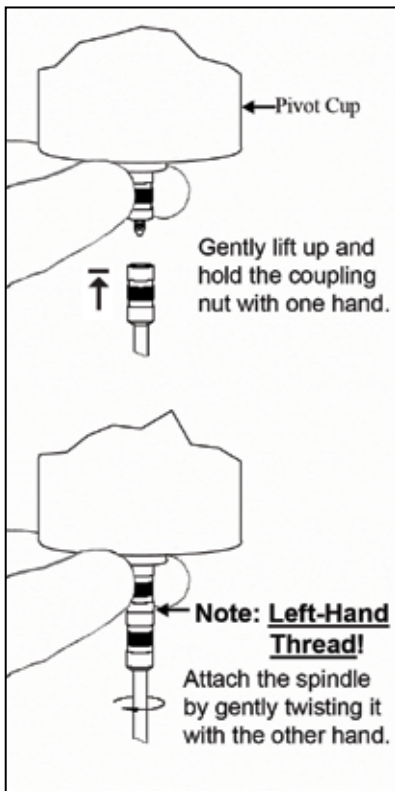

Figure II-6

From the *Default* screen, press the SPINDLE arrow keys to scroll through the list of available spindles until the correct spindle number is shown on the display.

The DVE will begin to calculate using the new spindle parameters after the spindle number is shown in the display. As the spindle number is changed, the Full Scale Range value will also change to reflect the new spindle number entered (refer to Section III.3).

Please see Brookfield AMETEK publication, “More Solutions to Sticky Problems” (Chapter 3), for information on how to select a spindle.

II.4 Speed Selection

There are 18 rotational speeds available on the DVE Viscometer. These speeds correspond to the standard LVF, LVT, RVF, RVT, HAT and HBT Dial Viscometer models, and they are combined sequentially (see Table II-1).

Note: Speed changes are not instantaneous when motor is on. There will be some acceleration/deceleration time as speed changes are entered.

DVE SPEEDS SETS	
↑	100
	60
	50
	30
	20
	12
	10
	6
	5
	4
	3
	2.5
	2
	1.5
	1
	0.6
When scrolling “UP”	0.5
	0.3

Table II-1

The *Default* screen displays the currently selected speed of rotation. Press the SPEED up/down arrow keys to scroll through the list of available speeds until the desired speed is shown on the display.

TIP: When setting a test procedure, be aware if the data must be compared to another site. If a comparison is required, it is best to utilize speeds that are traditionally associated with the torque range of the viscometer. This will ensure that all test sites will be able to reproduce the test method exactly.

Speeds: LV - 0.3, 0.6, 1.5, 3, 6, 12, 30, 60
 (RPM) RV/HA/HB - 0.5, 1, 2, 2.5, 4, 5, 10, 20, 50, 100

Note: The DVE uses stepper motor technology for speed control. Some electronic noise is normal. The noise level will vary with the selected speed.

The viscometer will rotate the spindle at the selected speed when the MOTOR ON/OFF key is pressed once.



Figure II-7 (MOTOR ON)

When the MOTOR ON/OFF key is pressed again, “OFF” will be displayed beside the speed.



Figure II-8 (MOTOR OFF)

Note: When the motor is ON, any change to the selected speed will be effective immediately. Also, when the motor is turned off, the display will hold the last measured torque value and measured viscosity.

The DVE Viscometer employs an optical signal pick-up inside the instrument to detect the torque value of the calibrated spring. This optical signal pick-up is recorded four times per revolution of the spindle. When the spindle begins to rotate at a defined speed, four torque values are recorded during the first full revolution of the spindle and averaged together. The display reports the average value for both torque (%) and viscosity (P, cP, Pa•S or mPa•s). Thereafter, the next torque value recorded by the optical signal pick-up is averaged together with the three preceding torque values and the newly calculated torque (%) and viscosity (P, cP, Pa•S or mPa•s) values are then displayed. This 4x revolution pick-up and display continues as long as the motor is on.

This algorithm in the instrument firmware is used for all viscosity and torque readings. Consequently, the wait time to observe the initial displayed readings for torque and viscosity increase with lower speeds.

It may also be necessary to allow time for the indicated reading to stabilize.

Note: At speeds of 1 RPM and lower, additional time may be required to allow for complete deflection of the torque sensor. The % (torque) and cP (viscosity) will flash until 2 revolutions are achieved and the % torque value is greater than 10%.

The time required for stabilization will depend on the speed at which the Viscometer is running and the characteristics of the sample fluid. For maximum accuracy, readings below 10% should be avoided. Additional information on making viscosity measurements is available in Appendix B or the Brookfield AMETEK publication “More Solutions to Sticky Problems”.

The DVE Viscometer will remember the selected speed and spindle when power is turned off. On start-up, the viscometer will be set to the previously selected spindle and speed.

Please see Brookfield AMETEK publication, “More Solutions to Sticky Problems” (Chapter 3), for information on how to select a speed.

II.5 Viscosity Units

The units of viscosity display can be configured as defined in the table below.

Unit Abbreviation	Unit	Equivalency
cP	Centipoise	100 cP = 1 P = 100 mPAS = 0.1 PAS
PAS (Pa•S)	Pascal Second	1 PAS = 1000 mPAS = 1000 cP = 10 P
mPAS (mPa•s)	Millipascal Second	1 mPAS = 1 cP = 0.01 P = 0.001 PAS
P	Poise	1 P = 100 cP = 100 mPAS = 0.1 PAS

Changes to the currently displayed viscosity units are made from the *Visc Units* screen in the Options Menu. To change the currently displayed Visc Units, press and hold both the SPEED UP and SPINDLE UP arrow keys simultaneously to display the *Options* screen. Use the SPINDLE UP or DOWN arrow keys to navigate to the *Visc Units* screen. Push the RANGE key to accept the *Visc Units* option. To change the currently set viscosity units, press the spindle up or down keys to scroll to the required value. Press the RANGE key to accept the change and return to the *Default* screen.

II.6 Range

In the *Default* screen, pressing the RANGE key allows you to determine the maximum viscosity (full scale reading) that can be measured by a spindle and speed combination when used with the specific spring torque of the DVE Viscometer. This value represents the measured viscosity which will be displayed when the instrument's % torque reading is at 100. Pressing the key at any time will cause the current viscosity display to change and show the maximum viscosity. The screen torque display will now display 100% to indicate this special condition. The maximum viscosity and 100% value will be displayed for as long as the RANGE key is depressed. Figure II-9 shows the RANGE function where the No. 2 RV spindle is rotating at 10 RPM. The Full Scale Range is 4000 cP (or 4000 mPa•s).



Figure II-9

Brookfield AMETEK recommends that viscosity measurements be made only when the instrument's % torque value is between 10 and 100. The FSR (Full Scale Range) represents the maximum value that can be measured (100% on the torque scale). The minimum viscosity that can be measured is 10% of the FSR (equivalent to 10 on the torque scale).

Full Scale Range is the same as Range or Autorange on previous versions of Brookfield AMETEK Viscometers.

The accuracy of the Brookfield AMETEK Viscometer is expressed as a percentage of the instrument's FSR. When using the standard LV (61-64) and RV (2-7) spindles, the instrument's accuracy is $\pm 1\%$ of the FSR (see Appendix E).

II.6 Out of Range

The DVE gives indications for out of specification or out of range operation. When torque % readings exceed 100.0% (over range), the display changes to that shown in Figure II-10. You must either reduce the speed or use a smaller size spindle to correct this condition. Audible noise may be heard in this case.



Figure II-10

If you operate at spindle speeds that produce torque below 10.0% (under-range), the DVE displays both torque % and viscosity (cP) with flashing unit designations, as shown in Figure II-11. You must either increase speed or use a larger size spindle to correct this condition.

The parameters of torque % and viscosity (cP) will also flash prior to two complete spindle revolutions. It is not recommended that readings are taken while parameters are flashing.



Figure II-11

Negative torque % will be displayed as shown in Figure II-12. Viscosity values will be displayed as “- - -” when the torque % is below zero.



Figure II-12

III. MAKING VISCOSITY MEASUREMENTS

III.1 Quick Start

The DVE Viscometer uses the same methodology for viscosity measurements as the Brookfield AMETEK Dial Reading Viscometer and the DV series of Digital Viscometers. If you have experience with other Brookfield AMETEK equipment, this section will give you the quick steps necessary for taking a viscosity reading. If you have not used a Brookfield AMETEK Viscometer before, skip this section and go to Section III.2 for a detailed description.

- A) Assemble the Laboratory Stand. Mount and level the DVE Viscometer (Section I.5).
- B) Connect the power supply to the instrument (see Section I.5) and press the power key.
- C) Select the spindle number using the SPINDLE UP and DOWN arrow keys (Section II.3).
- D) Select the speed of rotation using the SPEED UP and DOWN arrow keys (Section II.4)
- E) Introduce the spindle into the sample and attach the spindle to the coupling nut. **NOTE:** Left-handed threads.
- F) Press the MOTOR ON/OFF key to initiate test. When the test is completed, press the MOTOR ON/OFF key.
- G) Record the test results.
- H) Pressing the MOTOR ON/OFF key will repeat the last test.

III.2 Preparations for Making Measurements

- A) **VISCOMETER:** The DVE should be leveled and turned on. The level is adjusted using the three leveling screws on the bottom of the base and confirmed using the bubble on the front of the head. Adjust the leveling screws until bubble is inside the center target. Check the level prior to each measurement.

Proper level is essential for correct operation of the DVE.

- B) **SAMPLE:** The fluid to be measured (sample) must be in a container. The standard spindles, supplied with the DVE (LV (61-64), RV (2-7), or HA/HB (2-7)), are designed to be used with a 600 mL low form Griffin beaker (or equivalent container with a diameter of 8.25cm). The same applies to the optional RV1, HA/HB1 spindle. Many other spindle systems are supplied from Brookfield AMETEK with specific sample chambers such as the Small Sample Adapter, UL Adapter and Thermosel.

Brookfield AMETEK recommends that you use the appropriate container for the selected spindle. You may choose to use an alternate container for convenience; however, this may have an effect on the measured viscosity. The DVE is calibrated considering the specified container. Alternate containers will provide results that are repeatable but may not be “true.”

The LV (61-62) and RV (1-2) spindles are designed to be used with the supplied guard leg attached. Measurements made without the guard leg will provide repeatable results but may not provide “true” results.

When comparing data with others, be sure to specify the sample container and presence/absence of the guard leg.

Many samples must be controlled to a specific temperature for viscosity measurement. When conditioning a sample for temperature, be sure to temperature control the container and spindle as well as the sample.

Please see our publication, “More Solutions to Sticky Problems”, for more details relating to sample preparation.

III.3 Selecting a Spindle/Speed

The DVE has the capability of measuring viscosity over a wide range (for example, the DVERV can measure fluids within the range of 100-13,000,000 cP) (see Appendix A). This range is achieved through the use of several spindles over many speeds.

The process of selecting a spindle and speed for an unknown fluid is normally trial and error. **An appropriate selection will result in measurements between 10-100 on the instrument % torque scale.** Two general rules will help in the trial and error process.

1. Viscosity range is inversely proportional to the size of the spindle.
2. Viscosity range is inversely proportional to the rotational speed.

In other words: to measure high viscosity, choose a small spindle and/or a slow speed. If the chosen spindle/speed results in a reading above 100%, then reduce the speed or choose a smaller spindle.

Experimentation may reveal that several spindle/speed combinations will produce satisfactory results between 10-100%. When this circumstance occurs, any of the spindles may be selected.

Non-Newtonian fluid behavior can result in the measured viscosity changing if the spindle and/or speed is changed. See our publication, “More Solutions to Sticky Problems”, for more detail.

When viscosity data must be compared, be sure to use the same test methodology: the same instrument, spindle, speed, container, temperature and test time.

III.4 Running a Test

A viscosity test is started by pressing the MOTOR ON/OFF key. Measurement data will be displayed during the test. When the MOTOR ON/OFF key is pressed to end the test, the final data will be displayed on the DVE until the user presses a key. The following procedure outlines the general steps necessary for making a viscosity measurement in a 600 mL low form Griffin beaker using the standard LV (61-64)/RV/HA/HB (2-7) spindles.

1. Level the DVE Viscometer. Remove any attached spindles.
2. Prepare the sample to be tested and transfer to a 600 mL low form Griffin beaker.
3. When using an LV61, LV62, RV1 or RV2 spindle, attach the guard leg. Attach the spindle to the lower shaft. Lift the shaft slightly, holding it firmly with one hand while screwing the spindle on with the other (NOTE: Left-handed threads). Avoid putting side thrust on the shaft. With a disc-type spindle, it is sometimes necessary to tilt the spindle slightly

while immersing to avoid trapping air bubbles under the surface of the disc. **You may find it more convenient to immerse the spindle in this fashion before attaching it to the viscometer.** Center the spindle in the test material. The spindle should be inserted to the immersion groove located on the spindle shaft. Use the Laboratory Stand Clamp to adjust the height of the Viscometer.



Be sure the motor is off when changing spindles.

4. Select the spindle number into the DVE Viscometer by using the SPINDLE UP/DOWN key. Select the speed of rotation by using the SPEED UP/DOWN key.
5. To make a viscosity measurement, press the MOTOR ON/OFF key. Allow time for the indicated reading to stabilize. For maximum accuracy, flashing readings below 10% should be avoided. Additional information on making viscosity measurements is available in Chapter 3 of the Brookfield AMETEK publication “More Solutions to Sticky Problems”.
6. The test is stopped by pressing the MOTOR ON/OFF key.

If your test procedure calls for data collected at more than one speed, change the speed of rotation during the test.

7. Record the reading and relevant test parameters. Brookfield AMETEK recommends you record at a minimum both % Torque and viscosity. Relevant test parameters might include: viscometer model, spindle, speed, temperature, container size and time of test. See the sample Viscosity Test Report at the end of the Appendices. Remove the spindle and guard leg before cleaning. Remember to secure the viscometer shaft and lift up slightly while removing the spindle. Clean the spindles and guard leg after each use. See Section I.9 for general cleaning recommendations.
8. Interpretation of results and the instrument’s use with non-Newtonian and thixotropic materials is discussed in the publication, “More Solutions to Sticky Problems”, and in Appendix C: Variables in Viscosity Measurements.

Appendix A - Viscosity Ranges

LV (#61-64) and RV,HA,HB (#1-7) Viscometers

Viscosity Range (cP)		
Viscometer	Minimum	Maximum
DVELV	15	2,000,000
DVERV	100*	13,300,000
DVEHA	200*	26,600,000
DVEHB	800*	106,400,000

**Minimum viscosity is achieved with optional RV/HA/HB-1 spindle. (Spindle Code 01)*

Vane Spindles

Spindle	Torque Range	Shear Stress Range		Viscosity Range cP (mPa•s) @ 10 RPM	
		Pa	dyne/cm ²		
V-71	LV	NOT RECOMMENDED FOR USE ON LV TORQUE			
V-72	LV	.188-1.88	1.88-18.8	199 -	1990
V-73	LV	.938-9.38	9.38-93.8	996 -	9960
V-74	LV	9.38-93.8	93.8-938	4990 -	49900
V-75	LV	3.75-37.5	37.5-375	1996 -	19960
V-71	RV	.5-5	5-50	262 -	2620
V-72	RV	2-20	20-200	1110 -	11100
V-73	RV	10-100	100-1000	5350 -	53500
V-74	RV	100-1000	1000-10000	54300 -	543000
V-75	RV	40-400	400-4000	21300 -	213000
V-71	HA	1-10	10-100	524 -	5240
V-72	HA	4-40	40-400	2220 -	22200
V-73	HA	20-200	200-2000	10700 -	107000
V-74	HA	200-2000	2000-20000	108600 -	1086000
V-75	HA	80-800	800-8000	42600 -	426000
V-71	HB	4-40	40-400	2096 -	20960
V-72	HB	16-160	160-1600	8880 -	88800
V-73	HB	80-800	800-8000	42800 -	428000
V-74	HB	800-8000	8000-80000	434400 -	4344000
V-75	HB	320-3200	3200-32000	170400 -	1704000

Notes: 1) 1 Pa = 10 dyne/cm²

2) 1 cP = 1 mPa•s

3) Possibility of turbulence at speeds above 10 RPM may give artificially higher viscosity readings.

Small Sample Adapter and Thermosel

SSA and Thermosel Spindle	Viscosity Range (cP)		Shear Rate sec ⁻¹
	DVELV		
SC4-16	120	- 400,000	.29N
SC4-18	3	- 10,000	1.32N
SC4-25	480	- 1,600,000	.22N
SC4-31	30	- 100,000	.34N
SC4-34	60	- 200,000	.28N
SC4-81	3	- 10,000	1.29N
SC4-82	3	- 10,000	1.29N
SC4-83	11	- 38,000	1.29N

SSA and Thermosel Spindle	Viscosity (cP)			Shear Rate sec ⁻¹
	DVERV	DVEHA	DVEHB	
SC4-14	1,250 - 4,165,000	2,500 - 8,330,000	10,000 - 33,360,000	.40N
SC4-15	500 - 1,660,000	1,000 - 3,320,000	4,000 - 13,280,000	.48N
SC4-21	50 - 167,000	100 - 334,000	400 - 1,336,000	.93N
SC4-27	250 - 830,000	500 - 1,660,000	2,000 - 6,640,000	.34N
SC4-28	500 - 1,660,000	1,000 - 3,320,000	4,000 - 3,280,000	.28N
SC4-29	1,000 - 3,330,000	2,000 - 6,660,000	8,000 - 26,640,000	.25N
Thermosel SC4-81	37 - 10,000	73.0 - 10,000	292 - 10,000	1.29N
SSA SC4-82	37 - 10,000	73.0 - 10,000	292 - 10,000	1.29N
SSA SC4-83	121 - 50,000	243 - 50,000	970 - 50,000	1.29N

UL Adapter

UL Spindle	Viscosity (cP)				Shear Rate sec ⁻¹
	DVELV	DVERV	DVEHA	DVEHB	
YULA-15 or 15Z	1 - 2,000	7 - 2,000	13 - 2,000	52 - 2,000	1.22N
ULA-DIN-Y	1 - 3,800	11 - 5,000	22 - 5,000	85 - 2000	1.29N

DIN Adapter Accessory

DAA Spindle	Viscosity (cP)				Shear Rate sec-1
	DVELV	DVERV	DVEHA	DVEHB	
85	2 - 4,000	12 - 5,000	24 - 5,000	98 - 5,000	1.29N
86	4 - 11,000	37 - 10,000	73 - 10,000	292 - 10,000	1.29N
87	11 - 38,000	121 - 50,000	243 - 50,000	970 - 50,000	1.29N

Spiral Adapter

Spiral Spindle	Viscosity (cP)				Shear Rate sec-1
	DVELV	DVERV	DVEHA	DVEHB	
SA-70	98 - 98,500	1,000 - 1,050,000	2,100 - 2,100,000	8,400 - 8,400,000	.00677 - .677N (1-100 RPM)

Helipath with T-Bar Spindles

T-Bar Spindle	Viscosity (cP)			
	DVELV	DVERV	DVEHA	DVEHB
T-A	156 - 62,400	2,000 - 400,000	4,000 - 800,000	16,000 - 3,200,000
T-B	312 - 124,800	4,000 - 800,000	8,000 - 1,600,000	32,000 - 6,400,000
T-C	780 - 312,000	10,000 - 2,000,000	20,000 - 4,000,000	80,000 - 16,000,000
T-D	1,560 - 624,000	20,000 - 4,000,000	40,000 - 8,000,000	160,000 - 32,000,000
T-E	3,900 - 1,560,000	50,000 - 10,000,000	100,000 - 20,000,000	400,000 - 80,000,000
T-F	7,800 - 3,120,000	100,000 - 20,000,000	200,000 - 40,000,000	800,000 - 160,000,000

When taking viscosity measurements with the DVE Viscometer, there are two considerations, which pertain to the low viscosity limit of effective measurement.

1. Viscosity measurements should be taken within the equivalent % Torque Range from 10% to 100% for any combination of spindle/speed rotation.
2. Viscosity measurements should be taken under laminar flow conditions, not under turbulent flow conditions.

The first consideration has to do with the accuracy of the instrument. All DVE Viscometers have a Full Scale Range allowable error of (+/-) 1% of any spindle/speed in use. We discourage taking readings below 10% of range because the potential viscosity error of (+/-) 1% is a relatively high number compared to the instrument reading.

The second consideration involves the mechanics of fluid flow. All rheological measurements of fluid flow properties should be made under laminar flow conditions. Laminar flow is flow wherein all particle movement is in layers directed by the shearing force. For rotational systems, this means

all fluid movement must be circumferential. When the inertial forces on the fluid become too great, the fluid can break into turbulent flow wherein the movement of fluid particles becomes random and the flow cannot be analyzed with standard math models. This turbulence creates a falsely high viscometer reading with the degree of non-linear increase in reading being directly related to the degree of turbulence in the fluid.

For the following geometries, we have found that an approximate transition to the onset of turbulent flow occurs in the following situation:

- 1) No. 1 LV Spindle: 15 **cP** at 60 RPM
- 2) No. 2 LV Spindle: 100 **cP** at 200 RPM
- 3) No. 1 RV Spindle: 100 **cP** at 50 RPM (optional spindle available from Brookfield AMETEK)
- 4) UL Adapter: 0.85 **cP** at 60 RPM

Turbulent conditions may exist in these situations whenever the RPM/cP ratio exceeds the values listed above. The viscosity at which turbulence starts is still at best a guess because it is a relationship between viscous and inertial forces, and it can vary dramatically from fluid to fluid. Turbulence starts as a small deviation or increase in viscosity for a Newtonian fluid and grows quickly. Basically, there is no specific shear that it starts at, only an approximate region of shear depending on the fluid.

Appendix B - Variables in Viscosity Measurement

As with any instrument measurement, there are variables that can affect a viscometer measurement. These variables may be related to the instrument (viscometer), or the test fluid. Variables related to the test fluid deal with the rheological properties of the fluid, while instrument variables would include the viscometer design and the spindle geometry system utilized.

Rheological Properties

Fluids have different rheological characteristics that can be described by viscometer measurements. We can then work with these fluids to suit the lab or process conditions.

There are two categories of fluids:

Newtonian

- These fluids have the same viscosity at different Shear Rates (different RPM's) and are called Newtonian over the Shear Rate range they are measured.

Non-Newtonian

- These fluids have different viscosities at different shear rates (different RPM's). They fall into two groups:
 - 1) Time Independent
 - 2) Time Dependent

Time Independent means that the viscosity behavior does not change as a function of time when measuring at a specific shear rate.

Pseudoplastic

- A pseudoplastic material displays a decrease in viscosity with an increase in shear rate, and is also known as “shear thinning”. If you take viscometer readings from a low to a high RPM and then back to the low RPM, and the readings fall upon themselves, the material is time independent, pseudoplastic and shear thinning.

Time Dependent means that the viscosity behavior changes as a function of time when measuring at a specific shear rate.

Thixotropic

- A thixotropic material has decreasing viscosity under constant shear rate. If you set a viscometer at a constant speed recording viscosity values over time and find that the viscosity values decrease with time, the material is thixotropic.

The Brookfield AMETEK publication, “More Solutions to Sticky Problems”, includes a more detailed discussion of rheological properties and non-Newtonian behavior.

Viscometer Related Variables

Most fluid viscosities are found to be non-Newtonian. They are dependent on Shear Rate and the spindle geometry conditions. The specifications of the viscometer spindle and chamber geometry will affect the viscosity readings. If one reading is taken at 2.5 rpm, and a second at 50 rpm, the two viscosity values produced will be different because the readings were made at different shear rates. The faster the spindle speed, the higher the shear rate.

The shear rate of a given measurement is determined by: the rotational speed of the spindle, the size and shape of the spindle, the size and shape of the container used and therefore, the distance between the container wall and the spindle surface.

A repeatable viscosity test should control or specify the following:

- 1) Test temperature
- 2) Sample container size (or spindle/chamber geometry)
- 3) Sample volume
- 4) Viscometer model
- 5) Spindle number used
- 6) Test speed or speeds (or the shear rate)
- 7) Length of time or number of spindle revolutions to record viscosity
- 8) Presence/absence of guard leg (LV or RV models)

Appendix C - Spindle Entry Codes and SMC/SRC Values

When using a standard Brookfield AMETEK digital Viscometer, each spindle has a two digit entry code which is entered via the keypad on the DVE. The entry code allows the DVE to calculate Viscosity.

Each spindle has two constants which are used in these calculations. The Spindle Multiplier Constant (SMC) used for viscosity and shear stress calculations, and the Shear Rate Constant (SRC), used for shear rate and shear stress calculations.

Table C-1
(Continued on following page)

SPINDLE	ENTRY	SMC	SRC
RV1	01	1	0
RV2	02	4	0
RV3	03	10	0
RV4	04	20	0
RV5	05	40	0
RV6	06	100	0
RV7	07	400	0
HA1	01	1	0
HA2	02	4	0
HA3	03	10	0
HA4	04	20	0
HA5	05	40	0
HA6	06	100	0
HA7	07	400	0
HB1	01	1	0
HB2	02	4	0
HB3	03	10	0
HB4	04	20	0
HB5	05	40	0
HB6	06	100	0
HB7	07	400	0
LV1	61	6.4	0
LV2	62	32	0
LV3	63	128	0
LV4 or 4B2	64	640	0
LV5	65	1280	0
LV-2C	66	32	0.212
LV-3C	67	128	0.210
SA-70	70	105	0.677
T-A	91	20	0
T-B	92	40	0
T-C	93	100	0

SPINDLE	ENTRY	SMC	SRC
T-D	94	200	0
T-E	95	500	0
T-F	96	1000	0
ULA	00	0.64	1.223
HT-DIN-81	81	3.7	1.29
SC4-DIN-82	82	3.75	1.29
SC4-DIN-83	83	12.09	1.29
DIN-85	85	1.22	1.29
DIN-86	86	3.65	1.29
DIN-87	87	12.13	1.29
SC4-14	14	125	0.4
SC4-15	15	50	0.48
SC4-16	16	128	0.29
SC4-18	18	3.2	1.32
SC4-21	21	5	0.93
SC4-25	25	512	0.22
SC4-27	27	25	0.34
SC4-28	28	50	0.28
SC4-29	29	100	0.25
SC4-31	31	32	0.34
SC4-34	34	64	0.28
V-71	71	2.62	0
V-72	72	11.1	0
V-73	73	53.5	0
V-74	74	543	0
V-75	75	213	0

Table C-1
(Continued from previous page)

Table C-2 lists the model codes and spring torque constants for each viscometer model.

VISCOMETER MODEL	TORQUE CONSTANT TK	MODEL CODE ON DVE SCREEN
DVELV	0.09375	LV
2.5xDVELV	0.234375	2.5LV
5xDVELV	0.46875	5LV
12DVELV	1.125	12LV
1/4DVERV	0.25	1/4RV
1/2DVERV	0.5	1/2RV
DVERV	1	RV
DVEHA	2	HA
2xDVEHA	4	2HA
2.5xDVEHA	5	2.5HA
DVEHB	8	HB

Table C-2

The full scale viscosity range for any DVE model and spindle may be calculated using the equation:

$$\text{Full Scale Viscosity Range [cP]} = \text{TK} * \text{SMC} * \frac{10,000}{\text{RPM}}$$

where:

TK = DVE Torque Constant from Table C-2

SMC = Spindle Multiplier Constant from Table C-1

The Shear Rate calculation is:

$$\text{Shear Rate (1/sec)} = \text{SRC} * \text{RPM}$$

where:

SRC = Shear Rate Constant from Table C-1

Appendix D - Spindle Entry Codes and Range Coefficients

The range coefficient is a convenient tool for quickly determining the maximum viscosity that can be measured with a specific spindle/speed combination. Identify the spindle in use and the torque range (LV, RV, HA, HB) of the Viscometer. Look up the Range Coefficient in the following table. Divide the Range Coefficient by the spindle speed to determine the maximum viscosity in centipoise that can be measured.

E.g. RV Viscometer with RV3 spindle: Range Coefficient is 100,000. At 50 RPM, the maximum viscosity that can be measured is 100,000/50 or 2,000 cP.

The Entry Code is the two digit number used to identify the spindle in use when operating a standard digital Viscometer.

Table D-1
(Continued on following page)

Spindle	Entry Code	Range Coefficient			
		LV	RV	HA	HB
RV1	01	937	10,000	20,000	80,000
RV2	02	3,750	40,000	80,000	320,000
RV3	03	9,375	100,000	200,000	800,000
RV4	04	18,750	200,000	400,000	1,600,000
RV5	05	37,500	400,000	800,000	3,200,000
RV6	06	93,750	1,000,000	2,000,000	8,000,000
RV7	07	375,000	4,000,000	8,000,000	32,000,000
HA1	01	937	10,000	20,000	80,000
HA2	02	3,750	40,000	80,000	320,000
HA3	03	9,375	100,000	200,000	800,000
HA4	04	18,750	200,000	400,000	1,600,000
HA5	05	3,7500	400,000	800,000	3,200,000
HA6	06	93,750	1,000,000	2,000,000	8,000,000
HA7	07	375,000	4,000,000	8,000,000	32,000,000
HB1	01	937	10,000	20,000	80,000
HB2	02	3,750	40,000	80,000	320,000
HB3	03	9,375	100,000	200,000	800,000
HB4	04	18,750	200,000	400,000	1,600,000
HB5	05	37,500	400,000	800,000	3,200,000
HB6	06	93,750	1,000,000	2,000,000	8,000,000
HB7	07	375,000	4,000,000	8,000,000	32,000,000
LV1	61	6,000	64,000	128,000	512,000
LV2	62	30,000	320,000	640,000	2,560,000
LV3	63	120,000	1,280,000	2,560,000	10,240,000
LV4 or 4B2	64	600,000	6,400,000	12,800,000	51,200,000
LV5	65	1,200,000	12,800,000	25,600,000	102,400,000

Spindle	Entry Code	Range Coefficient			
		LV	RV	HA	HB
LV-2C	66	30,000	320,000	640,000	2,560,000
LV-3C	67	120,000	1,280,000	2,560,000	10,240,000
T-A	91	18,750	200,000	400,000	1,600,000
T-B	92	37,440	400,000	800,000	3,200,000
T-C	93	9,3600	1,000,000	2,000,000	8,000,000
T-D	94	187,200	2,000,000	4,000,000	16,000,000
T-E	95	468,000	5,000,000	10,000,000	40,000,000
T-F	96	936,000	10,000,000	20,000,000	80,000,000
SA-70	70	98,400	1,050,000	2,100,000	8,400,000
ULA	00	600	6,400	12,800	51,200
HT-DIN-81	81	3,420	36,500	73,000	292,000
SC4-DIN-82	82	3,420	36,500	73,000	292,000
SC4-DIN-83	83	11,340	121,300	242,600	970,400
ULA-DIN-85	85	1,144	12,200	24,400	97,600
ULA-DIN-86	86	3,420	36,500	73,000	292,000
ULA-DIN-87	87	11,340	121,300	242,600	970,400
SC4-14/6R	14	117,200	1,250,000	2,500,000	10,000,000
SC4-15/7R	15	46,880	500,000	1,000,000	4,000,000
SC4-16/8R	16	120,000	1,280,000	2,560,000	10,240,000
SC4-18/13R	18	3,000	32,000	64,000	256,000
SC4-21/13R	21	4,688	50,000	100,000	400,000
SC4-25/13R	25	480,000	5,120,000	10,240,000	40,960,000
SC4-27/13R	27	23,440	250,000	500,000	2,000,000
SC4-28/13R	28	46,880	500,000	1,000,000	4,000,000
SC4-29/13R	29	93,750	1,000,000	2,000,000	8,000,000
SC4-31/13R	31	30,000	320,000	640,000	2,560,000
SC4-34/13R	34	60,000	640,000	1,280,000	5,120,000
V-71	71	2,456	26,200	52,400	209,600
V-72	72	10,404	111,000	222,000	888,000
V-73	73	50,146	535,000	1,070,000	4,280,000
V-74	74	508,954	5,430,000	10,860,000	43,440,000
V-75	75	199,645	2,130,000	4,260,000	8,520,000

*Table D-1
(Continued from previous page)*

Appendix E - Calibration Check Procedures

For more help go to
www.brookfieldengineering.com and download the video.

Brookfield AMETEK's accuracy statement for viscometers used with standard spindles is +/-1% of Full Scale Range (FSR). When measuring viscosity with a specific spindle rotating at a defined speed, the maximum viscosity that can be measured is defined as FSR. For digital viscometers this value is easily determined by pressing the RANGE key. The display will show the FSR viscosity in cP or mPa•s and the torque value will show 100%. Multiply the FSR viscosity by 1% to determine the accuracy of any future measurement made with that spindle/speed combination.

When using the following accessory devices with your viscometer, the accuracy is +/-2%. Dimensional tolerances in the accessory device allow for increase from +/-1% to +/-2%.

- Small Sample Adapter
- Thermosel
- UL Adapter
- DIN Adapter
- Spiral Adapter

The accuracy of the DVE is verified using viscosity standard fluids, which are available from Brookfield AMETEK or your local Brookfield AMETEK agent. Viscosity standards are Newtonian, and therefore, have the same viscosity regardless of spindle speed (or shear rate). Viscosity standards, calibrated at 25°C, are shown in **Table F-1** (Silicone Oils) and **Table F-2** (Mineral Oils).

Container size: For Viscosity Standards < 30,000 cP, use a 600 mL Low Form Griffin Beaker having a working volume of 500 mL.

Inside Diameter: 3.25”(8.25cm)

Height: 4.75”(12.1cm)

For Viscosity Standards ≥ 30,000 cP, use the fluid container.

Note: Container may be larger, but may not be smaller.

Temperature: As stated on the fluid standard label: (+/-) 0.1°C

Conditions: The DVE should be set according to the operating instructions. The water bath must be stabilized at test temperature. Viscometers with the letters “LV” or “RV” in the model designation must have the guard leg attached, see Appendix F for more information on the guard leg).

Normal 25°C Standard Fluids		High Temperature Standard Fluids
Viscosity (cP)	Viscosity (cP)	Three Viscosity/Temperatures**
5	5,000	HT-30,000
10	12,500	HT-60,000
50	30,000	HT-100,000
100	60,000	
500	100,000	**25°C, 93.3°C, 149°C
1,000		Refer to Brookfield AMETEK catalog for more information

MINERAL OIL VISCOSITY STANDARD FLUIDS	
BEL Part No.	Viscosity (cP) 25°C
B29	29
B200	200
B400	400
B600	600
B1060	1,060
B2000	2,000
B10200	10,200
B21000	21,000
B730000	73,000
B200000	200,000
B360000	360,000

Table F-2

Brookfield AMETEK Viscosity Standard Fluid - General Information

The calibration of the Brookfield AMETEK viscometer can be verified through the use of calibrated viscosity standard fluids. The Brookfield AMETEK viscometer operates through the use of a calibration torque sensor with variable spindle geometry and rotational speeds. If the viscometer passes a calibration check using one measurement geometry across several speeds (verifying performance over a range of % torque values), then one can conclude that the viscometer is operating properly across the entire range of speeds and all spindles that can be utilized.

When choosing viscosity standard fluids, Brookfield AMETEK recommends that you select viscosity values that facilitate the ease of use of the viscosity standard fluid. In general, this means that we recommend that you choose a low viscosity value which is within the range of the measurement system utilized. A low viscosity value calibration standard will help facilitate thermal equilibrium, the removal of air bubbles, and the handling of the fluid between the viscosity standard jar and the measurement chamber (600 mL low form beaker or other sample chamber utilized with Brookfield AMETEK accessories). For this reason, it is not necessary to have a calibration standard with the exact value as your experiment material or even a calibration standard near the value of your test sample. In general, it is recommended that once you have selected a measurement geometry for the calibration check, measurement data can be collected over a range of rotational speeds so that measurements are made at several different values across the instrument % torque scale.

We recommend that Brookfield AMETEK Viscosity Standard Fluids be replaced on an annual basis, one year from date of initial use. These fluids are either pure silicone or mineral oil and are not subject to change over time. However, exposure to outside contaminants through normal use requires replacement on an annual basis. Contamination may occur by the introduction of solvent, standard of different viscosity or other foreign material.

Viscosity Standard Fluids may be stored under normal laboratory conditions. Mineral oils should be stored in the container in which they are supplied. Disposal should be in accordance with state, local and federal regulations as specified on the material safety data sheet; MSDS information is available upon request on our website to download.

Brookfield AMETEK does not recertify Viscosity Standard Fluids. We will issue duplicate copies of the Certificate of Calibration for any fluid within two years of the purchase date.

Brookfield AMETEK Viscosity Standard Fluids are reusable provided they are not contaminated. Normal practice for usage in a 600 mL beaker is to return the material from the beaker back into the bottle. When using smaller volumes in accessories such as Small Sample Adapter, UL Adapter, Thermosel or Spiral Adapter, the fluid is normally discarded.

Calibration Check Procedure for LV (#61-63) and RV,HA,HB (#1-6) Brookfield Spindles

NOTE: The LV-4 (#64) and the RV, HA, HB #7 spindles have been omitted from this procedure. Brookfield AMETEK does not recommend the use of these spindles to perform a calibration check on your instrument. Reasons pertain to the small amount of spindle surface area that makes contact with the viscosity standard, the difficulty of establishing the immersion mark precisely and the need for precise temperature control at 25°C in the immediate vicinity of the spindle. When using RV-1 or HA/HB-1 spindles for calibration, select speeds less than 50 rpm and use a viscosity standard greater than 100 cP.

Follow these steps using one of the recommended spindles to verify calibration of your instrument.

- 1) Place the viscosity standard fluid (in the proper container) into the water bath.
- 2) Lower the DVE into measurement position (with guard leg if LV or RV series viscometer is used).
- 3) Attach the spindle to the viscometer. If you are using a disk shaped spindle, avoid trapping air bubbles beneath the disk by first immersing the spindle at an angle, and then connecting it to the viscometer.
- 4) The viscosity standard fluid, together with the spindle and guard leg, should be immersed in the bath for a **minimum** of 1 hour, stirring the fluid periodically, prior to taking measurements.

 Don't introduce air bubbles.

The spindle can be rotated in the fluid to accelerate temperature equilibrium.

- 5) After 1 hour, check the temperature of the viscosity standard fluid with an accurate thermometer. Fluid must be within $\pm 0.1^\circ\text{C}$ of the specified temperature, normally 25°C. Allow longer soak time if required to come to test temperature.
- 6) If the fluid is at test temperature, measure the viscosity and record the viscometer reading; include % and cP (mPa•s).

NOTE: The spindle must rotate at least five (5) times before readings are taken.

- 7) The viscosity reading should equal the **cP** value on the viscosity fluid standard to within the combined accuracies of the viscometer and the standard (as discussed in the end of this section entitled, **Interpretation of Calibration Test Results**).

Calibration Check Procedure for a Small Sample Adapter

When a Small Sample Adapter is used, the water jacket is connected to the water bath and the water is stabilized at the proper temperature:

- 1) Put the proper amount of viscosity standard fluid into the sample chamber. The amount varies with each spindle/chamber combination. (Refer to the Small Sample Adapter instruction manual.)
- 2) Place the sample chamber into the water jacket.
- 3) Put the spindle into the test fluid and attach the extension link, coupling nut and free hanging spindle (or directly attach the solid shaft spindle) to the DVE.
- 4) Allow sufficient time for the viscosity standard, sample chamber and spindle to reach test temperature.
- 5) Measure the viscosity and record the viscometer reading; include % and cP (mPa•s).

NOTE: The spindle must rotate at least five (5) times before readings are taken.

- 6) Measure viscosity and record the viscometer reading; include % and cP (mPa•s). Instrument accuracy is $\pm 2\%$ of the maximum viscosity range and not the standard 1%.

Calibration Check Procedure for a Thermosel System

A two-step process is recommended for the Thermosel.

- 1) Evaluate the calibration of the Viscometer alone according to the procedure outlined in the beginning of this section, entitled **Calibration Procedure for LV (#61-63) and RV, HA, HB (#1-6) Brookfield AMETEK spindles**.
- 2) Evaluate the Viscometer with the Thermosel according to the procedure described below.

When a Thermosel System is used, the controller stabilizes the Thermo Container at the test temperature. **DO NOT USE THE THERMOSEL TO CONTROL TO TEMPERATURES WITHIN 15° OF AMBIENT TEMPERATURES.** Consult your Thermosel manual for details.

- 3) Put the proper amount of HT viscosity standard fluid into the HT-2 sample chamber. The amount varies with the spindle used. (Refer to the Thermosel instruction manual).
- 4) Place the sample chamber into the Thermo Container.
- 5) Put the spindle into the test fluid and attach the extension link, coupling nut and free hanging spindle (or directly attach the solid shaft spindle) to the DVE.
- 6) Allow sufficient time for the viscosity standard, sample chamber and spindle to reach test temperature.
- 7) Measure the viscosity and record the viscometer reading; include % and cP (mPa•s).

NOTE: The spindle must rotate at least five (5) times before readings are taken.

- 8) Measure viscosity and record the viscometer reading; include % and cP (mPa•s). Instrument accuracy is $\pm 2\%$ of the maximum viscosity range and not the standard 1%.

Calibration Check Procedures for UL Adapter

When a UL Adapter is used, the water bath is stabilized at the proper temperature:

- 1) Put the proper amount of viscosity standard fluid into the UL closed Tube. (Refer to the UL Adapter instruction manual).
- 2) Attach the spindle (with coupling nut) onto the DVE.
- 3) Attach the tube to the mounting bracket.
- 4) Lower the tube into the water bath reservoir, or if using the ULA-40Y water jacket, connect the inlet/outlets to the bath external circulating pump.
- 5) Allow sufficient time for the viscosity standard, sample chamber and spindle to reach test temperature.
- 6) Measure the viscosity and record the viscometer reading; include % and cP (mPa•s).

NOTE: The spindle must rotate at least five (5) times before readings are taken.

- 7) Measure viscosity and record the viscometer reading; include % and cP (mPa•s). Instrument accuracy is $\pm 2\%$ of the maximum viscosity range and not the standard 1%.

Calibration Check Procedures for DIN Adapter

When a DIN Adapter is used, the water bath is stabilized at the proper temperature:

- 1) Put the proper amount of viscosity standard fluid into the sample chamber. (Refer to the DIN Adapter instruction manual).
- 2) Attach the spindle onto the DVE.
- 3) Attach the tube to the mounting channel.
- 4) Lower the tube into the water bath reservoir, or if using the ULA-40SY water jacket, connect the inlet/outlets to the bath external circulating pump.
- 5) Allow sufficient time for the viscosity standard, sample chamber and spindle to reach test temperature.
- 6) Measure the viscosity and record the viscometer reading; include % and cP (mPa•s).

NOTE: The spindle must rotate at least five (5) times before readings are taken.

- 7) Measure viscosity and record the viscometer reading; include % and cP (mPa•s). Instrument accuracy is $\pm 2\%$ of the maximum viscosity range and not the standard 1%.

Calibration Check Procedure for a Helipath Stand and T-Bar Spindles

T-Bar spindles **should not** be used for verifying calibration of the DVE Viscometer.

When a Helipath Stand and T-Bar spindles are used:

Remove the T-bar spindle and select a standard LV (#61-63) or RV,HA,HB (#1-6) spindle. Follow the procedures in the beginning of this section, entitled **Calibration Procedure for LV (#61-63) and RV, HA, HB (#1-6) Brookfield AMETEK spindles.**

Calibration Check Procedure for Spiral Adapter

- 1) Place the viscosity standard fluid (in the proper container) into the water bath.
- 2) Attach the spindle to the viscometer. Attach chamber (SA-1Y) and clamp to the viscometer.
- 3) Lower the DVE into measurement position. Operate the viscometer at 50 or 60 RPM until the chamber is fully flooded.
- 4) The viscosity standard fluid, together with the spindle, should be immersed in the bath.



Don't introduce air bubbles.

Stirring the fluid periodically (operate at 50 or 60 RPM), prior to taking measurements to encourage temperature equilibrium.

NOTE: The spindle must rotate at least five (5) times before readings are taken.

- 5) Measure viscosity and record the viscometer reading; include % and cP (mPa•s). Instrument accuracy is $\pm 2\%$ of the maximum viscosity range and not the standard 1%.

Interpretation of Calibration Test Results:

When verifying the calibration of the DVE, the instrument and viscosity standard fluid error must be combined to calculate the total allowable error.

The DVE is accurate to (+/-) 1% of any full scale spindle/speed viscosity range.

Brookfield AMETEK Viscosity Standard Fluids are accurate to (+/-) 1% of their stated value.

Example 1: Calculate the acceptable range of viscosity using DVERV with RV-3 Spindle at 2 RPM; Brookfield AMETEK Standard Fluid 12,500 with a viscosity of 12,257 cP at 25°C:

- 1) Determine full scale viscosity range using the RANGE key on your instrument or calculate with equation:

$$\text{Full Scale Viscosity Range [cP]} = \text{TK} * \text{SMC} * \frac{10,000}{\text{RPM}}$$

Where:

TK = 1.0 from **Table C-2** (In Appendix C)

SMC = 10 from **Table C-1** (In Appendix C)

$$\text{Full Scale Viscosity Range } \frac{1 * 10 * 10,000}{2} = 50,000 \text{ cP}$$

The viscosity is accurate to (+/-) 500 **cP** (which is 1% of 50,000).

- 2) The viscosity standard fluid is 12,257 **cP**. Its accuracy is (+/-) 1% of 12,257 or (+/-) 122.57 **cP**.
- 3) Total allowable error is (122.57 + 500) **cP** = (+/-) 622.57 **cP**.
- 4) Therefore, any viscosity reading between 11,634.4 and 12,879.6 **cP** indicates that the viscometer is operating correctly. Any reading outside these limits may indicate a viscometer problem. Contact the Brookfield AMETEK technical sales department or your local authorized Brookfield AMETEK dealer with test results to determine the nature of the problem.

Example 2: Calculate the acceptable range of viscosity using DVERV with Small Sample adapter at 10 RPM; Brookfield AMETEK Standard Fluid 12,500 with a viscosity of 12,257 **cP** at 25°C:

- 1) Determine Full Scale Viscosity Range by pressing the RANGE key on your instrument. Display shows 25,000 cP. The viscosity is accurate to +/- 500 cP (which is 2% of 25,000 cP).
- 2) The viscosity standard fluid is 12,257 **cP**. Its accuracy is (+/-) 1% of 12,257 or (+/-) 122.57 **cP**.
- 3) Total allowable error is (122.57 + 500) **cP** = (+/-) 622.57 **cP**.
- 4) Therefore, any viscosity reading between 11,634.4 and 12,879.6 **cP** indicates that the viscometer is operating correctly. Any reading outside these limits may indicate a viscometer problem. Contact the Brookfield AMETEK technical sales department or your local authorized Brookfield AMETEK dealer with test results to determine the nature of the problem.

Appendix F - The Brookfield AMETEK Guard Leg

The guard leg was originally designed to protect the spindle during use. The first applications of the Brookfield AMETEK Viscometer included hand held operation while measuring fluids in a 55-gallon drum. It is clear that under those conditions the potential for damage to the spindle was great. Original construction included a sleeve that protected the spindle from side impact. Early RV guard legs attached to the dial housing and LV guard legs attached to the bottom of the pivot cup with a twist and lock mechanism.

The current guard leg is a band of metal in the shape of the letter U with a bracket at the top that attaches to the pivot cup of a Brookfield AMETEK Viscometer/Rheometer. A guard leg is supplied with all LV and RV series instruments, but not with the HA or HB series. Its shape (shown in Figures G-1 and G-2) is designed to accommodate the spindles of the appropriate spindle set; therefore, the RV guard leg is wider than the LV due to the large diameter of the RV-1 and RV-2 spindles. The RV and LV guard legs are not interchangeable.

The calibration of the Brookfield AMETEK Viscometer/Rheometer is determined using a 600 mL Low Form Griffin Beaker. The calibration of LV and RV series instruments includes the guard leg. The beaker wall (for HA/HB instruments) or the guard leg (for LV/RV instruments) defines what is called the “outer boundary” of the measurement. The spindle factors for the LV, RV, and HA/HB spindles were developed with the above boundary conditions. The spindle factors are used to convert the instrument torque (expressed as the dial reading or %Torque value) into centipoise. Theoretically, if measurements are made with different boundary conditions, e.g., without the guard leg or in a container other than 600 mL beaker, then the spindle factors found on the Factor Finder cannot be used to accurately calculate an absolute viscosity. Changing the boundary conditions does not change the viscosity of the fluid, but it does change how the instrument torque is converted to centipoise. Without changing the spindle factor to suit the new boundary conditions, the calculation from instrument torque to viscosity will be incorrect.

Practically speaking, the guard leg has the greatest effect when used with the #1 & #2 spindles of the LV and RV spindle sets (Note: RV/HA/HB #1 spindle is not included in standard spindle set). Any other LV (#63 & #64) or RV (#3 - #7) spindle can be used in a 600 mL beaker with or without the guard leg to produce correct results. The HA and HB series Viscometers/Rheometers are not supplied with guard legs in order to reduce the potential problems when measuring high viscosity materials. HA/HB spindles #3 through #7 are identical to those spindle numbers in the RV spindle set. The HA/HB #1 & #2 have slightly different dimensions than the corresponding RV spindles. This dimensional difference allows the factors between the RV and HA/HB #1 & #2 spindles to follow the same ratios as the instrument torque even though the boundary conditions are different.

The recommended procedures of using a 600 mL beaker and the guard leg are difficult for some customers to follow. The guard leg is one more item to clean. In some applications, the 500 mL of test fluid required to immerse the spindles in a 600 mL beaker is not available. In practice, a smaller vessel may be used and the guard leg is removed. The Brookfield AMETEK Viscometer/Rheometer will produce an accurate and repeatable torque reading under any measurement circumstance. However, the conversion of this torque reading to centipoise will only be correct if the factor used was developed for those specific conditions. Brookfield AMETEK has outlined a method for recalibrating a Brookfield AMETEK Viscometer/Rheometer to any measurement circumstance in More Solutions to Sticky Problems. It is important to note that for many viscometer users the true viscosity is not as important as a repeatable day to day value. This repeatable value can be obtained without any special effort for any measurement circumstance. But, it should be known that this type of torque reading will not convert into a correct centipoise value when using a Brookfield AMETEK factor if the boundary conditions are not those specified by Brookfield AMETEK.

The guard leg is a part of the calibration check of the Brookfield AMETEK LV and RV series Viscometer. Our customers should be aware of its existence, its purpose and the effect that it may have on data. With this knowledge, the viscometer user may make modifications to the recommended method of operation to suit their needs.

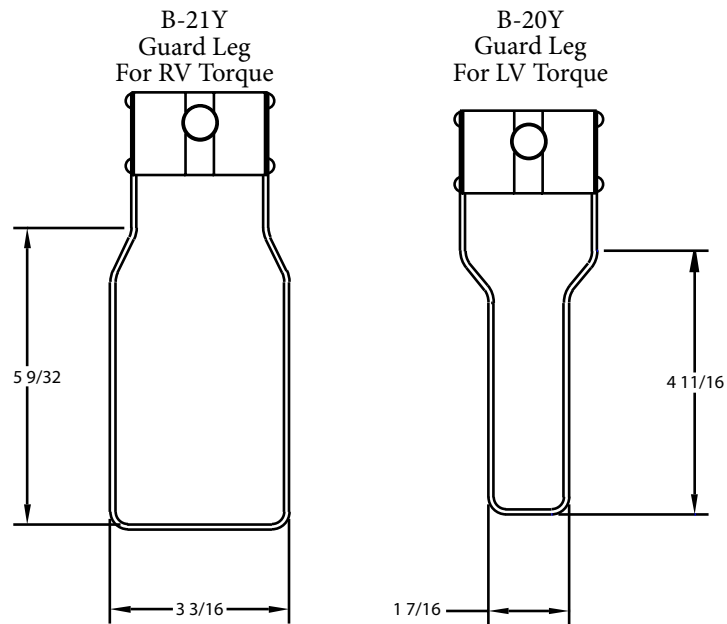
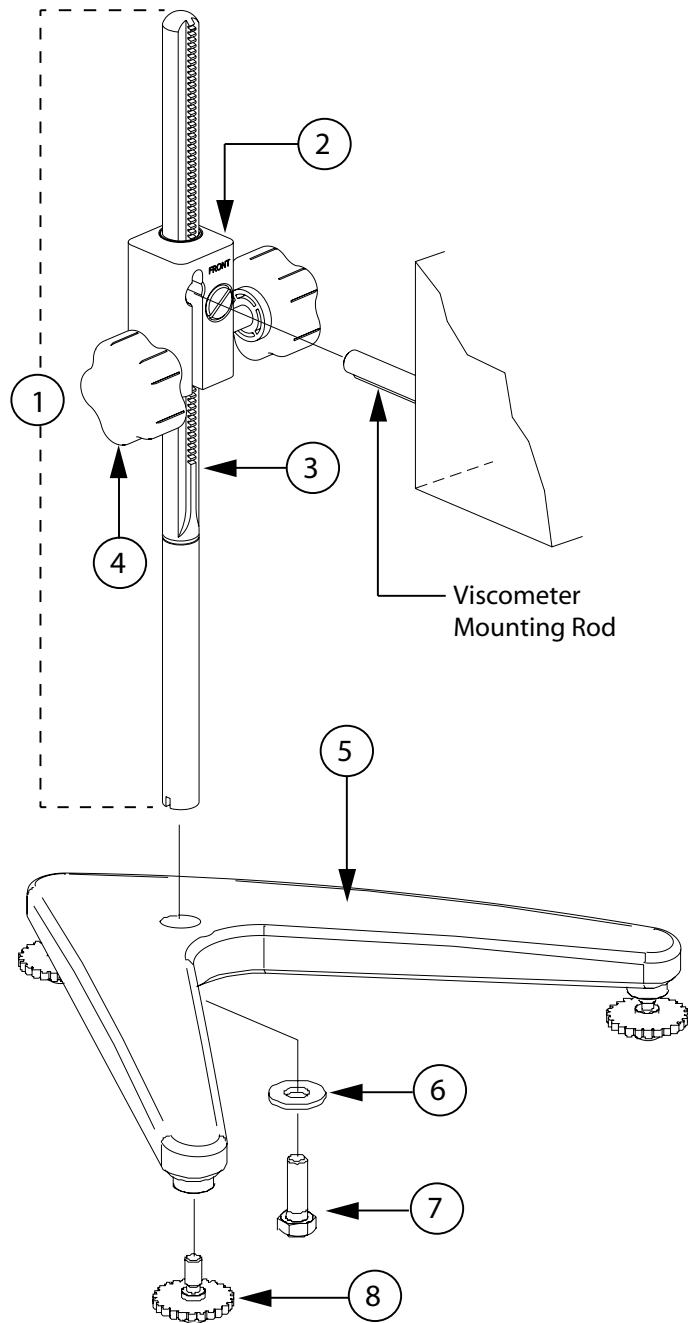

Figure F-1 - Brookfield AMETEK Guard Leg

Appendix G - Laboratory Stand with Parts Identification



Item	Part Number	Description	Qty
1	VS-CRA-14S	Rod and Clamp Assembly † *	1
2	N/A	Universal Lab Stand Clamp Assembly	1
3	N/A	14" Upright Rod *	1
4	VS-41Y	Knob Assembly	1
5	VS-1Y	Base, Model A (includes 3 VS-3 leveling screws)	1
6	502028071S33B	Flat washer 5/16 x 7/8 x .071"	1
7	50S311832S01B	Screw, 5/16-18 x 1" lg. slotted head	1
8	VS-3	Leveling Screws, Model A, S and Q	3

* Optional 18" rod available

N/A Not for individual purchase

† Includes screw and washer (Items 6 and 7)

Unpacking

Check carefully to see that all the components are received with no concealed damage.

1 base (VS-1Y)	1 screw and flat washer
3 leveling screws (VS-3)	1 clamp and rod assembly (VS-CRA-14S)

Open and discard all packaging materials for the base. Remove the three (3) leveling screws from the base. Remove the jam nut from the upright rod.

Assembly (Refer to Appendix E)

Screw the leveling screws into the base. Insert the threaded end of the upright rod into the hole in the top of the base and attach the jam nut to the rod on the underside of the base. With the clamp and rod assembly facing forward (the word “front” should be facing the operator), towards the open part of the “V” in the base, gently tighten the jam nut.

Viscometer Mounting

The VS-CRA-14S clamp and rod assembly should be positioned so that the word ‘front’ is facing the operator. This will ensure the cut-away slot of the clamp assembly will align properly with the machined key ridge of the viscometer handle. Insert the viscometer rod into the cut-away hole of the clamp assembly. Adjust the instrument level until the bubble is centered within the target and tighten the clamp knob.

The tension screw on the front side of the clamp assembly should be loosened or tightened as necessary to provide smooth height adjustment and adequate support for the Viscometer.

Center the Viscometer relative to the stand base and retighten the jam nut as required. Referring to the Viscometer bubble level, adjust the leveling screws until the instrument is level.

Operation

Rotate the Up/Down Knob to raise or lower the viscometer.

Appendix H - Fault Diagnosis and Troubleshooting

Spindle Does Not Rotate

- Make sure the power cord is plugged in and connected to the socket on the AV-6 power supply.
- Make sure the metal jack of the AV-6 power supply is firmly attached to the viscometer.
- Make sure the power is ON and that the motor is on (verified by rpm in display).

Spindle Wobbles When Rotating or Looks Bent

- Make sure the spindle is tightened securely to the viscometer coupling.
- Check the straightness of all other spindles; replace them if bent.
- Inspect viscometer coupling and spindle coupling mating areas and threads for dirt: clean threads on spindle coupling with a 3/56 left-hand tap.
- Inspect threads for wear; if the threads are worn, the unit needs service (see Appendix J).
- Check to see if spindles rotate eccentrically or wobble. There is an allowable run-out for 1/32-inch in each direction (1/16-inch total) when measured from the bottom of the spindle rotating in air.
- Check to see if the viscometer coupling is bent; if so, the unit is in need of service.

If you are continuing to experience problems with your viscometer, follow this troubleshooting section to help isolate the potential problem.

Dynamic Zero Test

- Remove spindle and level the viscometer.
- Set speed to 10 rpm and turn the motor on.

If the viscometer % torque is greater than $\pm 0.5\%$, a calibration check should be performed. See Appendix E for details on how to perform the calibration check procedure.

Inaccurate Readings

- Verify Spindle, Speed and Model selection
- Verify test parameters: temperature, container, volume, and method. Refer to:
 - “More Solutions to Sticky Problems”; Chapter 3, Section 3.4, Viscosity Measurement Techniques
- Perform a calibration check. Follow the instructions in Appendix E.
 - Verify tolerances are calculated correctly.
 - Verify that calibration check procedures were followed exactly.

If the unit is found to be out of tolerance, the unit may be in need of service. See Appendix J for details on how to return your viscometer.

Appendix I - Online Help and Additional Resources

www.brookfieldengineering.com**

The Brookfield AMETEK website is a good resource for additional information and self-help whenever you need it. Our website offers a selection of “how to” videos, application notes, conversion tables, instruction manuals, material safety data sheets, calibration templates and other technical resources.

<http://www.youtube.com/user/BrookfieldEng>

Brookfield AMETEK has its own YouTube channel. Videos posted to our website can be found here as well as other “home-made” videos made by our own technical sales group.

Viscosityjournal.com

Brookfield AMETEK is involved with a satellite website that should be your first stop in viscosity research. This site serves as a library of interviews with experts in the viscosity field as well as Brookfield AMETEK technical articles and conversion charts. Registration is required so that you can be notified of upcoming interviews and events, however, this information will not be shared with other vendors, institutions, etc.

Article Reprints

- Available in Print Only
- Brookfield AMETEK has an extensive library of published articles relating to viscosity, texture and powder testing. Due to copyright restrictions, these articles cannot be emailed. Please request a hardcopy of articles by calling our customer service department or by emailing: marketing@brookfieldengineering.com.
- Available Online
- Brookfield AMETEK has a growing number of published articles that can be downloaded directly from the Brookfield AMETEK website. These articles can be found on our main website by following this path: <http://www.brookfieldengineering.com/support/documentation/article-reprints>

More Solutions To Sticky Problems

Learn more about viscosity and rheology with our most popular publication. This informative booklet will provide you with measurement techniques, advice and much more. It's a must-have for any Brookfield AMETEK Viscometer or Rheometer operator. More Solutions is available in print and/or as a downloadable pdf on the Brookfield AMETEK website by following this path: <http://www.brookfieldengineering.com/support/documentation>

Training/Courses

Whether it is instrument-specific courses, training to help you better prepare for auditing concerns, or just a better understanding of your methods, who better to learn from than the worldwide leaders of viscosity measuring equipment? Visit our Services section on our website to learn more about training.

** Downloads will require you to register your name, company and email address. We respect your privacy and will not share this information outside of Brookfield AMETEK.

Appendix J - Warranty Repair and Service

Warranty

Brookfield AMETEK Viscometers are guaranteed for one year from date of purchase against defects in materials and workmanship. They are certified against primary viscosity standards traceable to the National Institute of Standards and Technology (NIST). The Viscometer must be returned to **Brookfield AMETEK** or the Brookfield AMETEK dealer from whom it was purchased for a warranty evaluation. Transportation is at the purchaser's expense. The Viscometer should be shipped in its carrying case together with all spindles originally provided with the instrument. If returning to Brookfield AMETEK, please contact us for a return authorization number prior to shipping. Failure to do so will result in a longer repair time.

*For a copy of the Repair Return Form, go to the Brookfield AMETEK website,
www.brookfieldengineering.com*

For repair or service in the **United States** return to:

Brookfield AMETEK
11 Commerce Boulevard
Middleboro, MA 02346 U.S.A.

Telephone: (508) 946-6200 Fax: (508) 923-5009
www.brookfieldengineering.com

For repair or service outside the United States consult AMETEK or the dealer from whom you purchased the instrument.

For repair or service in the **United Kingdom** return to:

AMETEK (GB) Limited
Brookfield Technical Centre
Stadium Way
Harlow, Essex CM19 5GX, England

Telephone: (44) 1279/451774 Fax: (44) 1279/451775
www.brookfield.co.uk

For repair or service in **Germany** return to:

AMETEK GmbH
Hauptstrasse 18
D-73547 Lorch, Germany

Telephone: (49) 7172/927100 Fax: (49) 7172/927105
www.brookfield-gmbh.de

For repair or service in **China** return to:

AMETEK Commercial Enterprise (Shanghai) Co., Ltd
Suite 905, South Tower, Xindacheng Plaza
193 Guangzhou Da Dao Bei, Yuexiu District
Guangzhou, 510075 P. R. China

Telephone: (86) 20/3760-0548 Fax: (86) 20/3760-0548
www.brookfield.com.cn

On-site service at your facility is also available from Brookfield AMETEK. Please contact our Service Department in the United States, United Kingdom, Germany or China for details.

