

Technical description

TempEvent T/180/70a/3



TempEvent T/180/70a/3 01.1E/04 2019

Illustration is similar, contains additional equipment

Test whatever you like.

Standards for Temperature Test Chambers

Low-temperature tests
IEC 60068-2-1, Test A
ISO 16750-4, Low-temperature test
ETSI EN 300019-2-4, Test Ab/Ad
MIL-STD-810 G, Meth. 502.5
JESD22-A119
High-temperature tests
IEC 60068-2-2, Test B
ISO 16750-4, High-temperature test
ETSI EN 300019-2-4, Test Bb/Bd
MIL-STD-202 G, Meth. 108A
MIL-STD-810 G, Meth. 501.5
MIL-STD-883 J, Meth. 1008.2
JESD22-A103D
Alternating temperature tests
IEC 60068-2-14, Test Nb
ISO 16750-4, Temp. steps
ISO 16750-4, Temp. cycling
ETSI EN 300019-2-4, Test Nb
MIL-STD-331 C, Test C6

The temperature values specified in the standards (severity levels) are limited by the highest and lowest test space temperature. The choice of the appropriate test system depends on the temperature change rates during alternating tests. The requirements are met if the test system capacity is large enough to compensate for the influence of the specimen and its heat dissipation in the relevant capacity range. Please contact us to test the feasibility with your test specimen.

The reference point for test values and tolerance specifications is the middle of the test space. Verifying documentation for individual test values is optionally available at additional cost.

Your standard is not listed? Contact us!

Sophisticated technology. Perfectly crafted.

The new era of environmental simulation.

The new era continues: With TempEvent, the latest generation of Temperature Test Chambers, you can now also test in extended temperature ranges in an environmentally friendly way - with even better performance down to $-55\text{ }^{\circ}\text{C}$, a range required by all current standards. We achieve this by using the new, environmentally friendly refrigerants R449A and R-469A (WT69) and thus guarantee maximum future safety for your device.

The new refrigerant R-469A (WT69) developed by **weisstechnik** replaces refrigerant R23, which was previously used in cascaded environmental simulation systems. This makes **weisstechnik** the first manufacturer in the world to offer an environmentally friendly and future-proof refrigerant alternative for high-performance tests at very low temperatures from $-40\text{ }^{\circ}\text{C}$ to $-70\text{ }^{\circ}\text{C}$, without having to compromise on reliability, safety and performance.



Illustration is similar, contains additional equipment

A secure future – thanks to refrigerant R-469A (WT69).

- **Secure investment:** With a GWP value of 1357, refrigerant R-469A (WT69) guarantees the trouble-free use of test chambers beyond 2030.
- **Powerful:** Test chambers operated with R-469A (WT69) improve the performance in the most important part of the temperature range and thus ensure constant and comparable test conditions.
- **Economical:** With a filling quantity of up to 3.6 kg, the annual leakage test prescribed by the EU F-gas regulation is not required.
- **Non-hazardous:** Refrigerant R-469A (WT69) was developed and tested in close cooperation with experienced partners. It is non-toxic and non-flammable.

Proven basis - refrigerant R449A.

For the temperature range down to $-40\text{ }^{\circ}\text{C}$, the proven and environmentally friendly refrigerant R449A is still used, as in all Temperature Test Chambers of series TempEvent. With a GWP value of 1397, it also meets the requirements of the EU F-Gas Regulation and enables safe, environmentally friendly operation of the test chambers - even beyond the year 2030!

Sophisticated technology. Perfectly crafted.

Less is more.

TempEvent comes equipped with **greenmode**[®]. With the use of **greenmode**[®], you can reduce your running costs and save up to 40% on electrical energy and, thus, many tons of CO₂. We are able to achieve these savings through intelligent control of system components under specific operating conditions.



Precise control.

SIMPAC[®], the measuring and control system for operation, monitoring and documentation, is a basic feature of Temperature Test Chambers TempEvent.

Entering the age of connectivity – with WEBSeason[®].

You can program, control and monitor your test at any time and anywhere with the innovative **WEBSeason**[®] user interface. **WEBSeason**[®] provides a new dimension of flexibility and efficiency.

- Modern and dynamic design with swipe control for intuitive operation
- Multi-user concept for simultaneous access by multiple users, user rights are assigned individually
- Easy programming of test sequences and loops
- Program preview in chart format
- Worldwide access, even via tablet PC and smartphone

Illustration is similar, contains additional equipment

TempEvent T/180/70a/3 01.1.E/04 2019

We reserve the right to make any technical changes without prior notice

Advanced technology. Reliable results.

PERFORMANCE DATA FOR TEMPERATURE TESTS		
Maximum temperature	°C	+180
Minimum temperature ¹	°C	-70
Rate of temperature change ² , cooling	K/min	3.8
Rate of temperature change ² , heating	K/min	4.0
Temperature deviation ³ , in time	K	±0.1 to ±0.5
Temperature homogeneity ⁴ , in space	K	±0.5 to ±1.0
Temperature gradient ⁵	K	≤2
Heat compensation ⁶ , max.	W	2000
Factory calibration values ⁷	°C	-40 and +80

¹ Temperatures >+5 °C are permitted in continuous operation; temperatures <+5 °C are permitted discontinuously or with the additional equipment "compressed air dryer".

² According to IEC 60068-3-5; average, measured in the supply air.

³ In the middle of the test space when it is empty and at steady state, without specimen, without heat radiation and without additional equipment, depending on temperature.

⁴ Relative to the selected set point in the temperature range from the minimum temperature up to +150 °C.

⁵ Up to +150 °C according to IEC 60068-3-5:2001 and/or JF 1101-2003.

⁶ At +20 °C.

⁷ The factory calibration of the temperature values is carried out with DAkkS-calibrated measuring equipment in the middle of the test space and documented with a certificate. A DAkkS calibration, as well as a spatial factory or a spatial DAkkS calibration, can be provided on request. DAkkS calibration is carried out by Vötsch Industrietechnik GmbH.

The performance data refers to +25 °C ambient temperature and +18 °C cooling water temperature, 400 V/50 Hz nominal voltage, without specimen, without additional equipment and without heat compensation.

The test chamber is designed for installation inside dry and ventilated spaces with max. degree of contamination "2" according to EN 50178:1997. The permissible ambient temperature during operation is between +10 °C and +35 °C. The max. permissible humidity must not exceed 75% RH and the max. dew point must not exceed +20 °C.

We reserve the right to make any technical changes without prior notice.

Advanced technology. Reliable results.

RATE OF TEMPERATURE CHANGE FOR COOLING AND HEATING¹

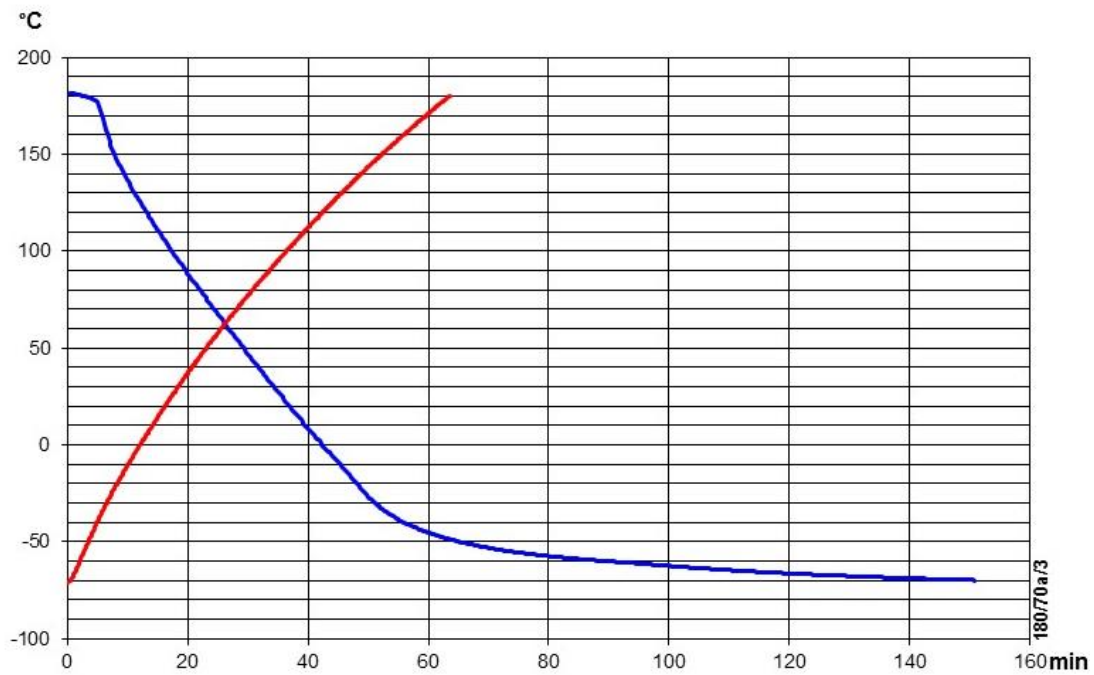

HEAT COMPENSATION²

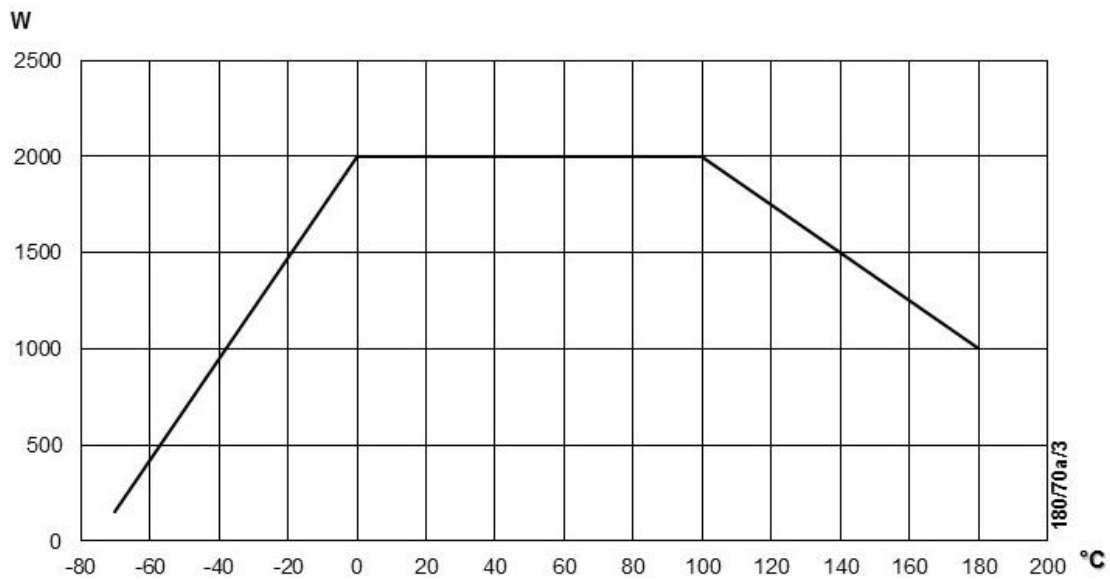

¹ Without test specimen, without heat radiation, measured at the control sensor in the supply air.

² Temperature measured at the control sensor in the supply air at steady state.

We reserve the right to make any technical changes without prior notice.

Technical data.

TECHNICAL DATA		
Test space volume	l	190
Test space dimensions, HxWxD	mm	750x580x450
Useable width	mm	540
Total load of multiple insertion shelves and test space floor ¹	kg	130
Load of the test space floor ¹	kg	50
Load per insertion shelf ¹	kg	30
Total load for multiple insertion shelves ¹	kg	80
Exterior housing dimensions, HxWxD	mm	1800x895x1495
Minimum exterior housing dimensions ² , HxWxD	mm	1700x800x1250
Total weight	kg	460
Voltage rating ³		3/N/PE AC 400 V ± 10% 50 Hz
Power rating ⁴	kW	4.9
Current rating ⁵	A	14
Connector		CEE connector, 16 A
Connection cable	m	3.5
Fuse protection ⁶	A, slow-blow	16
Protection class of switchgear cabinet and control unit ⁷		IP 54
Sound pressure level ⁸	dB(A)	57
Heat dissipation to the installation room, maximum	kW	4.7

¹ Max. load as surface load.

² For transport and move-in. Parts can be removed at additional expenses.

³ The test chamber can also be operated at 3/N/PE AC 380 V ± 10 % 50 Hz. In this case, the heating rate is reduced by approximately 10%.

⁴ The power rating quoted for **weisstechnik** and **vötschtechnik** products describes the maximum power consumption during operation at full load. As this state only occurs in rare cases, conclusions about energy consumption cannot be drawn from the power rating quoted.

⁵ Neutral conductor under load.

⁶ Provided by the customer.

⁷ EMC tests and information about emitted interference according to EN 61000-6-3:2007 / EN 61000-6-4:2007. Interference immunity is in accordance with EN 61000-6-2:2005.

⁸ Measured at a distance of 1 m from the front of the test chamber and a height of 1.6 m in free-field measurement according to EN ISO 11201:2010.

We reserve the right to make any technical changes without prior notice.

Technical data.

The Temperature Test Chamber is delivered ready for connection. The exterior housing is self-supporting.

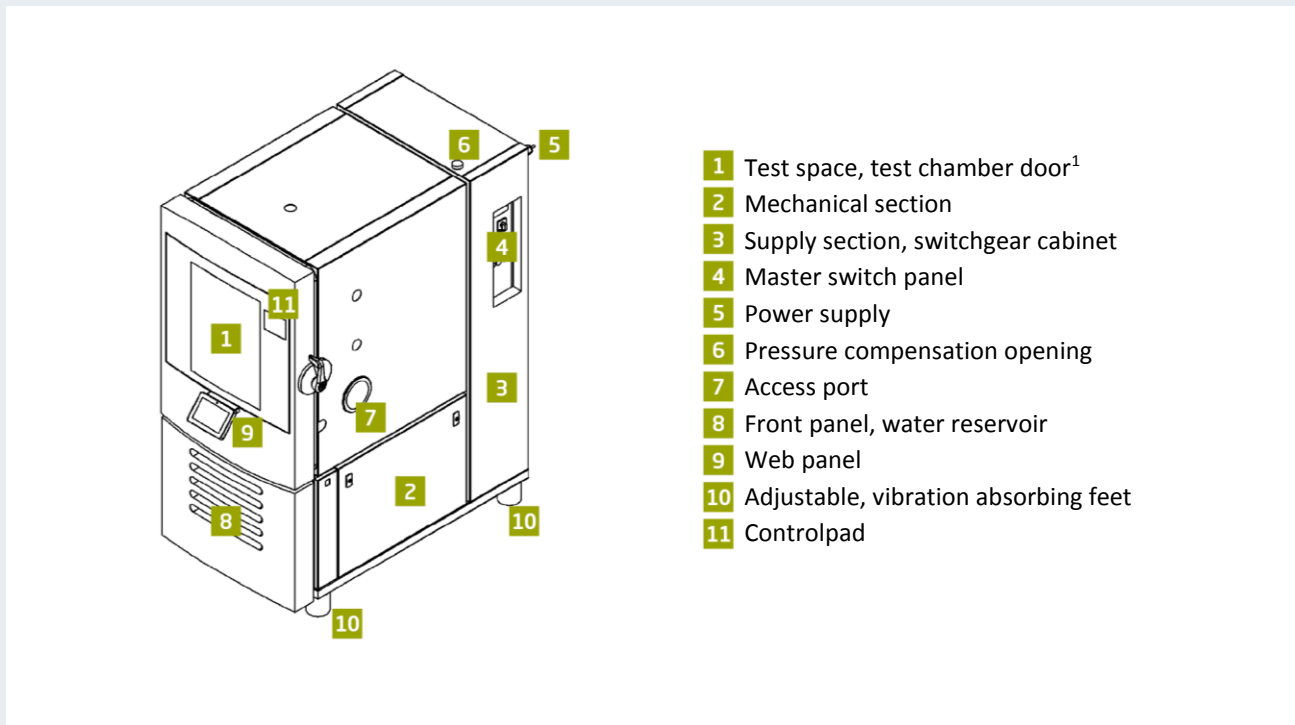

The supply and disposal connections are located on the rear side at the bottom, approx. 170 mm above floor level. The height of the "mobile version" (available as additional equipment) varies depending on the model; detailed values are included in the description of the additional equipment.

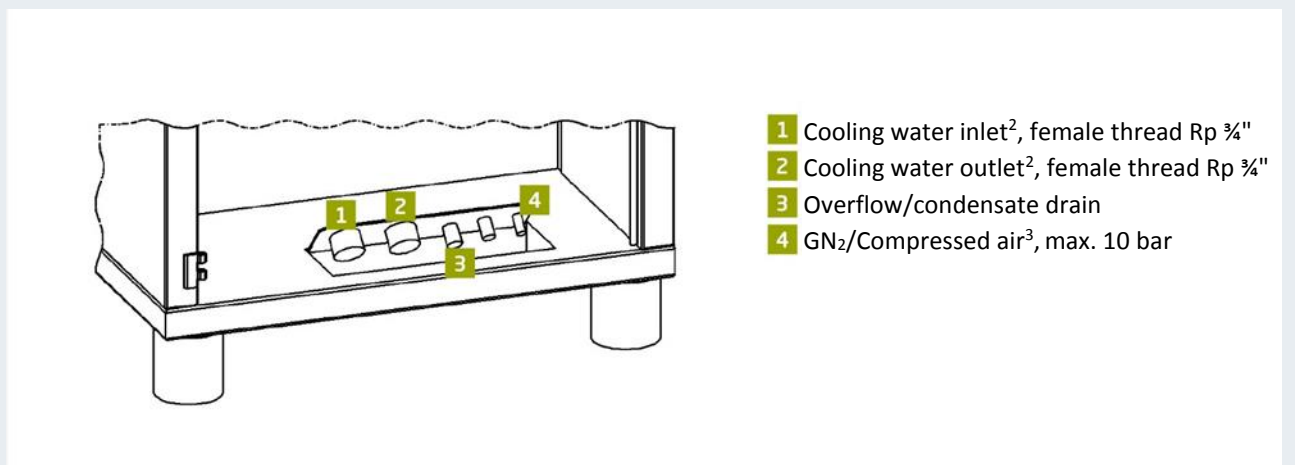

¹ Window is available as additional equipment.

² For water-cooled version (available as additional equipment).

³ Available as additional equipment.

We reserve the right to make any technical changes without prior notice.

Installation drawing.

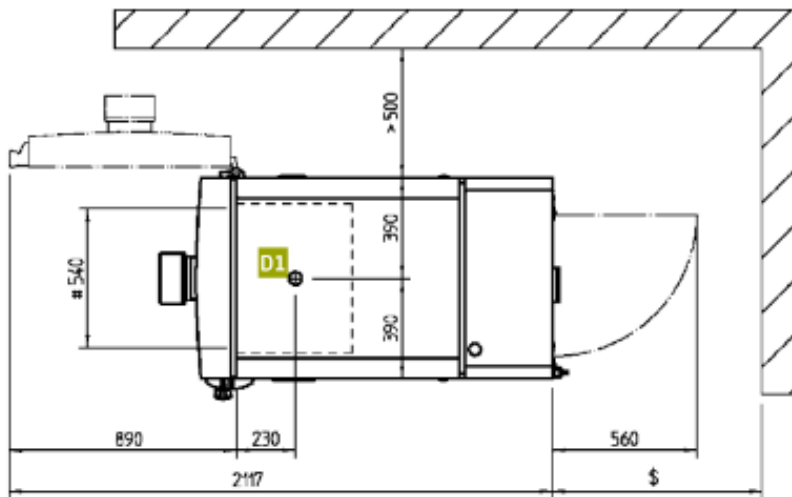
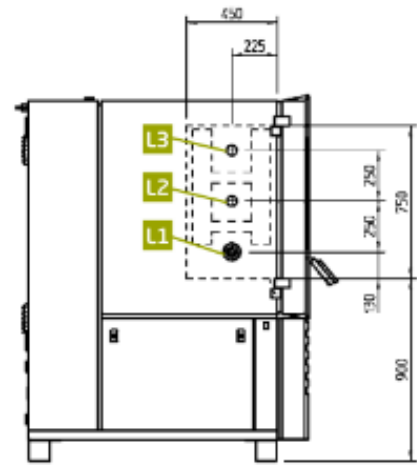
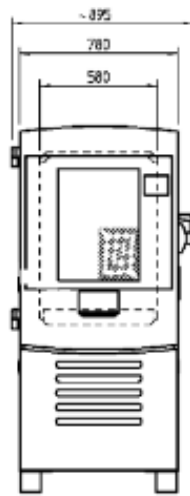
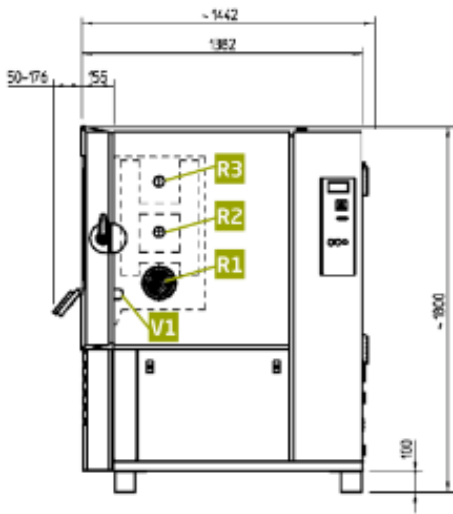

§: Min 200 mm, a wall distance of min. 700 mm is required for service work; according to IEC 60364-729 (VDE 100 part 729).

ACCESS PORTS

R1

Access port on the right side, \varnothing 125 mm

L1

Access port on the left side, \varnothing 50 mm

R2 R3 L2 L3

Additional installation positions, left and right¹

D1



Additional installation position, in the ceiling¹

V1

Notch port or flat notch port¹

¹ Available as additional equipment.

Our basic equipment.

EXTERIOR			
	Exterior housing	Material	Double-coated galvanized steel sheet
		Finish	RAL 9002 grey-white, solvent-free, powder-coated
	Door		Hinged on the left side, lockable, optimum contact pressure, one-handed operation
	Feet		Adjustable, vibration-absorbing
	Refrigeration unit ¹	Type	Air-cooled refrigeration system
		Refrigerant ²	R449A, GWP: 1397, filling quantity: 2.5 kg, CO ₂ equivalent: 3.5 t R-469A (WT69), GWP: 1357, filling quantity: 0.6 kg, CO ₂ equivalent: 0.81 t
Overflow / condensate drain		Backpressure-free, G ¾" male thread, hose connection Ø 12 mm	
INTERIOR			
	Test space ³	Wall material	Stainless steel 1.4301, surface III D polished shelf layers stamped on the side, vertical spacing ⁴ 60 mm
		Floor material	Stainless steel 1.4404, surface II B matt
	Insertion shelf	Stainless steel	1 pc., max. number of insertion shelves: 8
	Access ports	Stainless steel	1 pc. on the right, internal dimensions ⁵ 125 mm Ø
			1 pc. on the left, internal dimensions ⁵ 50 mm Ø
	Silicone plugs	Closed	1 pc. for each stainless steel access port, right and left (Ø 125 mm and 50 mm)
		Slotted	1 pc. for each stainless steel access port, right and left (Ø 125 mm and 50 mm)
	Measurement sensors	Temperature	Pt 100 platinum temperature sensor
Condensation protection	Dehumidifier	Can be switched on to avoid condensation on test specimen. This is achieved via separate dehumidifying coil.	

¹ The product contains fluorinated greenhouse gases.

² (EU) directive no. 517/2014 specifies an obligation for stationary refrigeration and air conditioning units with a CO₂ equivalent of 5 to 50 t to be checked for leaks at least annually and an equipment logbook to be kept; units with a leak detection system must be checked every 24 months. We can carry out these tasks for you in our capacity as an expert partner. We would be glad to advise you on installing a leak detection system.

³ The use of tempered silicone parts means that the test space produces only low emissions. If the test space has to be emissions-free, this requires technical clarification; please contact us to request an offer.

⁴ Tests must be set up at least 20 mm away from walls.

⁵ Production-related tolerances of up to ± 3 mm are possible.

We reserve the right to make any technical changes without prior notice.

Your additional equipment.