



**memmert**

Experts in Thermostatics

IPP  
IPS



## OPERATING INSTRUCTIONS

PELTIER-COOLED INCUBATOR IPP

STORAGE COOLED INCUBATOR IPS

**100% ATMOSAFE. MADE IN GERMANY.**

[www.memmert.com](http://www.memmert.com) | [www.atmosafe.net](http://www.atmosafe.net)

## Manufacturer and customer service

Memmert GmbH + Co. KG  
Willi Memmert Straße 90-96  
D-91186 Büchenbach  
Deutschland

Phone: +49 (0)9122 925-0  
Fax: +49 (0)9122 14585  
E-mail: [sales@memmert.com](mailto:sales@memmert.com)  
Internet: [www.memmert.com](http://www.memmert.com)

### Customer service:

Service hotline: +49 (0)9171 9792 911  
Service fax: +49 (0)9171 9792 979  
E-mail: [service@memmert.com](mailto:service@memmert.com)

When contacting customer service, always quote the product serial number on the nameplate (see page 12).

### Shipping address for repairs:

Memmert GmbH + Co. KG  
Kundenservice  
Willi-Memmert-Str. 90-96  
DE-91186 Büchenbach  
Germany

Please contact our customer service before sending appliances for repair or before returning equipment, otherwise, we have to refuse acceptance of the shipment.

© 2015 MEMMERT GmbH + Co. KG

D24034 | Date 06/2016

We reserve the right to make changes

## About this manual

---

### Purpose and target group

This manual describes the assembly, function, transport and operation of Peltier incubators IPP and cooled storage incubators IPS. It is intended for use by trained personnel of the owner, who have the task of operating and/or maintaining the respective appliance.

If you are asked to work on the appliance, read this manual carefully before starting. Familiarise yourself with the safety regulations. Only perform work that is described in this manual. If there is something you do not understand, or certain information is missing, ask your superior or contact the manufacturer. Do not do anything without authorisation.

### Versions

The appliances are available in different configurations and sizes. If specific equipment features or functions are available only for certain configurations, this is indicated at the relevant points in this manual.

The functions described in this manual refer to the latest firmware version.

Due to individual configurations and sizes, illustrations in this manual may be slightly different from the actual appearance. Function and operation are identical.

### Other documents that have to be observed:

- ▶ For operation of the appliance with MEMMERT AtmoCONTROL, observe the separate software manual
- ▶ For service and repair work (see page 40), observe the separate service manual

### Storage and resale

This instruction manual belongs with the appliance and should always be stored where persons working on the appliance have access to it. It is the responsibility of the owner to ensure that persons who are working or will work on the appliance are informed as to the whereabouts of this instruction manual. We recommend that it is always stored in a protected location close to the appliance. Make sure that the instruction manual is not damaged by heat or humidity. If the appliance is sold on or transported and then set up again at a different location, the operating instructions must go with it.

You will find the current version of our operating manual as pdf file if you go to [www.memmert.com/de/service/downloads/bedienungsanleitung/](http://www.memmert.com/de/service/downloads/bedienungsanleitung/).

# Contents

---

<b>1. For your Safety</b>	<b>6</b>
1.1 Terms and signs used.....	6
1.1.1 Terms used .....	6
1.1.2 Signs used .....	6
1.2 Product safety and dangers .....	7
1.3 Requirements of the operating personnel .....	7
1.4 Responsibility of the owner.....	8
1.5 Intended use.....	8
1.6 Changes and conversions.....	8
1.7 Behaviour in case of malfunctions and irregularities.....	9
1.8 Switching off the appliance in an emergency .....	9
<b>2. Construction and description</b>	<b>10</b>
2.1 Construction .....	10
2.2 Description.....	11
2.3 Material.....	11
2.4 Electrical equipment.....	11
2.5 Connections and interfaces.....	11
2.5.1 Electrical connection .....	11
2.5.2 Ethernet interface.....	12
2.6 Designation (nameplate).....	12
2.7 Technical data .....	13
2.8 Applied directives and standards .....	14
2.9 Declaration of conformity .....	14
2.10 Ambient conditions.....	15
2.11 Scope of delivery .....	15
2.12 Optional accessories .....	15
<b>3. Delivery, transport and setting up</b>	<b>16</b>
3.1 Safety regulations.....	16
3.2 Delivery .....	17
3.3 Transport.....	17
3.4 Unpacking .....	17
3.4.1 Checking for completeness and transport damage .....	17
3.4.2 Removing the transport protection .....	17
3.4.3 Disposing of packaging material .....	17
3.5 Storage after delivery .....	17
3.6 Setting up .....	18
3.6.1 Prerequisites .....	18
3.6.2 Installation options .....	19
3.6.3 Tilt protection.....	20
3.6.4 Adjusting the doors (only for model size 750).....	21
<b>4. Putting into operation</b>	<b>22</b>
4.1 Connecting the appliance .....	22

4.2	Switching on.....	22
<b>5.</b>	<b>Operation and control</b>	<b>23</b>
5.1	Operating personnel.....	23
5.2	Opening the door.....	23
5.3	Loading the appliance.....	24
5.4	Operating the appliance.....	25
5.4.1	ControlCOCKPIT .....	25
5.4.2	Basic operation.....	25
5.4.3	Adjustment options .....	26
5.4.4	Operation with digital backwards counter with target time setting, adjustable from 1 minute to 99 days (Timer).....	26
5.5	Temperature monitoring .....	28
5.5.1	Function .....	28
5.6	Ending operation.....	28
<b>6.</b>	<b>Malfunctions, warning and error messages</b>	<b>29</b>
6.1	Warning messages of the monitoring function.....	29
6.2	Malfunctions, operating problems and appliance errors .....	29
6.3	Power failure.....	30
<b>7.</b>	<b>Menu mode</b>	<b>31</b>
7.1	Overview.....	31
7.2	Basic operation in menu mode using the example of language selection.....	32
7.3	Setup.....	33
7.3.1	IP address .....	33
7.3.2	Unit.....	35
7.3.3	Timer mode .....	35
7.3.4	Type of the slide-in unit (Grid or Shelf) .....	35
7.3.5	Temperature monitoring.....	35
7.3.6	Remote control .....	36
7.3.7	Gateway .....	36
7.4	Date and Time .....	36
7.5	Calibration .....	38
<b>8.</b>	<b>Maintenance and service</b>	<b>40</b>
8.1	Cleaning.....	40
8.1.1	Working chamber and metal surfaces.....	40
8.1.2	Plastic parts .....	40
8.1.3	Glass surfaces.....	40
8.1.4	Peltier cooling module .....	40
8.2	Regular maintenance.....	41
8.3	Repairs and service .....	41
<b>9.</b>	<b>Storage and disposal</b>	<b>42</b>
9.1	Storage .....	42
9.2	Disposal .....	42
	<b>Index</b>	<b>43</b>

# 1. For your Safety

## 1.1 Terms and signs used

In this manual and on the appliance itself, certain common terms and signs are used to warn you of possible dangers or to give you hints that are important in avoiding injury or damage. Observe and follow these hints and regulations to avoid accidents and damage. These terms and signs are explained below.

### 1.1.1 Terms used

**"Warning"** is used whenever you or somebody else could be injured if you do not observe the accompanying safety regulation.

**"Caution"** is used for information that is important for avoiding damage.

### 1.1.2 Signs used

Warning signs (warning of a danger)				
Danger of electrocution	Danger of explosion	Dangerous gases / vapours	Danger of toppling over	Hazard area! Observe the operating instructions
Prohibition signs (forbidding an action)				
Do not lift	Do not tilt	Do not enter		
Regulation signs (stipulating an action)				
Disconnect the mains plug	Wear gloves	Wear safety boots	Observe information in separate manual	
Other icons				
	Important or useful additional information			

## 1.2 Product safety and dangers

The appliances described in this manual are technically sophisticated, manufactured using high-quality materials and subject to many hours of testing in the factory. They contain the latest technology and comply with recognised technical safety regulations. However, there are still risks involved, even when the appliances are used as intended. These are described below.



### Warning!

After removing covers, live parts may be exposed. You may receive an electric shock if you touch these parts. Disconnect the mains plug before removing any covers. Only electrical technicians may work on the electrical equipment of the appliances.

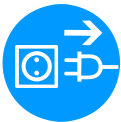

### Warning!

When loading the appliance with an unsuitable load, poisonous or explosive vapours or gases may be produced. This could cause the appliance to explode, and persons could be severely injured or poisoned. The appliance may only be loaded with materials/test objects which do not form any toxic or explosive vapours when heated up (see also chapter Intended use on page 8).



### Warning!

If the door is open while the appliance is in operation, the appliance may overheat and pose a fire hazard. Do not leave the door open during operation.



### Warning!

In case of appliances of a certain size, you can get accidentally locked in, which is life-threatening. Do not climb into the appliance!

## 1.3 Requirements of the operating personnel

The appliance may only be operated and maintained by persons who are of legal age and have been instructed accordingly. Personnel who are to be trained, instructed or who are undergoing general training may only work with the appliance under the continuous supervision of an experienced person.

Repairs may only be performed by qualified electricians. The regulations in the separate service manual must be observed.

## 1.4 Responsibility of the owner

The owner of the appliance

- ▶ is responsible for the flawless condition of the appliance and for it being operated in accordance with its intended use (see page 8);
- ▶ is responsible for ensuring that persons who are to operate or service the appliance are qualified to do this, have been instructed accordingly and are familiar with the operating instructions at hand;
- ▶ must know about the applicable guidelines, requirements and operational safety regulations, and train staff accordingly;
- ▶ is responsible for ensuring that unauthorised persons have no access to the appliance;
- ▶ is responsible for ensuring that the maintenance plan is adhered to and that maintenance work is carried out properly (see page 40);
- ▶ has to ensure that the appliance and its surroundings are kept clean and tidy, for example through corresponding instructions and inspections;
- ▶ is responsible for ensuring that personal protective clothing is worn by operating personnel, e.g. work clothes, safety shoes and protective gloves.

## 1.5 Intended use

- ▶ Peltier-cooled incubators IPP are intended for the storage of substances and samples, for determination of life expectancy as well as for cultivation and incubation in a temperature range of 0 to 70 °C.
- ▶ Cooled storage incubators IPS are intended for the storage and cooling of substances and samples and for determination of life expectancy at constant temperatures in a range of 14 to 45 °C.

Any other use could be dangerous.

The appliance is not explosion-proof (does not comply with the German workplace health & safety regulation VBG 24). The appliance may only be loaded with materials and substances which cannot form any toxic or explosive vapours at the set temperature and which cannot explode, burst or ignite.

The appliance may not be used for drying, vaporising and branding paints or similar materials the solvents of which could form an explosive mixture when combined with air. If there is any doubt as to the composition of materials, they must not be loaded into the appliance. Potentially explosive gas-air mixtures must not form, neither in the working chamber nor in the direct vicinity of the appliance.

## 1.6 Changes and conversions

No unauthorised changes or alterations may be made to the appliance. No parts may be added or inserted which have not been approved by the manufacturer.

Unauthorised changes or alterations result in the CE declaration of conformity losing its validity, and the appliance may no longer be operated.

The manufacturer is not liable for any damage, danger or injuries that result from unauthorised changes or alterations, or from non-observance of the regulations in this manual.



## 1.7 Behaviour in case of malfunctions and irregularities

The appliance may only be used in a flawless condition. If you as the operator notice irregularities, malfunctions or damage, immediately take the appliance out of service and inform your superior.

**i** You can find information on eliminating malfunctions from page 29.

## 1.8 Switching off the appliance in an emergency

Press the main switch at the ControlCOCKPIT (Fig. 1) and disconnect power plug. This disconnects the appliance from the power supply at all poles.

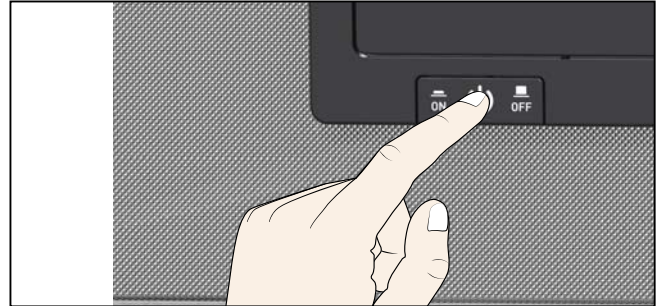

*Fig. 1*  
Switch off the appliance by pressing the main switch

## 2. Construction and description

### 2.1 Construction



Fig. 2 Construction

- 1 ControlCOCKPIT with capacitive function keys and LCD displays (see page 25)
- 2 On/Off switch (see page 22)
- 3 Chamber fan
- 4 Steel grid

- 5 Interior
- 6 Nameplate (see page 12)
- 7 Door handle
- 8 Turn control with confirmation key

## 2.2 Description

The appliance can heat the working chamber up to 70 °C (IPP) or 45 °C (IPS) and cool it down to 0 °C (IPP) or 14 °C (IPS). Low-noise, long-life and energy-saving Peltier cooling and heating technology is used for this. In heating operation, a part of the required energy is extracted from the surroundings (heat pump principle). Condensation formation during the cooling down process takes place outside the working chamber on the Peltier element

Optionally, the appliance can be equipped with a light module.

## 2.3 Material

For the outer housing, MEMMERT deploys stainless steel (Mat.No. 1.4016 – ASTM 430) and for the interior, stainless steel (Mat.No. 1.4301 – ASTM 304) is used, which stands out through its high stability, optimal hygienic properties and corrosion resistance to many (but not all!) chemical compounds (caution for example with chlorine compounds).

The chamber load for the appliance must be carefully checked for chemical compatibility with the materials mentioned. A material resistance table can be requested from the manufacturer.

## 2.4 Electrical equipment

- ▶ Operating voltage and current consumption: See nameplate
- ▶ Protection class I, i.e. operating insulation with PE conductor in accordance with EN 61010
- ▶ Protection type IP 20 acc. to EN 60 529
- ▶ Interference suppression acc. to EN 55011 class B
- ▶ Appliance fuse: Safety fuse 250 V/15 A, quick-blow
- ▶ The temperature controller is protected with a miniature fuse 100 mA (160 mA at 115 V)

## 2.5 Connections and interfaces

### 2.5.1 Electrical connection

This appliance is intended for operation on an electrical power system with a system impedance  $Z_{\max}$  of a maximum of 0.292 ohm at the point of transfer (service line). The operator must ensure that the appliance is operated only on an electrical power system that meets these requirements. If necessary, you can ask your local energy supply company what the system impedance is.

Observe the country-specific regulations when connecting (e.g. in Germany DIN VDE 0100 with residual current circuit breaker).

### 2.5.2 Ethernet interface

The Ethernet interface is intended for appliances which meet the requirements of IEC 60950-1.

Via Ethernet interface, the appliance can be connected to a network to read out protocol logs with the AtmoCONTROL software. The Ethernet interface is located on the rear of the appliance (Fig. 3).

For identification purposes, each appliance connected must have its own unique IP address. Setting the IP address is described on page 33.

With an optional USB to Ethernet converter, the appliance can be directly connected to a computer / laptop (see Optional accessories on page 15).

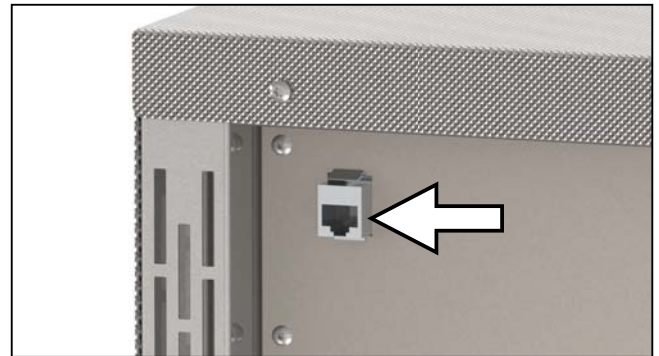

Fig. 3 Ethernet interface

### 2.6 Designation (nameplate)

The nameplate (Fig. 4) provides information about the appliance model, manufacturer and technical data. It is attached to the front of the appliance, on the right behind the door (see page 10).

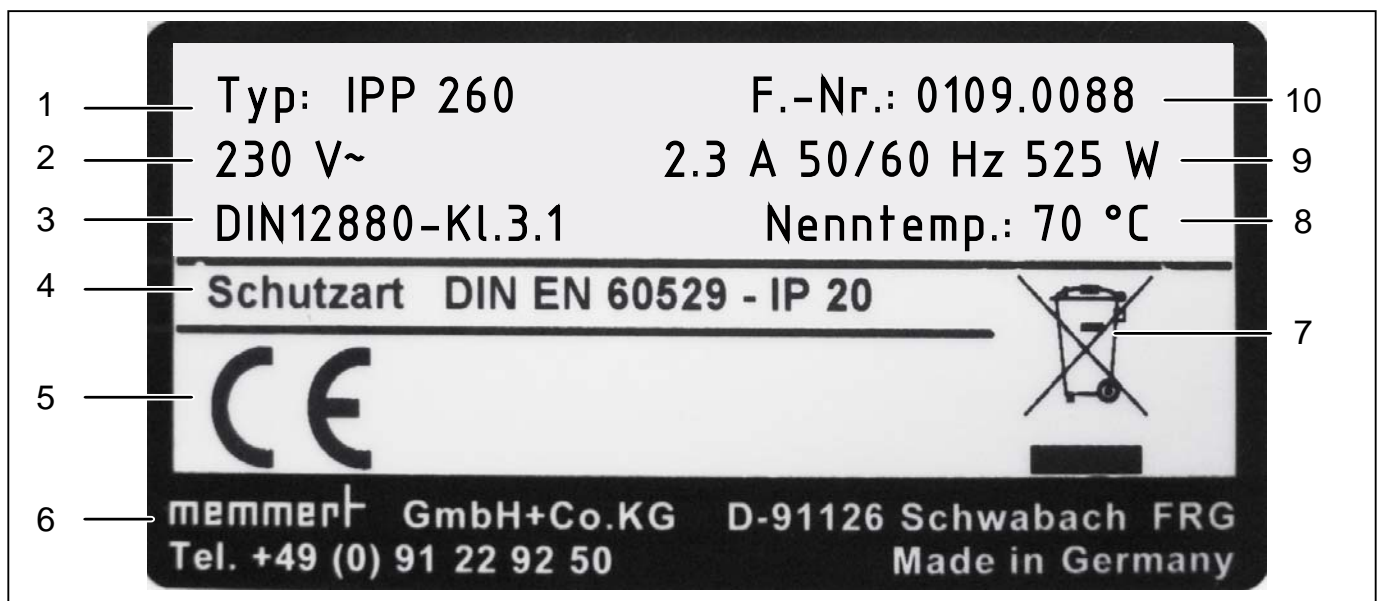

Fig. 4 Nameplate (example)

- |   |                     |    |                            |
|---|---------------------|----|----------------------------|
| 1 | Type designation    | 6  | Address of manufacturer    |
| 2 | Operating voltage   | 7  | Disposal note              |
| 3 | Applicable standard | 8  | Nominal temperature:       |
| 4 | Protection type     | 9  | Connection / power ratings |
| 5 | CE conformity       | 10 | Appliance number           |

## 2.7 Technical data

Appliance	IPP					IPS		
Appliance size	30	55	110	260	750	260	750	
Appliance width D <sup>1</sup> [mm]	585	585	745	824	1224	824	1224	
Appliance height E <sup>1</sup> [mm]	707	787	867	1186	1726	1186	1726	
Appliance depth G <sup>1</sup> (footprint) [mm]	524	604	674	774	874	774	874	
Depth of door lock [mm]	56							
Appliance depth F <sup>1</sup> (including door handle) [mm]	580	660	730	830	930	830	930	
Chamber width A <sup>1</sup> [mm]	400	400	560	640	1040	640	1040	
Chamber height B <sup>1</sup> [mm]	320	400	480	800	1200	800	1200	
Chamber depth C <sup>1</sup> [mm]	250	330	400	500	600	500	600	
Chamber volume [litres]	32	53	108	256	749	256	749	
Weight [kg]	62	74	100	121	284	114	256	
Power [W]	160	275	650	820	1200	550	550	
Current consumption [A]	230 V, 50/60 Hz	0.6	1.2	2.8	3.6	5.2	2.4	2.4
	115 V, 50/60 Hz	1.2	2.4	5.7	7.1	10.4	4.8	4.8
max. number of sliding shelves	3	4	5	9	14	9	14	
max. load per sliding shelf [kg]	20				30	20	30	
max. load per appliance [kg]	60	80	150	200	200	300	300	
Temperature	Adjustment range	0 to 70 °C <sup>2</sup>				14 to 45 °C <sup>2</sup>		
	Adjustment precision	0.1 K						

<sup>1</sup> see Fig. 5

<sup>2</sup> The minimum temperature depends on the outside temperature (see ambient conditions on page 15). If the interior is illuminated, the temperature range is further restricted.

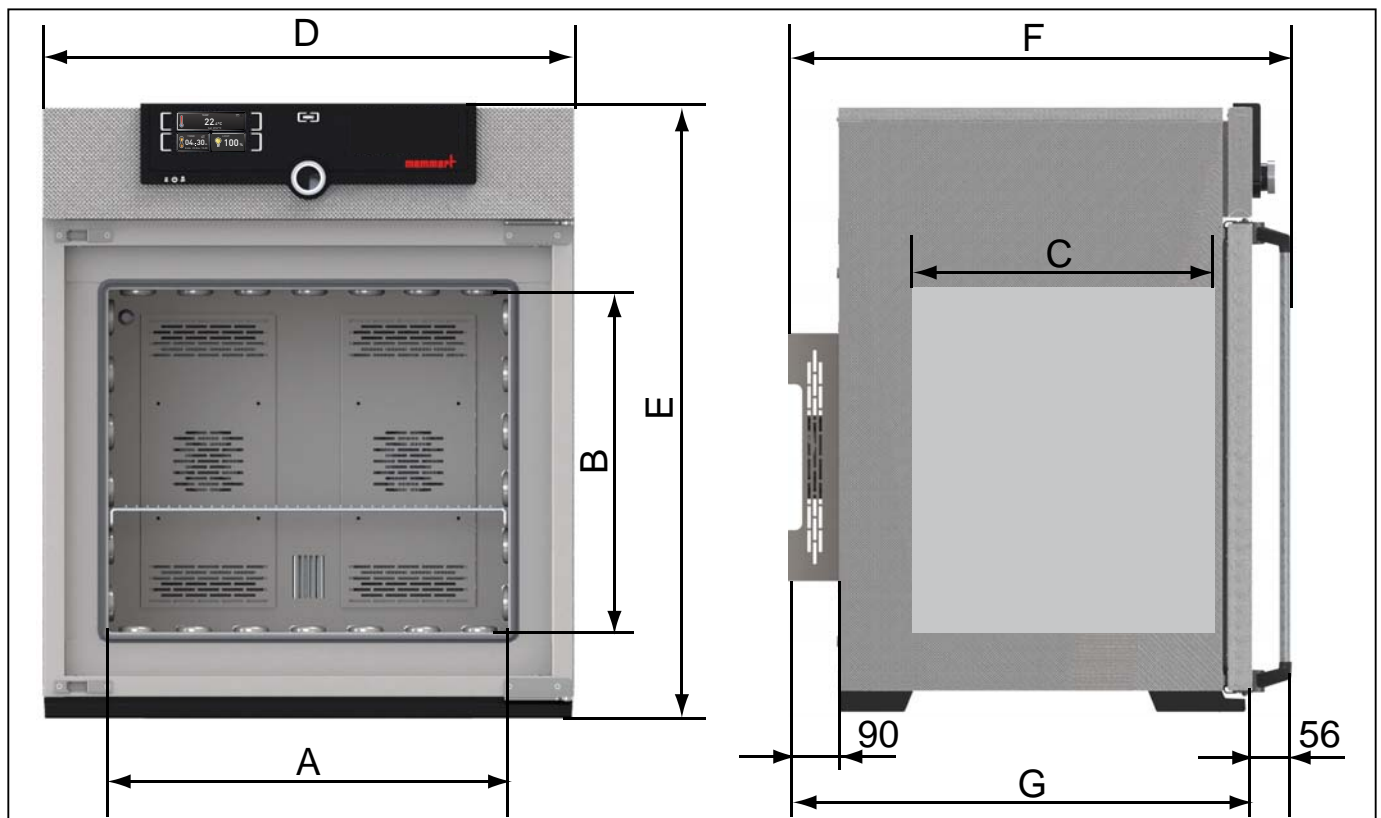

Fig. 5 Dimensions

## 2.8 Applied directives and standards

- ▶ Directive 2004/108/EC amended (Directive of the council on harmonisation of the laws of the member states on electromagnetic compatibility). Fulfilled standards:  
DIN EN 61326:2004-05, EN 61326:1997, EN 61326/A1:1998, EN 61326/A2:2001  
EN 61326/A2:2003
- ▶ Directive 2006/95/EC amended (Directive of the council on harmonisation of the laws of member states relating to electrical equipment designed for use within certain voltage limits). Standards complied with:  
DIN EN 61 010-1 (VDE 0411 Part 1):2002-08  
DIN EN 61 010-2-010 (VDE 0411 Part 2-010):2004-06  
EN 61 010-1:2001, EN 61 010-2-010:2003

## 2.9 Declaration of conformity

You can download the EC declaration of conformity of the appliance online:

English: <http://www.memmert.com/en/service/downloads/ce-statement/>

German: <http://www.memmert.com/de/service/downloads/eg-konformitaetserklaerung/>



## 2.10 Ambient conditions

- ▶ The appliance may only be used in enclosed areas and under the following ambient conditions:

Ambient temperature	IPP: 16 °C to 40 °C IPS: 16 °C to 28 °C
Humidity rh	max. 70 %, non-condensing
Overvoltage category	II
Pollution degree	2
Altitude of installation	max. 2,000 m above sea level

- ▶ The appliance may not be used in areas where there is a risk of explosion. The ambient air must not contain any explosive dusts, gases, vapours or gas-air mixtures. The appliance is not explosion-proof.
- ▶ Heavy dust production or aggressive vapours in the vicinity of the appliance could lead to sedimentation in the interior and, as a consequence, could result in short circuits or damage to electrical parts. For this reason, sufficient measures to prevent large clouds of dust or aggressive vapours from developing should be taken.

## 2.11 Scope of delivery

- ▶ Power cable
- ▶ Tilt protection
- ▶ Sliding grid (load capacity 30 kg each)
- ▶ The operating instructions at hand
- ▶ Calibration certificate
- ▶ For certain appliance sizes, separately packaged fastening material for wall mounting

## 2.12 Optional accessories

- ▶ USB to Ethernet converter (Fig. 6). Makes it possible to connect the appliance's network interface (see page 12) to the USB port of a computer / laptop.
- ▶ Reinforced, sliding steel grids with a load capacity of 60 kg each (for appliance size 110 and larger)

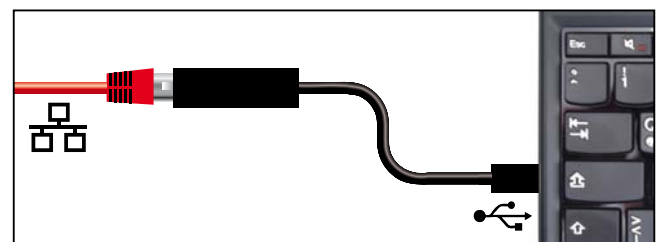

Fig. 6 Converter USB to Ethernet

### 3. Delivery, transport and setting up

#### 3.1 Safety regulations



**Warning!**

Because of the heavy weight of the appliance, you could injure yourself if you try to lift it. To carry appliances of the sizes 30 and 55, at least two persons, for appliances of the sizes 110 and 260, four persons are needed. Appliances larger than that may not be carried but must be transported with a manual pallet jack or forklift truck.

30	55	110	260	750



**Warning!**

You may get your hands or feet squashed when transporting and installing the appliance. Wear protective gloves and safety boots. When grasping the bottom of the appliance, grasp it only on the sides:



**Warning!**

The appliance could fall over and seriously injure you. Never tilt the appliance and transport it in upright position and without load only (except for standard accessories such as steel grids or shelves). Appliances with castors always have to be moved by two people.



## 3.2 Delivery

The appliance is packed in cardboard and is delivered on a wooden pallet.

## 3.3 Transport

The appliance can be transported in three ways:

- ▶ With a forklift truck; move the forks of the truck entirely under the pallet.
- ▶ On a manual pallet jack
- ▶ On its own castors, in case of the corresponding configuration, for which the catch on the (front) castors must be released

## 3.4 Unpacking

**i** To avoid damage, do not unpack the appliance until you reach the installation site.

Remove the cardboard packaging by pulling it upwards or carefully cutting along an edge.

### 3.4.1 Checking for completeness and transport damage

- ▶ Check the delivery note to ensure that the delivery is complete.
- ▶ Check the appliance for damage.

If you notice deviations from the delivery note, damage or irregularities, do not put the appliance into operation but inform the haulage company and the manufacturer.

### 3.4.2 Removing the transport protection

Remove the transport protection. It is located between the door hinge, door and frame and has to be removed after opening the door.

### 3.4.3 Disposing of packaging material

Dispose of the packaging material (cardboard, wood, foil) in accordance with the applicable disposal regulations for the respective material in your country.

## 3.5 Storage after delivery

If the appliance is first to be stored after delivery: Read the storage conditions from page 42.

## 3.6 Setting up



### Warning!

Due to its centre of gravity, the appliance can fall over to the front and injure you or other people. Always attach the appliance to a wall with the tilt protection (see page 20). If this cannot be done due to space problems, do not operate the appliance and do not open the door. Contact the Memmert service team (see page 2).

### 3.6.1 Prerequisites

The installation site must be flat and horizontal and must be able to reliably bear the weight of the appliance (see Technical data on page 13). Do not place the appliance on a flammable surface.

Depending on the model (see nameplate), a 230 V or 115 V power connection must be available at the installation site.

The distance between the wall and the rear of the appliance must be at least 15 cm. The clearance from the ceiling must not be less than 20 cm and the side clearance from walls or nearby appliances must not be less than 5 cm (Fig. 7). Sufficient air circulation in the vicinity of the appliance must be guaranteed at all times.

For appliances with castors, these need to be positioned in forward direction at all times.

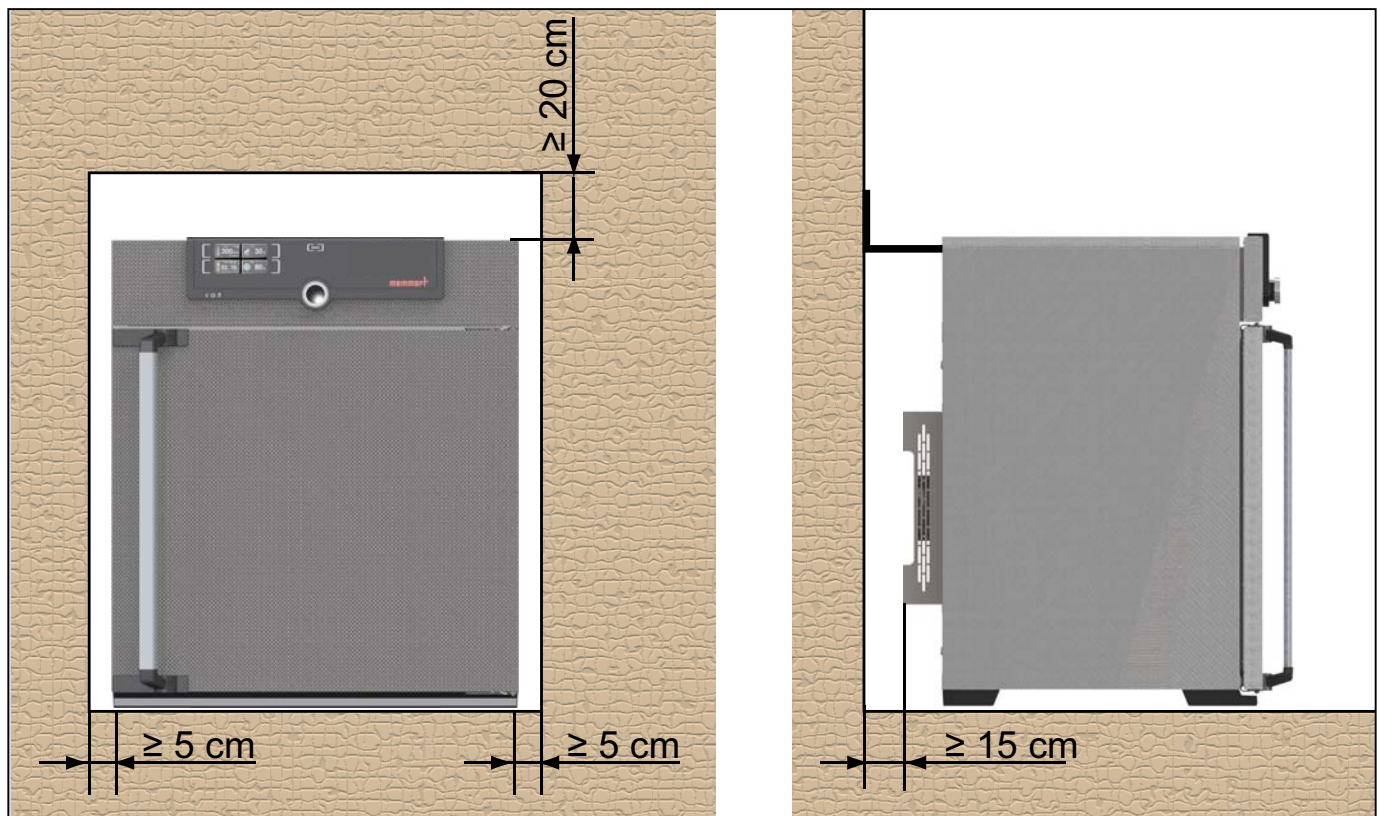



Fig. 7 Minimum clearance from walls and ceiling

**3.6.2 Installation options**

Setting up	Comments	Suitable for appliance size ...				
		30	55	110	260	750
<b>Floor</b> 		✓	✓	✓	✓	✓
<b>Table</b> 	Check the load capacity first	✓	✓	✓	✗	✗
<b>Stacked</b> 	Two appliances maximum; mounting material (feet) provided	✓	✓	✓	✗	✗
<b>Wall mounting</b> 	Separately packaged fastening material is included in the scope of delivery. Observe the assembly instructions provided.	✓	✓	✓	✗	✗
<b>Base</b> 	With/without castors	✓	✓	✓	✓	✗
<b>Castor frame</b> 		✓	✓	✓	✓	✗
<b>Height adjustable feet</b> 		✓	✓	✓	✓	✓

### 3.6.3 Tilt protection

Attach the appliance to a wall with the tilt protection. The tilt protection is included in the delivery.

1. As illustrated, fasten the tilt protection to the rear side of the appliance.
2. Bend the tilt protection upwards by 90 ° in the desired distance to the wall (consider the minimum distance to the wall, see Fig. 7).
3. Drill a hole, insert a plug and screw the tilt protection to a suitable wall.

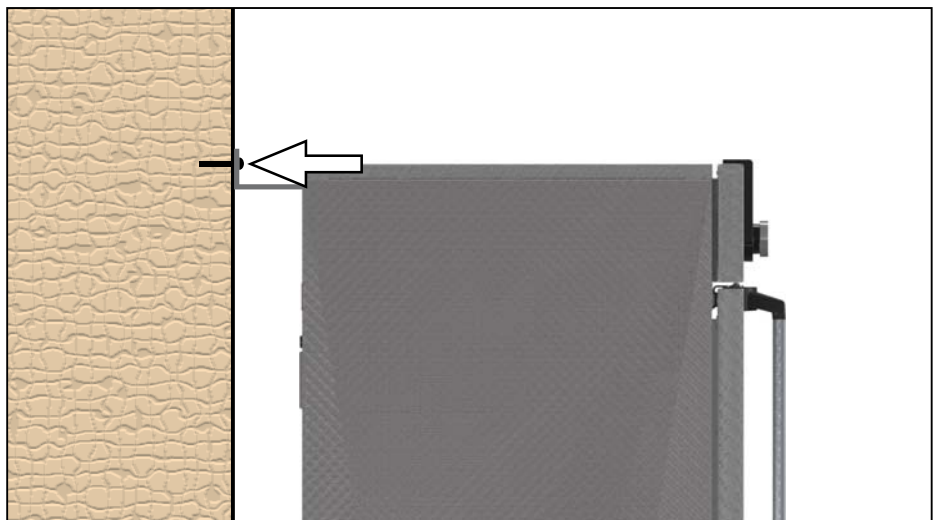
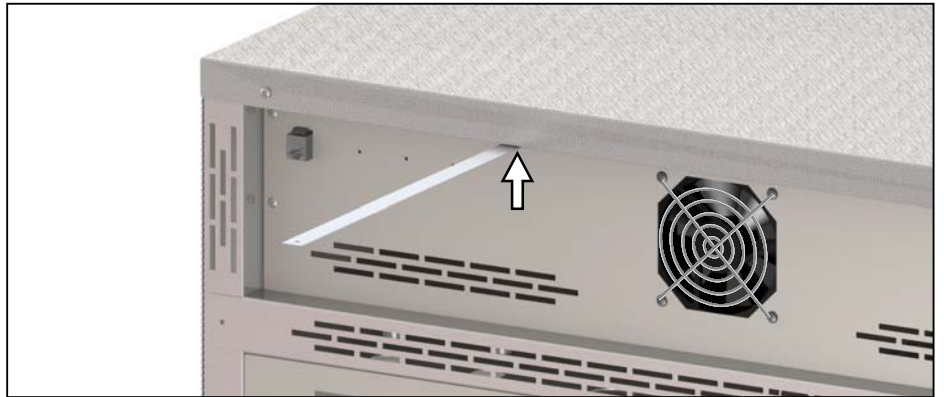

### 3.6.4 Adjusting the doors (only for model size 750)

For model size 750, it is possible to adjust doors that warp due to the floor conditions. In order to do so, every door has two adjuster screws at the top and at the bottom (Fig. 8).

**i** First, adjust the door at the top and then, if further adjustment is necessary, at the bottom as well.

1. Open the door.
2. Undo the screws.
3. Adjust the door.
4. Tighten the screws again.
5. Check door alignment.
6. If necessary, readjust.

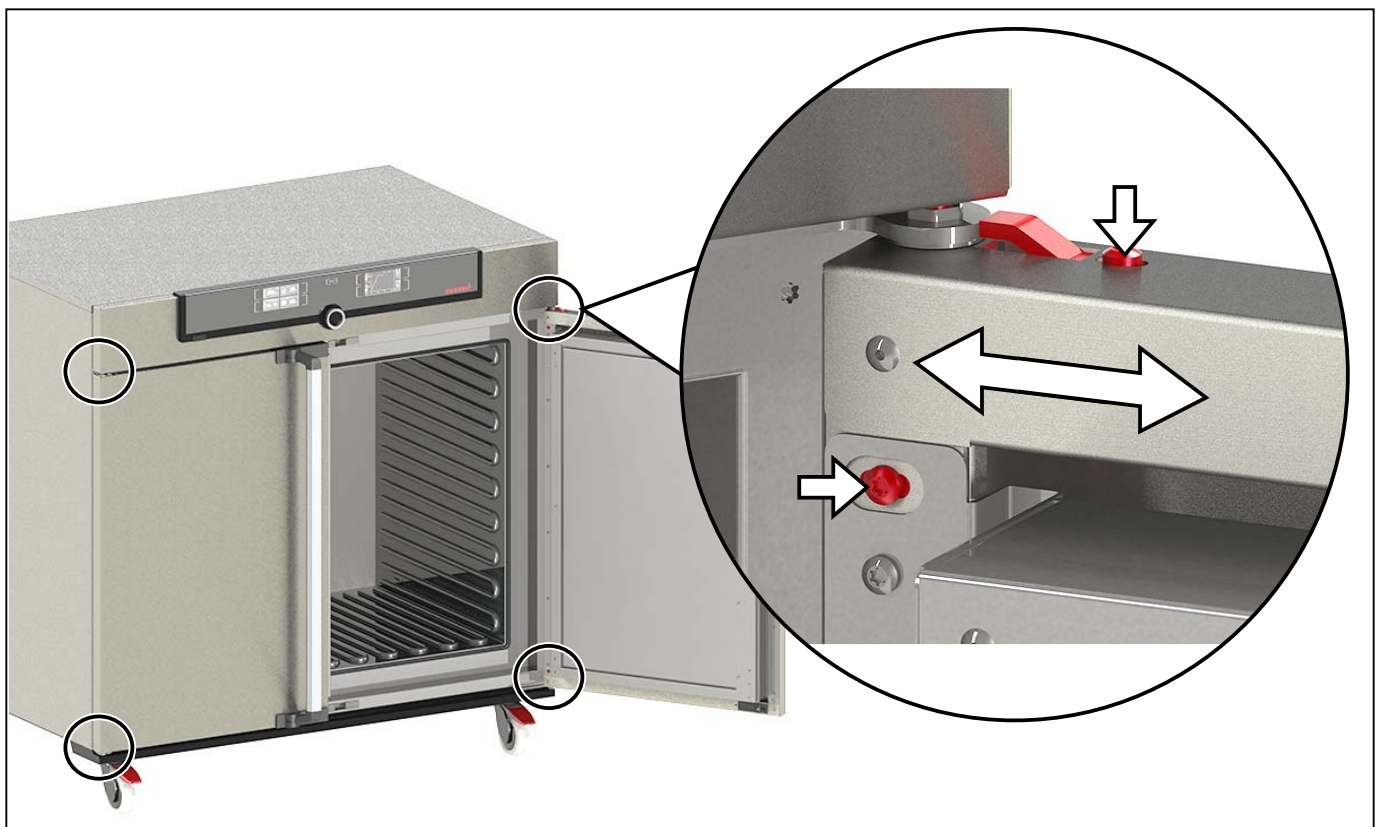

Fig. 8 Door adjustment screws

## 4. Putting into operation

### ● Caution:

**i** The first time the appliance is operated, it must not be left unattended until it has reached the steady state.

### 4.1 Connecting the appliance

#### ● Caution:

**i** Observe the country-specific regulations when making connections (e.g. in Germany DIN VDE 0100 with residual current circuit breaker). Observe the connection and power ratings (see nameplate and "Technical Data" on page 13). Make sure to establish a safe PE conductor connection.

Plug the provided power cable into the rear of the appliance and connect it to the power supply (Fig. 9).

Lay the power cable so that

- ▶ it is always accessible and within reach so it can be disconnected quickly in the event of failure or emergencies;
- ▶ no one can trip over it;
- ▶ it does not come into contact with any hot parts.

### 4.2 Switching on

Switch on the appliance by pressing the main switch on the front of the appliance (Fig. 10).

The starting process is shown by three animated white dots **●●●**. If the dots have another colour, an error has occurred (see page 30).

**i** After the first start-up, the appliance display is set to English by default. You can change the language as described from page 32. However, to get a basic overview of operating the appliance, you should read the following chapter first.

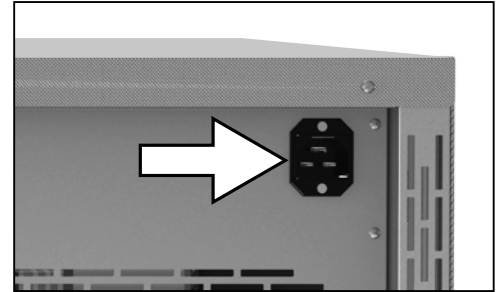

Fig. 9 Connect the power cable to the rear of the appliance

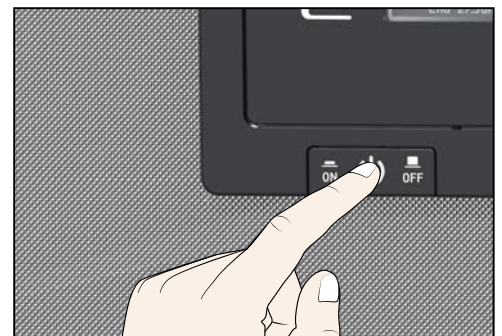

Fig. 10 Switch on appliance



## 5. Operation and control

### 5.1 Operating personnel

The appliance may only be operated by persons who are of legal age and have been instructed accordingly. Personnel who are to be trained, instructed or who are undergoing general training may only work with the appliance under the continuous supervision of an experienced person.

### 5.2 Opening the door

- ▶ To open the door, pull the door handle to the side (to the left or to the right, depending on the door variation, see Fig. 11, A) and open the door completely.
- ▶ To close the appliance, push the door closed and the door handle to the side (B).

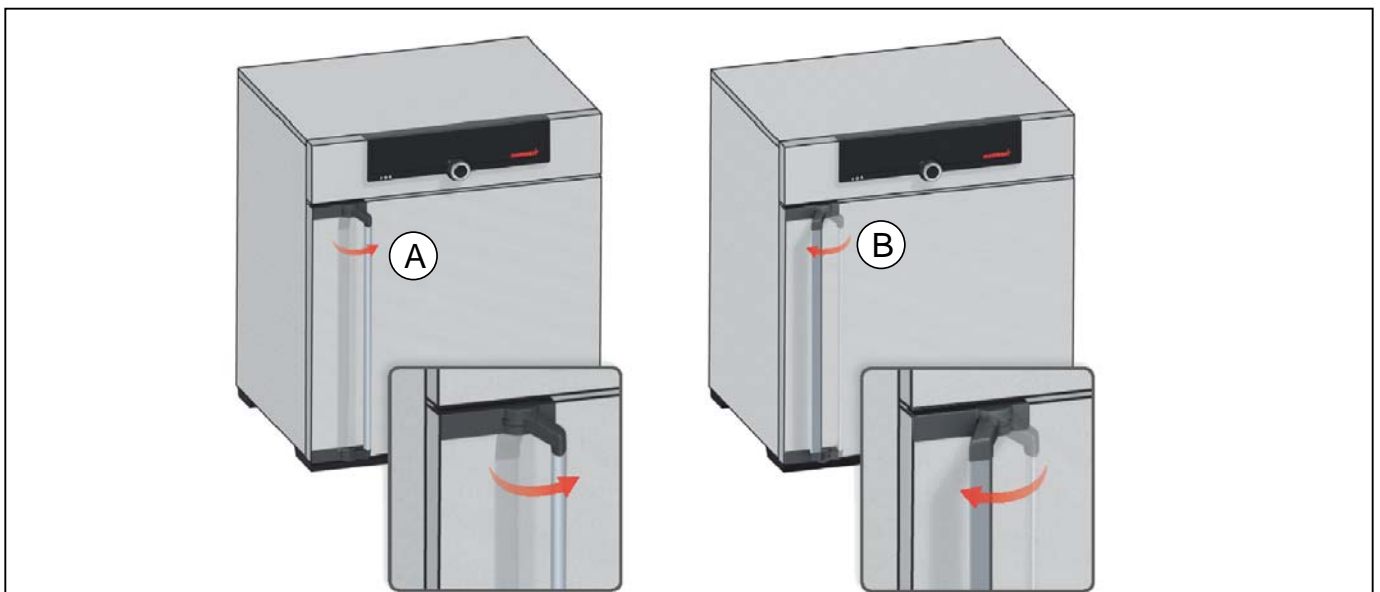

Fig. 11 Opening and closing the door



#### Warning!

If the door is open while the appliance is in operation, the appliance may overheat and pose a fire hazard. Do not leave the door open during operation.



#### Warning!

In case of appliances of a certain size, you can get accidentally locked in, which is life-threatening. Do not climb into the appliance!

## 5.3 Loading the appliance



### Warning!

When loading the appliance with an unsuitable load, poisonous or explosive vapours or gases may be produced. This could cause the appliance to explode, and people could be severely injured or poisoned. The appliance may only be loaded with materials which do not form any toxic or explosive vapours when heated up and cannot ignite (see also Intended use on page 8). If there is any doubt as to the composition of materials, they must not be loaded into the appliance.



### i Caution:

Check the chamber load for chemical compatibility with the materials of the appliance (see page 11).

Insert the sliding steel grids or sliding shelves. The maximum number of grids / shelves and the load capacity are specified in the technical data overview from page 13.

The chamber must not be loaded too tightly, so that proper air circulation in the interior is guaranteed. Do not place any of the chamber load on the floor, touching the side walls or right below the ceiling of the chamber (Fig. 12, see also the "correct loading" sticker on the appliance).

In case of improper loading (chamber loaded too tightly), the set temperature may be exceeded or it may take longer until it is reached.

i To achieve the correct heating capacity, the type of slide-in unit used – Grid or Shelf – must be set in the menu under **SETUP** (see page 35).

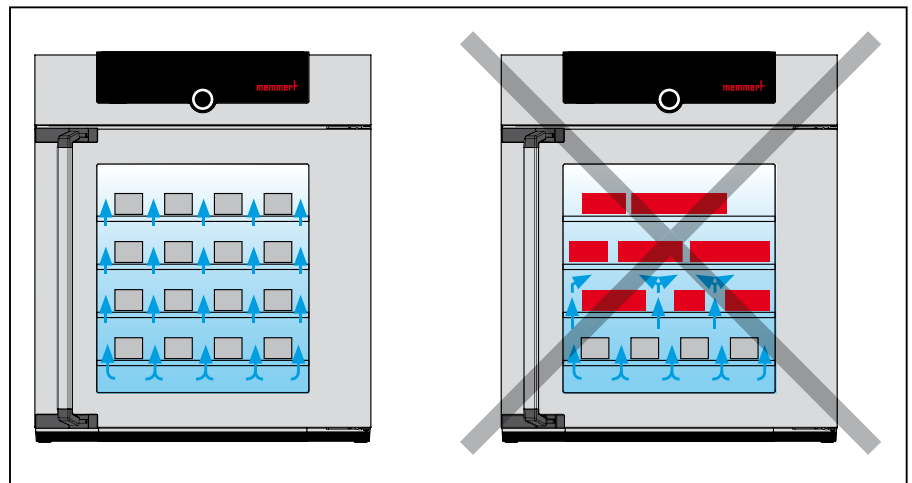

Fig. 12 Correct placement of the chamber load



## 5.4 Operating the appliance

### 5.4.1 ControlCOCKPIT

In manual operation, the desired parameters are entered at the ControlCOCKPIT on the front of the appliance (Fig. 13 and Fig. 14). You can also make basic settings here (menu mode). Additionally, warning messages are displayed, e.g. if the temperature is exceeded.

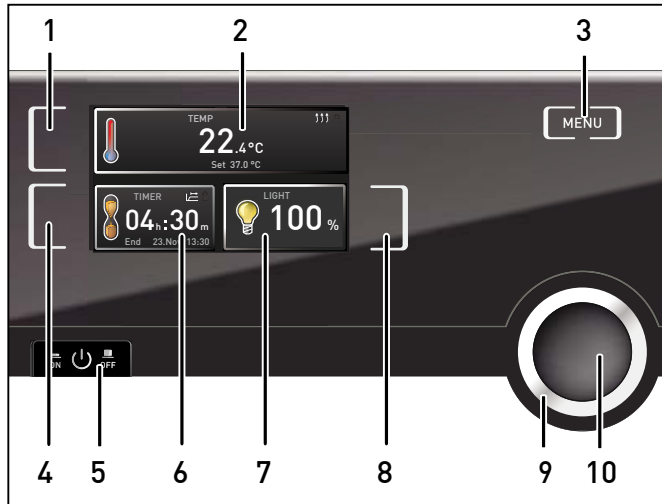

Fig. 13 ControlCOCKPIT of Peltier-cooled incubators IPP in operating mode

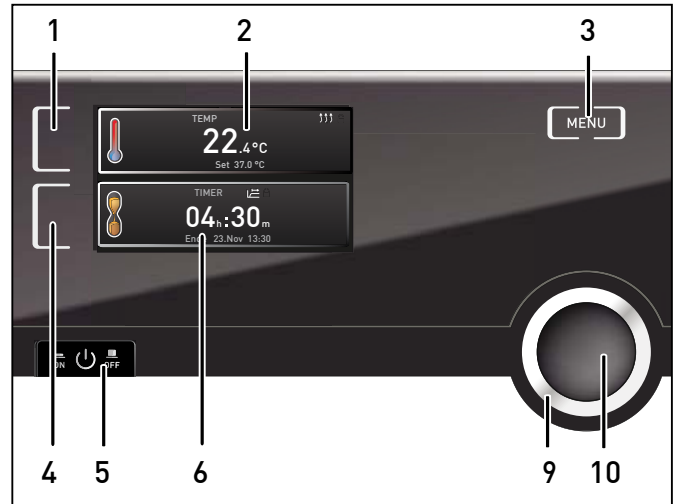

Fig. 14 ControlCOCKPIT of cooled storage incubators IPS in operating mode

- 1 Activation key for temperature setpoint adjustment
- 2 Setpoint and actual temperature display
- 3 Switch to menu mode (see page 31)
- 4 Activation key digital backwards counter with target time setting, adjustable from 1 minute to 99 days
- 5 Main switch
- 6 Display digital backwards counter with target time setting, adjustable from 1 minute to 99 days
- 7 Interior lighting display (only for models with light module)
- 8 Interior lighting activation key (only for models with light module)
- 9 Turn control for individual setpoint adjustment
- 10 Confirmation key (accepts setting made with the turn control)

### 5.4.2 Basic operation

In general, all settings are made according to the following pattern:

1. Activate the desired parameter (e.g. temperature). To do so, press the corresponding activation key on the left or right of the respective display. The activated display is lined in colour, the other displays are dimmed. The set value is highlighted in colour.
2. By turning the turn control to the left or right, adjust the set value (e.g. to 37.0 °C).

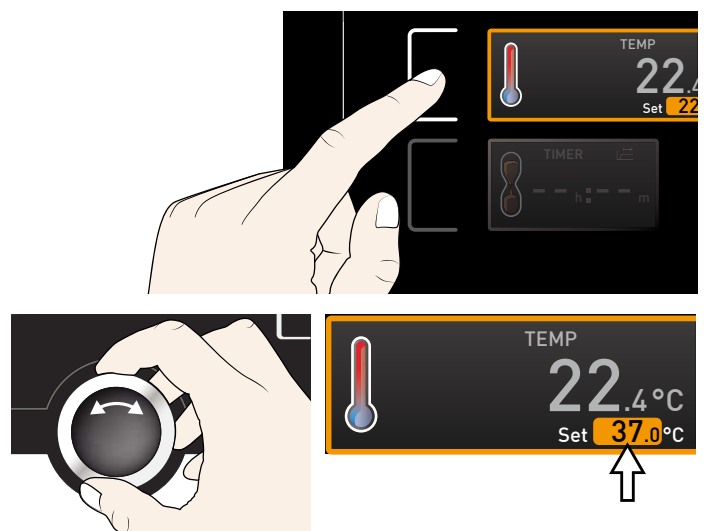

- Save the set value by pressing the confirmation key.  
The display returns to normal and the appliance begins adjusting to the defined set value.

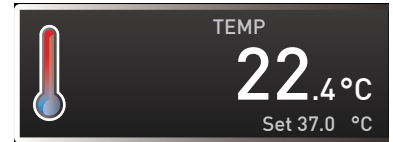
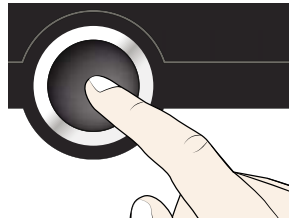

Additional parameters can be set accordingly.

- If no new values are entered or confirmed for approx. 30 seconds, the appliance automatically restores the former values.

If you want to cancel the setting procedure, press the activation key on the left or right of the display that you want to exit. The appliance restores the former values. Only the settings that you have confirmed by pressing the confirmation key before cancelling the setting procedure are accepted.

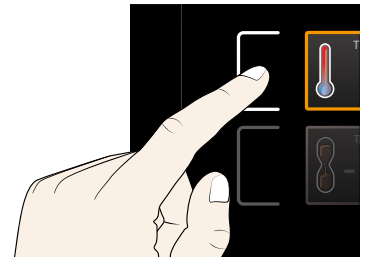

### 5.4.3 Adjustment options

As described in chapter 5.4.2, you can set the following parameters after pressing the corresponding activation key (in any sequence):

#### Temperature

Adjustment range: model-dependent (see nameplate and technical data on page 13)

- Heating operation is indicated by the  $\uparrow\uparrow\uparrow$  symbol.
- Cooling is indicated by the  $\ast$  symbol.

You can select °C or °F as the temperature unit displayed (see page 35).

The minimum temperature that can be reached depends on the surrounding conditions. The IPP appliances reach up to to 20 °C below room temperature. In order to do so, the Peltier module needs sufficient ventilation (see Fig. 7 on page 18).

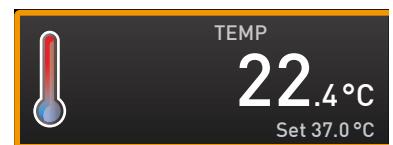

#### Interior lighting (only for cooled incubators IPP with light module)

Adjustment range: 0 % (off), 100 % (on)



### 5.4.4 Operation with digital backwards counter with target time setting, adjustable from 1 minute to 99 days (Timer)

In timer operation, you can adjust the time the appliance runs at the set temperature.

- Press the activation key to the left of the timer display. The timer display is activated.

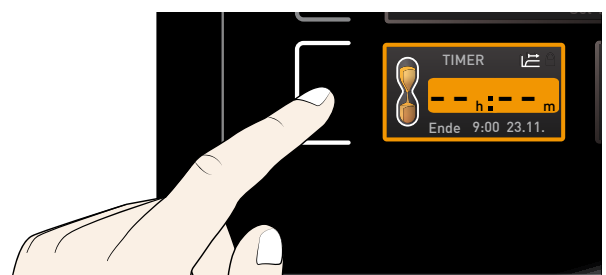

- Turn the turn control until the desired duration is displayed – in this example 4 hours 30 minutes. The approximate end time is shown beneath, in a smaller font.

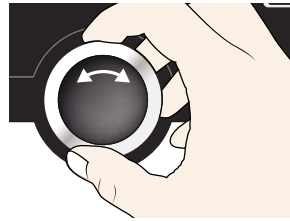

- i** Up to a duration of 23 hours 59 minutes, the time is displayed in hh:mm (hours:minutes) format. For 24 hours and more, the format dd:hh (days:hours) is used. The maximum duration adjustable is 99 days 00 hours.

- Press the confirmation key to confirm.

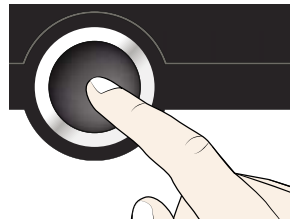

The display now shows the remaining time in a large font and the approximate end time in a smaller font beneath.



- Now, as described under 5.4.2, set the temperature you want the appliance to operate at. The set value can be changed at any time while the timer elapses. The changes are effective immediately.

- i** In **Setup**, you can choose if the timer should run setpoint-dependent or not. This determines whether the timer should not start until a tolerance band around the set temperature is reached or if it should start right after activation (see page 35). If the timer runs setpoint-dependent, this is indicated by the  symbol in the timer display.

When the timer has elapsed, the display shows 00h:00m. Heating or cooling is switched off. In addition, an acoustic alarm sounds, which can be turned off by pressing the confirmation key.

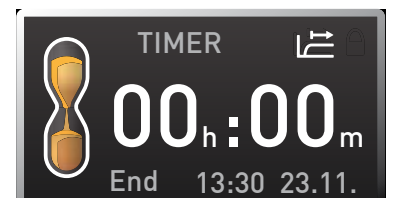

To deactivate the timer, open the timer display by pressing the activation key again and then turning the turn control to reduce the timer setting until --:-- is displayed. Confirm with the confirmation key.

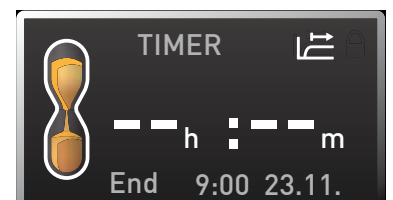

## 5.5 Temperature monitoring

The monitoring temperature of the electronic temperature monitoring is measured via a separate Pt100 temperature sensor in the interior. The monitoring temperature is set in menu mode in the Setup display (see page 35). The setting made applies to all operating modes.

If the manually set monitoring temperature is exceeded, the temperature monitoring takes over temperature control and begins to regulate to the monitoring temperature (Fig. 15).

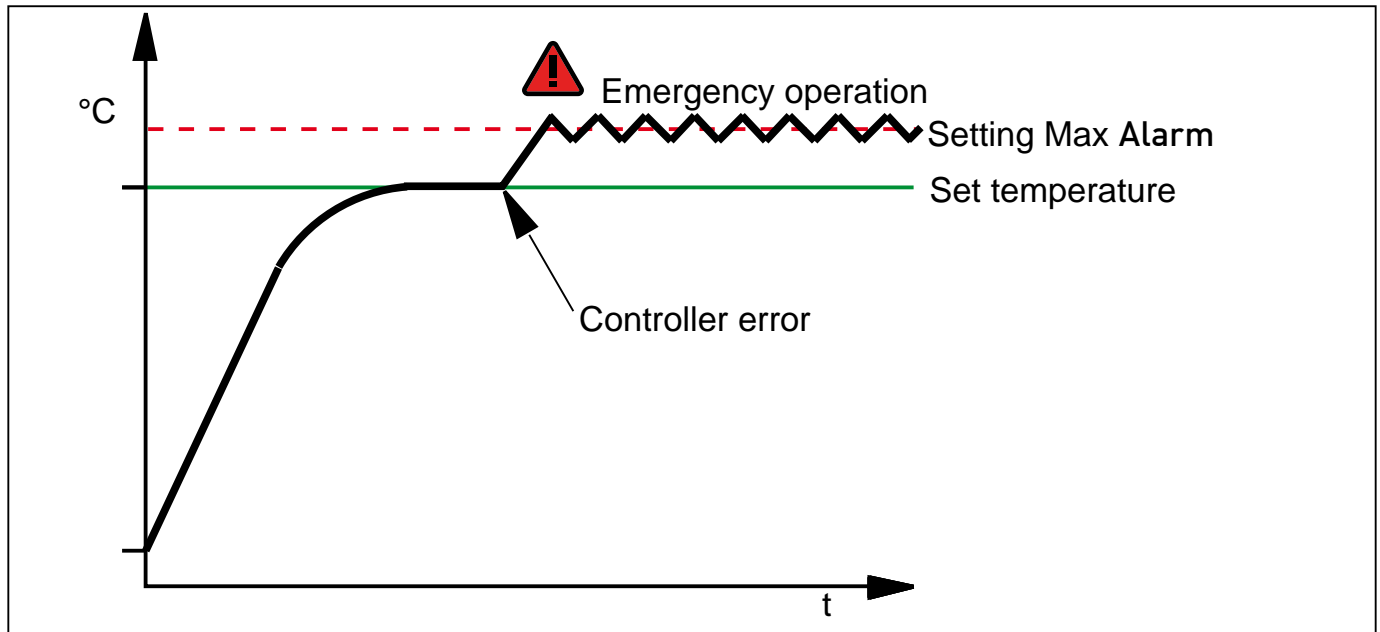



Fig. 15 Schematic diagram of how the TWW temperature monitoring system works

### 5.5.1 Function

If temperature monitoring has been triggered, this is indicated by the temperature display: the actual temperature is highlighted in red and a warning symbol  is shown (Fig. 16). Below, the display shows that the TWW temperature monitoring has triggered. The alarm is additionally signalled by an intermittent acoustic signal, which can be turned off by pressing the confirmation key. Information on what to do in this case are provided in the chapter Malfunctions, warning and error messages from page 29.

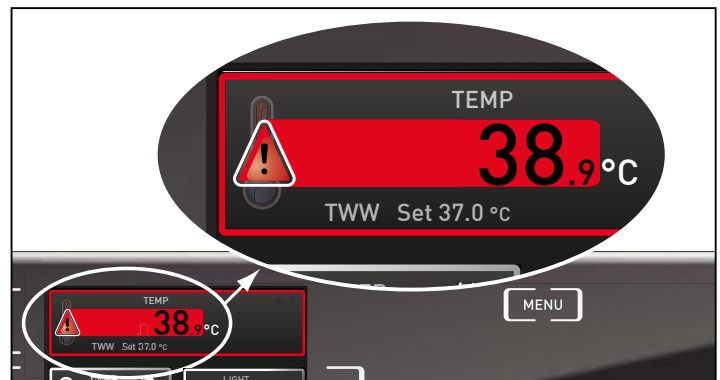

Fig. 16 Temperature monitoring triggered

## 5.6 Ending operation

1. Switch off active appliance functions (turn back the set values).
2. Remove the chamber load.
3. Switch off the appliance with the main switch (Fig. 17).

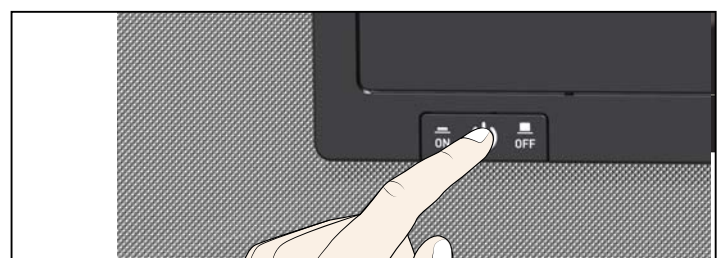







Fig. 17 Switch off appliance



Error description	Cause of errors	Rectifying errors	See
<p>Error message E-3 in the temperature display</p> 	<p>Temperature sensor defective.</p>	<ul style="list-style-type: none"> <li>▶ Switch off appliance.</li> <li>▶ Remove the chamber load</li> <li>▶ Contact customer service</li> </ul>	<p>page 2</p>
<p>When switching on the appliance, the start animation is displayed in another colour than white </p>	<ul style="list-style-type: none"> <li>▶ Cyan : Not enough storage space on the SD card</li> <li>▶ Red : The system files could not be loaded</li> <li>▶ Orange : The fonts and images could not be loaded</li> </ul>	<p>Contact customer service</p> <p>Contact customer service</p> <p>Download the firmware update at <a href="http://memmert.com">memmert.com</a> and install it</p>	<p>page 2</p> <p>page 2</p>

### 6.3 Power failure

In case of a power failure, the appliance operates as follows:

In normal operation

After power supply has been restored, operation is continued with the parameters set. The time and duration of the power failure are documented in the log memory.

In timer mode

In case of an interruption of the power supply of less than 60 minutes, the current timer is continued from the point at which it was interrupted. For longer interruptions of the power supply, all appliance functions are switched off.

In remote control mode:

The previous values are restored.

## 7. Menu mode

In menu mode, you can make basic settings as well as adjust appliance parameters.

### **i Caution:**

Before changing menu settings, read the description of the respective functions on the following pages to avoid possible damage to the appliance and/or chamber load.

To enter menu mode, press the MENU key.

To exit the menu mode at any time, press the MENU key again. The appliance then returns to operating mode. Only changes accepted by pressing the confirmation key are saved.

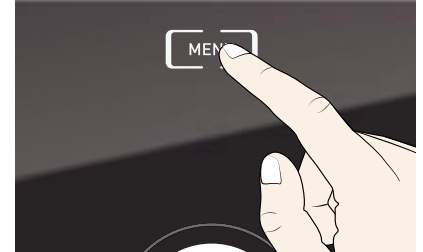

### 7.1 Overview

Press the MENU key to change between the displays in menu mode:

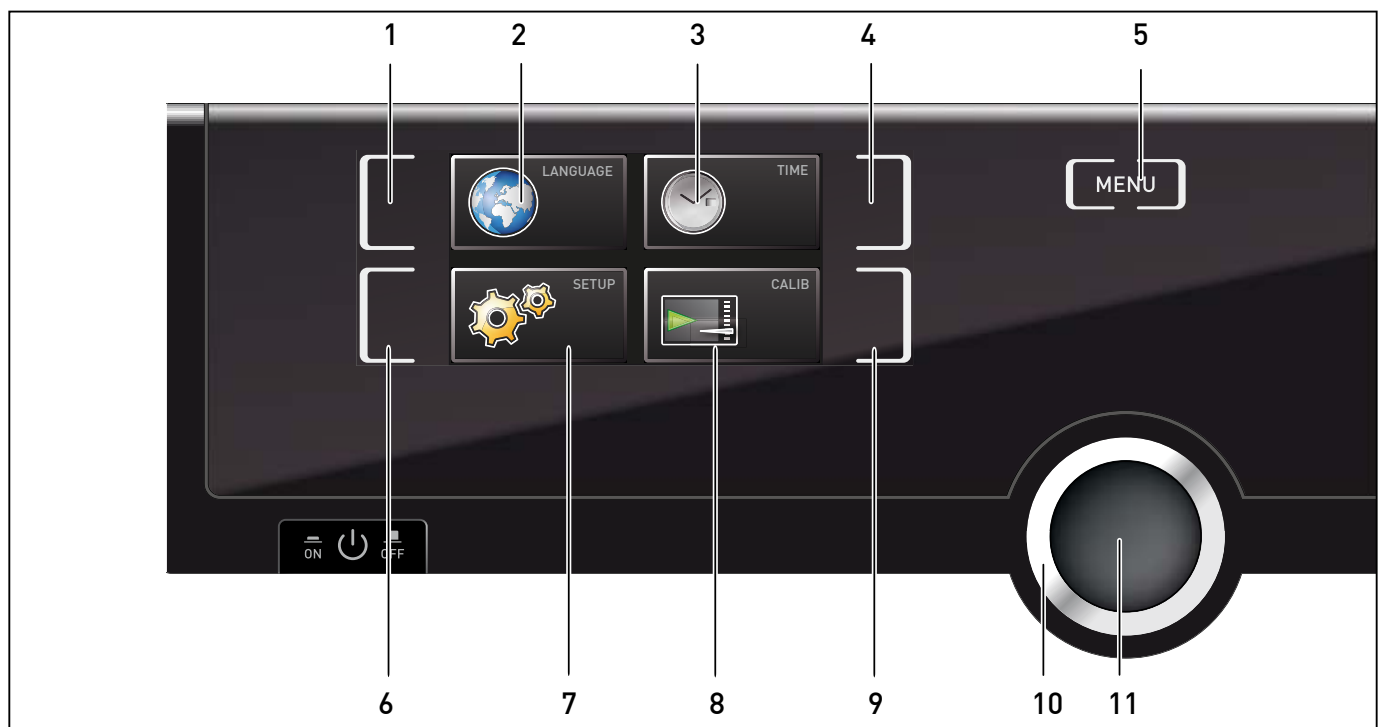

Fig. 18 ControlCOCKPIT in menu mode

- |   |  |
|---|--|
| 1 Language selection activation key               | 7 Setup display (basic appliance settings)                       |
| 2 Language selection display                      | 8 Adjustment display   |
| 3 Date and time display                           | 9 Adjustment activation key                                      |
| 4 Date and time setting activation key            | 10 Turn control for adjustment                                   |
| 5 Exit menu mode and return to operating mode     | 11 Confirmation key (accepts setting made with the turn control) |
| 6 Setup activation key (basic appliance settings) |  |



## 7.2 Basic operation in menu mode using the example of language selection

In general, all settings in menu mode are done just like in operating mode: Activate the respective display, use the turn control for setting and press the confirmation key to accept the change. A more detailed description is provided in the following, using the example of language selection.

1. Activate the desired parameter (in this example the language). To do so, press the corresponding activation key on the left or right of the respective display. The activated display is enlarged.

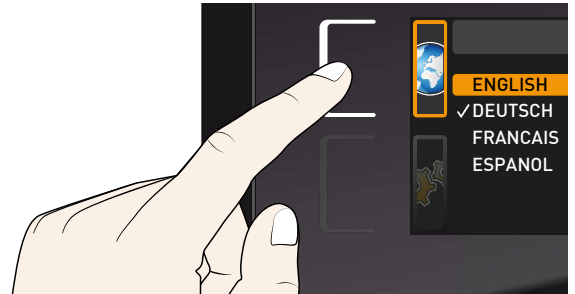

**i** If you want to interrupt or cancel your settings, again press the activation key which you have used to activate the display. The appliance returns to the menu overview. Only the settings that you have confirmed by pressing the confirmation key before cancelling the setting procedure are accepted.

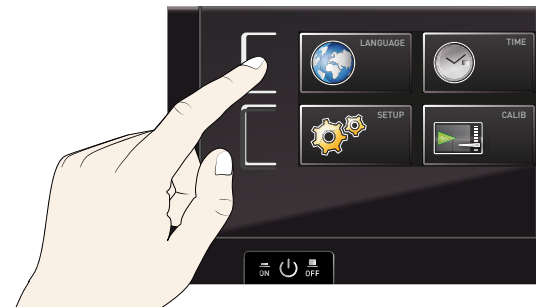

2. With the turn control, select the desired new setting, e.g. Spanish (Español).

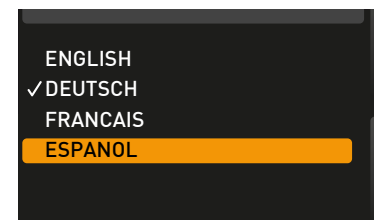
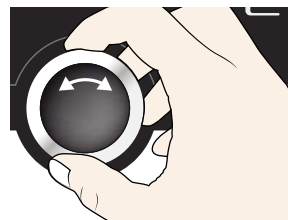

3. Save the setting by pressing the confirmation key.

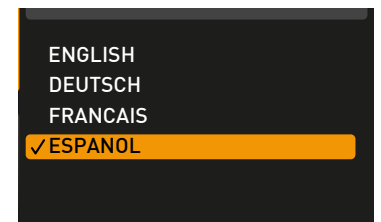
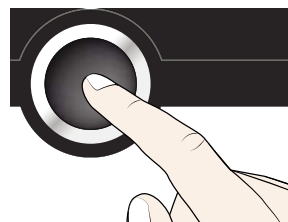

4. To return to the menu overview, press the activation key again.

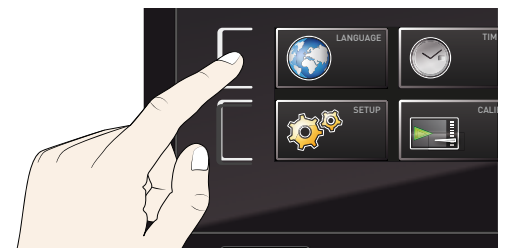

You can now

- ▶ activate another menu function by pressing the corresponding activation key or
- ▶ return to operating mode by pressing the MENU key.

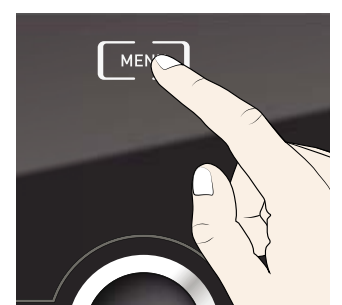



All other settings can be made accordingly. The settings possible are described in the following sections.

**i** If no new values are entered or confirmed for approx. 30 seconds, the appliance automatically restores the former values.

### 7.3 Setup

In the **SETUP** display, you can set the following parameters:

- ▶ the **IP address** and **Subnetmask** of the appliance's Ethernet interface (for connection to a network)
- ▶ the **Unit** of the temperature display (°C or °F, see page 35)
- ▶ how the digital backwards counter with target time setting works (**Timer mode**, see page 35)
- ▶ the type of the slide-in unit (Grid or Shelf, see page 35)
- ▶ the trigger temperature of the monitoring function (**Max alarm**, see page 35)
- ▶ Remote control (see page 36)
- ▶ Gateway (see page 36)

**i** If the **SETUP** menu contains more entries than can be displayed, this is indicated by the display "1/2". This means that there is a second „page“ of entries.

To display the hidden entries, use the turn control to scroll beyond the lowest entry. The page display changes to "2/2".

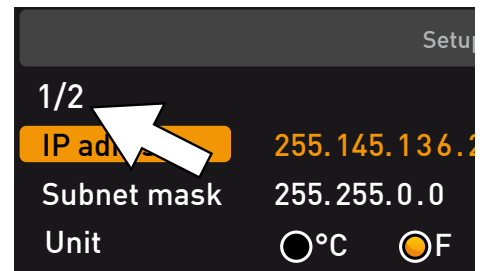

#### 7.3.1 IP address

If you want to operate one or more appliances in a network, each appliance must have its own unique IP address for identification. By default, each appliance is delivered with the IP address 192.168.100.100.

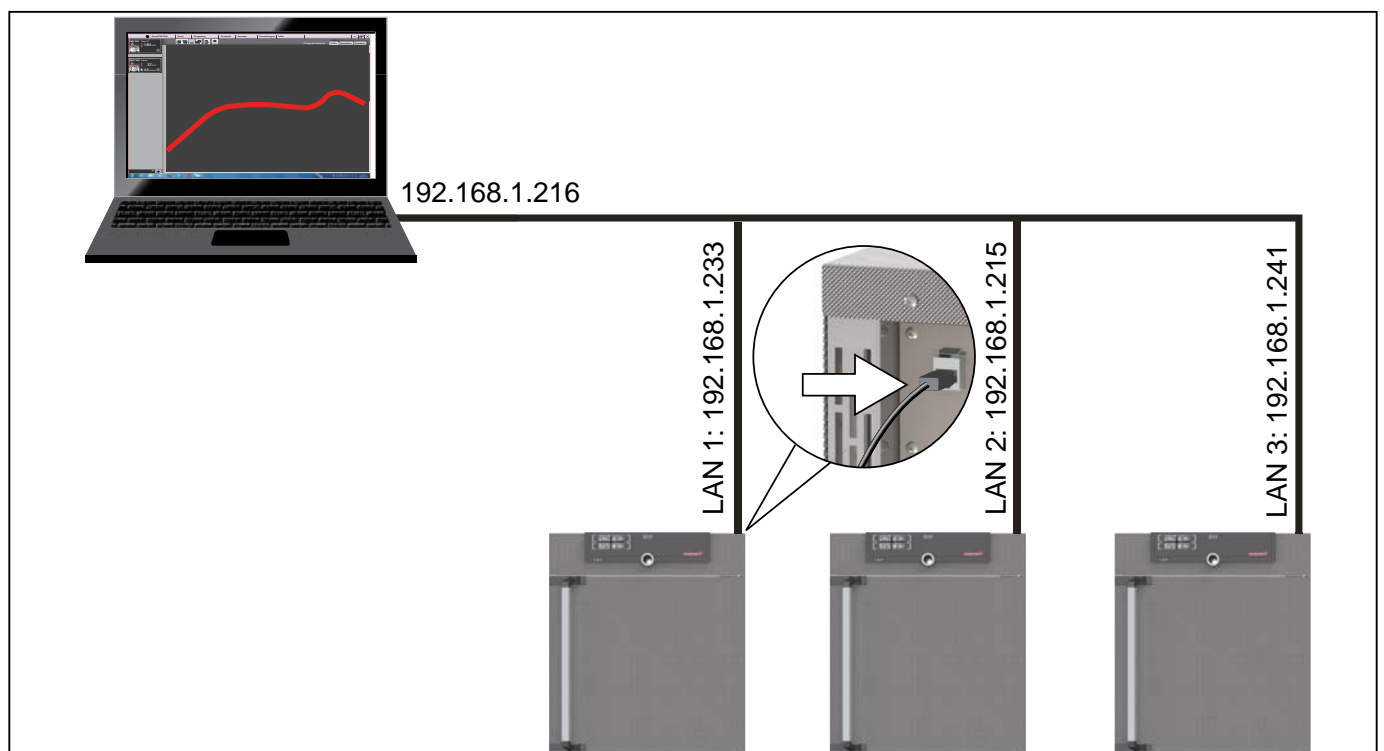
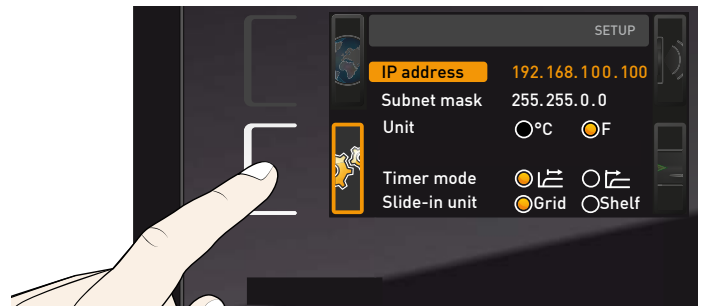
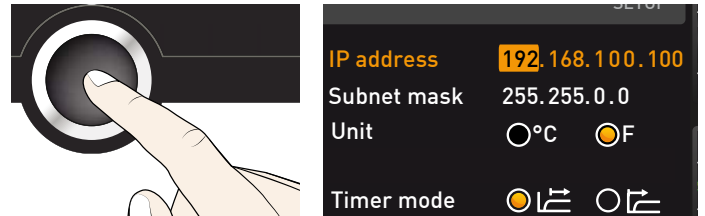

Fig. 19 Operation of several appliances in a network (schematic example)

1. Activate the **SETUP** display. The entry **IP address** is automatically highlighted.



2. Accept the selection by pressing the confirmation key. The first three digits of the IP address are automatically selected.



3. With the turn control, set the new number, e.g. 255.

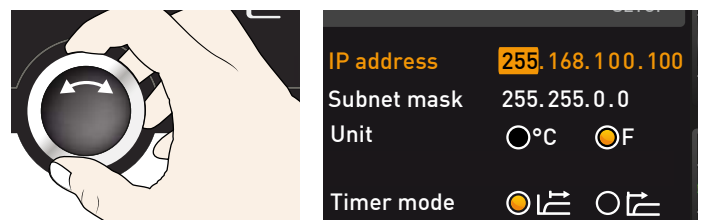

4. Accept the selection by pressing the confirmation key. The next three digits of the IP address are automatically selected. Setting these is done with the turn control according to the description above.



5. After setting the last three digits, accept the new IP address by pressing the confirmation key. The selection returns to the overview.

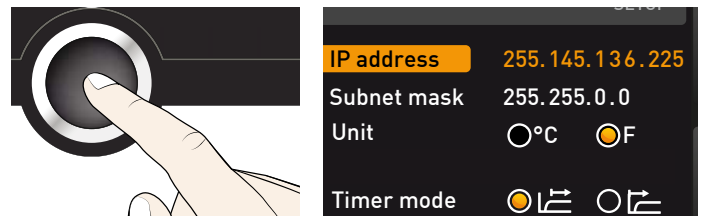

The subnet mask is set accordingly.

### 7.3.2 Unit

Here, you can choose whether the temperature is displayed in °C or °F.

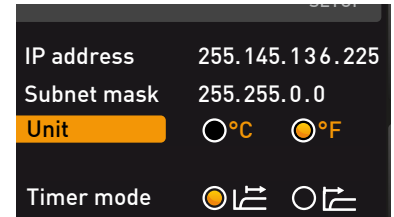

### 7.3.3 Timer mode

Here, you can choose whether the digital backwards counter with target time setting (see page 26) should run setpoint-dependent or not. This determines whether the timer should not start until a tolerance band of ±3 K around the set temperature is reached (Fig. 20, B) or if it should start right after activation (A).

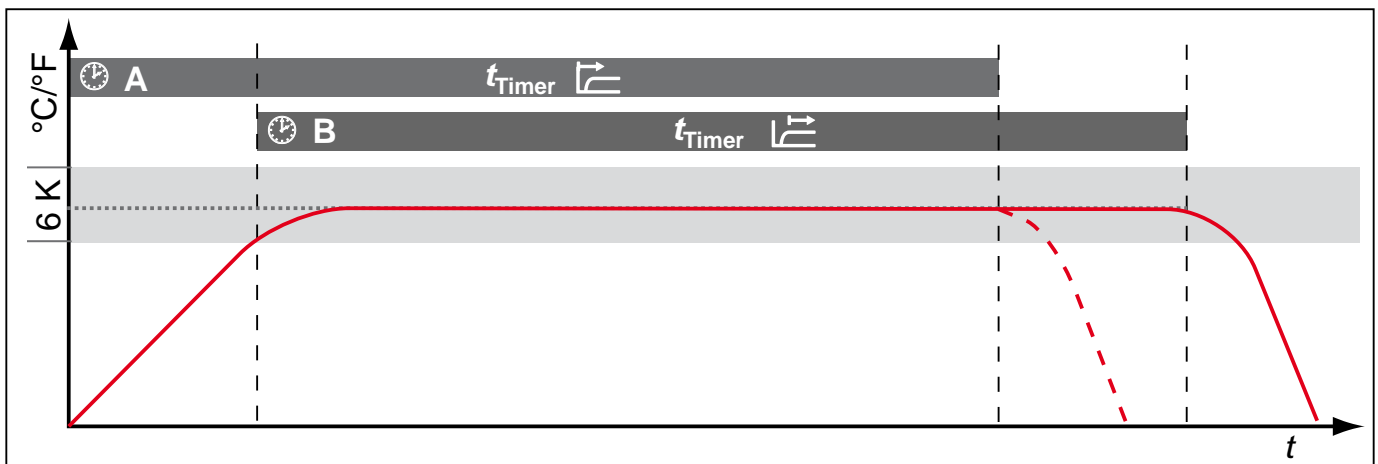
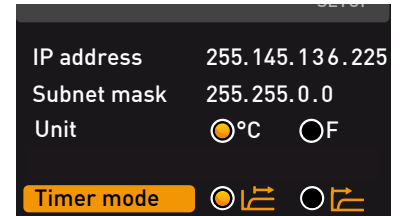

Fig. 20 Timer mode

A Timer independent of setpoint: Timer starts right after activation

B Timer setpoint-dependent: Timer does not start until tolerance band is reached

### 7.3.4 Type of the slide-in unit (Grid or Shelf)

Here, you have to set the type of the slide-in unit (grid or shelf) used. The selection Shelf enables you to adjust the control function to the different air flow characteristics in the interior when using optional sliding shelves instead of the grids that are part of the standard delivery.

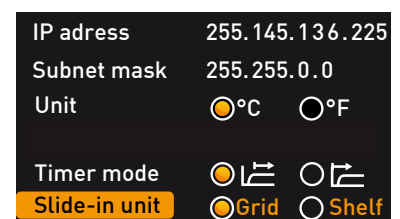

### 7.3.5 Temperature monitoring

Here, you can set the trigger temperature of the automatic temperature monitoring system (Max Alarm, description from page 28).

**i** The monitoring temperature must be set sufficiently high above the maximum set temperature. We recommend 1 to 3 K.

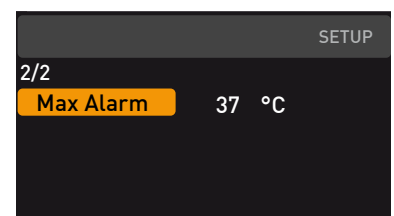



## Menu mode

### 7.3.6 Remote control

In the setup entry **Remote control**, you can set whether the appliance should be controlled via remote control and if so, in which mode. These settings are available:

- ▶ Off
- ▶ Read Only
- ▶ Write
- ▶ Write+Alarm

When the appliance is in remote control mode, the  symbol appears in the temperature display. In the settings **Write** and **Write+Alarm**, the appliance cannot be controlled at the ControlCOCKPIT until the remote control has been switched off (setting Off) or set to **Read Only**.

 In order to use the remote control function, programming skills and special libraries are required.

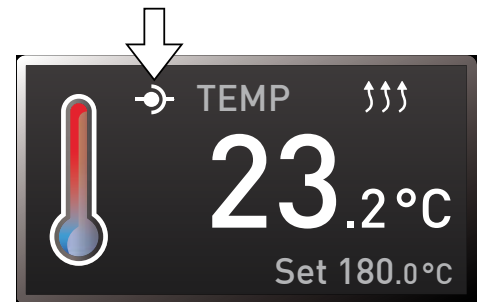
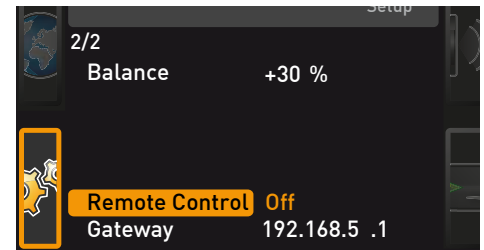

### 7.3.7 Gateway

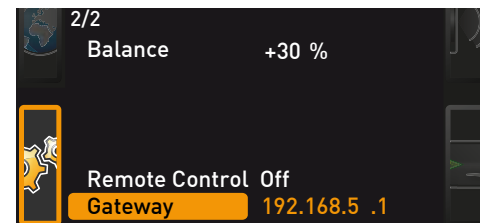

The setup entry **Gateway** is used to connect two networks with different protocols.

The gateway is set the same way as the IP address (see page 33).



## 7.4 Date and Time

In the **Time** display, you can set date and time, time zone and daylight saving time.

-  Always set the time zone (and summer time yes/no) before you set the date and time.
-  Avoid changing the set time after that since this can lead to gaps or overlapping when recording measured values. If you still need to change the time, you should not run a programme immediately before or after doing so.

1. Activate the time setting. To do so, press the activation key on the right side of the **Time** display. The display is enlarged and the first adjustment option (**Date**) automatically highlighted.



2. Turn the turn control until **Time zone** is highlighted.

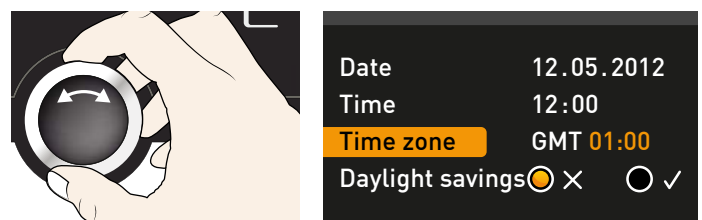

3. Accept the selection by pressing the confirmation key.

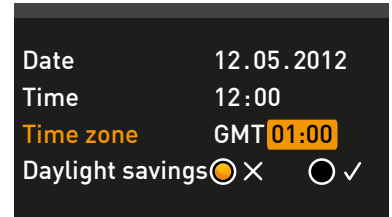
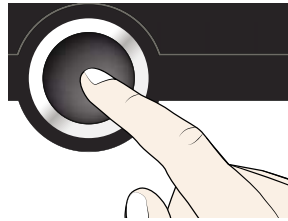

4. Set the time zone of the installation site with the turn control, e.g. 00:00 for France, Spain or Great Britain, 01:00 for Germany. Accept the selection by pressing the confirmation key.

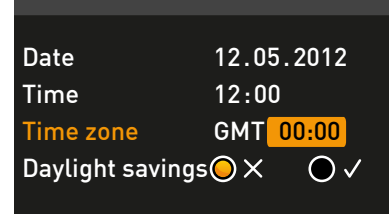

5. With the turn control, select the Daylight savings entry

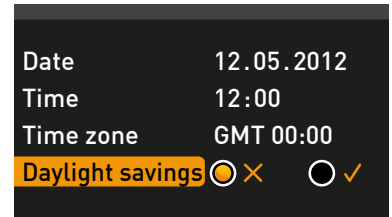
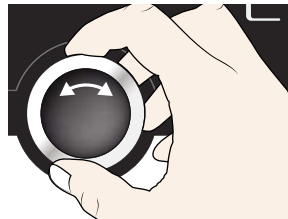

6. Accept the selection by pressing the confirmation key. The adjustment options are highlighted.

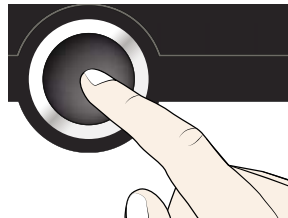

7. Set daylight savings to off (X) or on (✓) with the turn control – in this case on (✓). Save the setting by pressing the confirmation key.

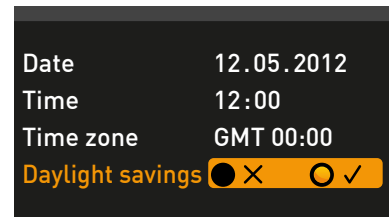
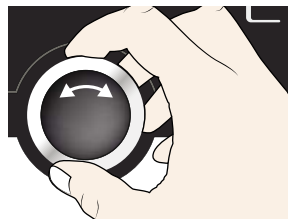

**i** Daylight saving time and standard time are not changed automatically. For this reason, please keep in mind to adjust them at the beginning of each period.

8. Now, set date (day, month year) and time (hours, minutes) in the same way. Accept the selection by pressing the confirmation key.

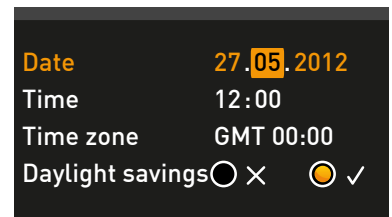
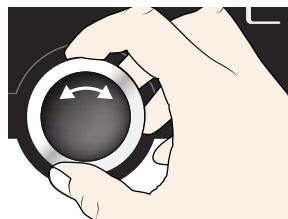

## 7.5 Calibration

The appliances are temperature calibrated and adjusted at the factory. In case readjustment should be necessary later on – for example due to influence of the chamber load – the appliance can be calibrated customer-specifically using three calibration temperatures of your choice:

- ▶ Cal1 Temperature calibration at low temperature
- ▶ Cal2 Temperature calibration at medium temperature
- ▶ Cal3 Temperature calibration at high temperature

To guarantee perfect control, we recommend to calibrate the appliance once a year.

**i** For temperature adjustment, you will need a calibrated reference measuring device.

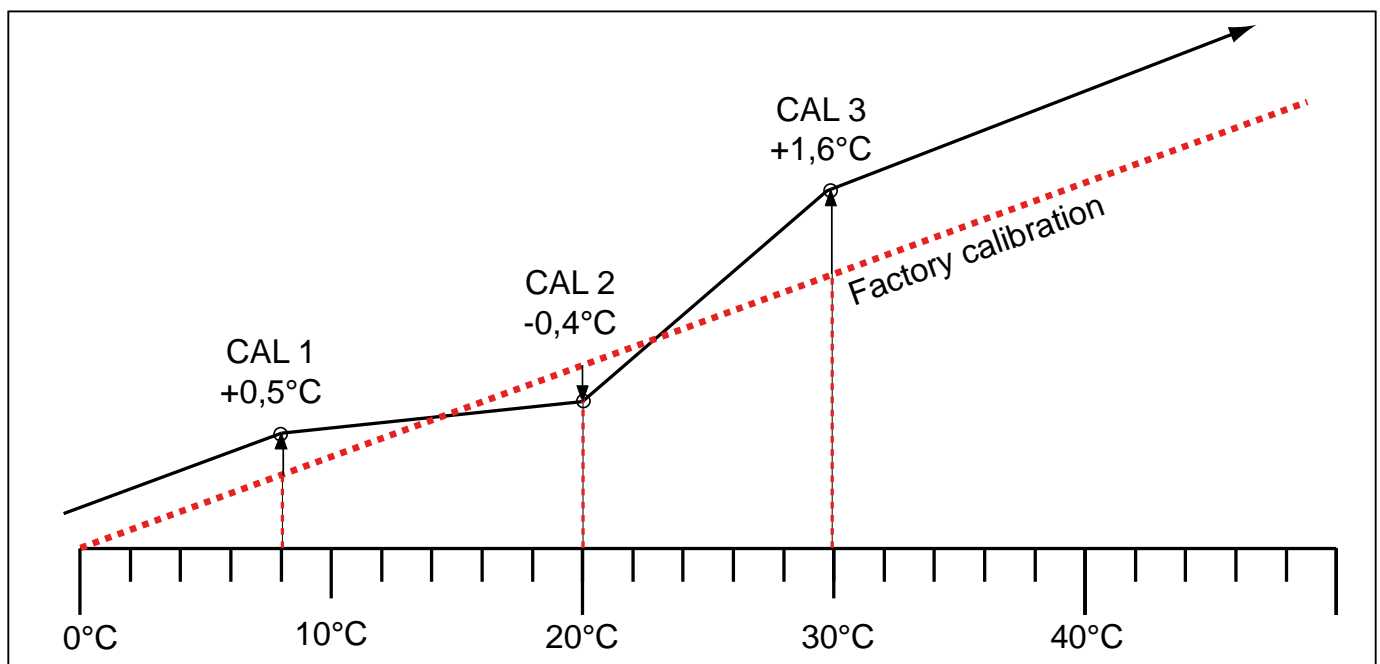
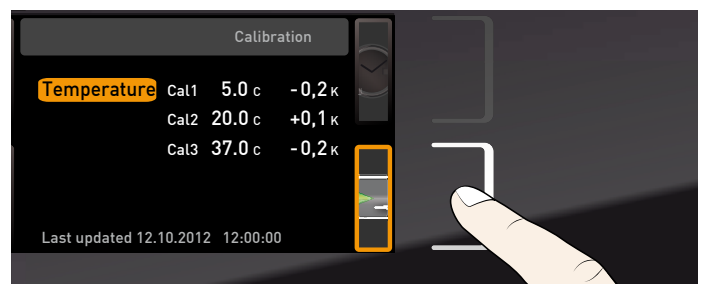

Fig. 21 Schematic example of temperature adjustment

Example: Temperature deviation at 30 °C should be corrected.

1. Press the activation key to the right of the **CALIB** display. The display is enlarged and the temperature adjustment option is automatically highlighted.



2. Press the confirmation key repeatedly, until the calibration temperature Cal2 is selected.

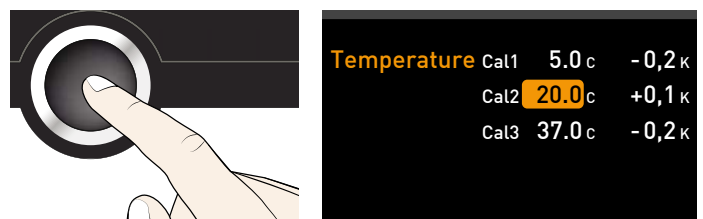

3. With the turn control, set the calibration temperature Cal2 to 30 °C.

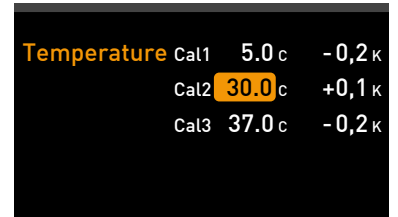
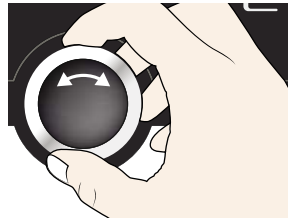

4. Save the setting by pressing the confirmation key. The corresponding calibration value is automatically highlighted.

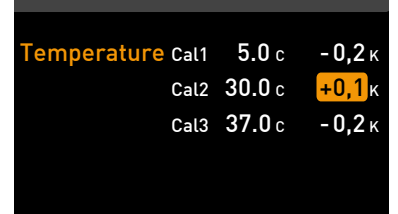
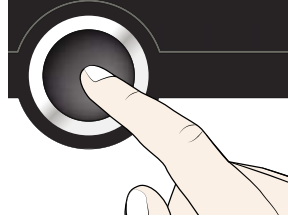

5. Set the calibration value to 0.0 K and accept the setting by pressing the confirmation key.

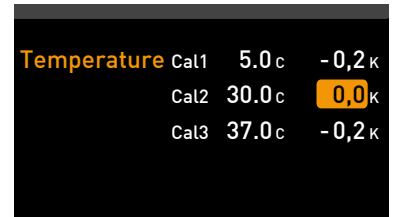
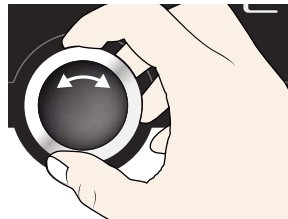

6. Position the sensor of a calibrated reference instrument centrally in the appliance's working chamber.

7. Close the door and, in manual mode, adjust the set temperature to 30 °C.

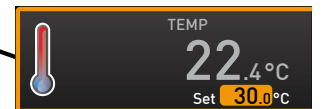
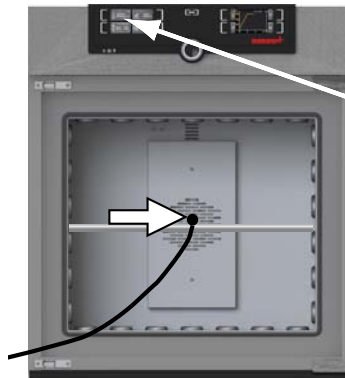

8. Wait until the appliance reaches the set temperature and displays 30 °C. The reference instrument for example displays 31.6 °C.

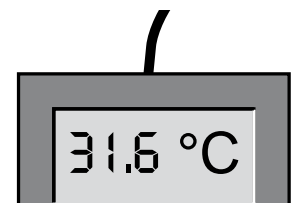
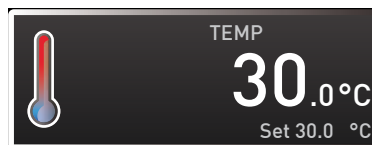

9. In the SETUP, adjust the calibration value Cal2 to +1.6 K (actual value measured minus setpoint temperature) and save the setting by pressing the confirmation key.

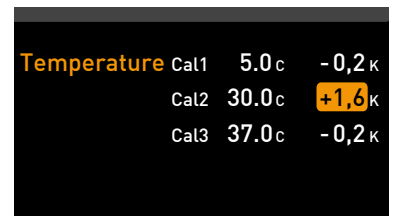
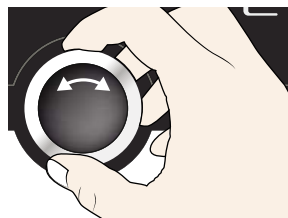

10. After the calibration procedure, the temperature measured by the reference instrument should now also be 30 °C.

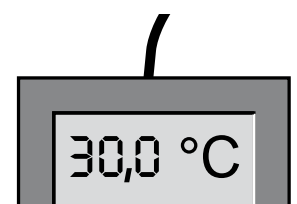
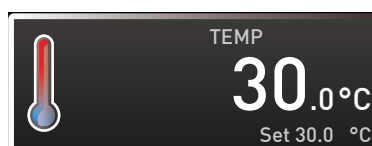

With Cal1, a calibration temperature below Cal2 can be programmed accordingly, and with Cal3, a temperature above. The minimum difference between the Cal values is 10 K.

**i** If all calibration values are set to 0.0 K, the factory calibration settings are restored.



## 8. Maintenance and service

### 8.1 Cleaning

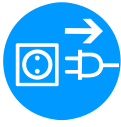

#### Warning!

Danger due to electric shock. Before doing any maintenance work, pull out the mains plug.



#### Warning!

In case of appliances of a certain size, you can get accidentally locked in, which is life-threatening. Do not climb into the appliance!



#### Caution!

Danger of cuts due to sharp edges. Always wear gloves when working in the chamber interior.

#### 8.1.1 Working chamber and metal surfaces

Regular cleaning of the easy-to-clean working chamber prevents build up of material remains that could impair the appearance and functionality of the stainless steel working chamber over time.

The metal surfaces of the appliance can be cleaned with normal stainless steel cleaning agents. Make sure that no rusty objects come into contact with the working chamber or with the stainless steel housing. Rust deposits can lead to an infection of the stainless steel. If rust spots should appear on the surface of the working chamber due to impurities, the affected area must be immediately cleaned and polished.

#### 8.1.2 Plastic parts

Do not clean the ControlCOCKPIT and other plastic parts of the appliance with caustic or solvent-based cleaning agents.

#### 8.1.3 Glass surfaces

Glass surfaces can be cleaned with a commercially available glass cleaner.

#### 8.1.4 Peltier cooling module

In order to guarantee perfect function and long lifetime of the Peltier cooling modules, it is absolutely essential that you remove dust deposits from the heat sink on the rear of the appliance (with a vacuum cleaner, paintbrush or bottle brush, depending on the amount).

To make cleaning easier, the cover can be removed after the screws have been loosened (Fig. 22).

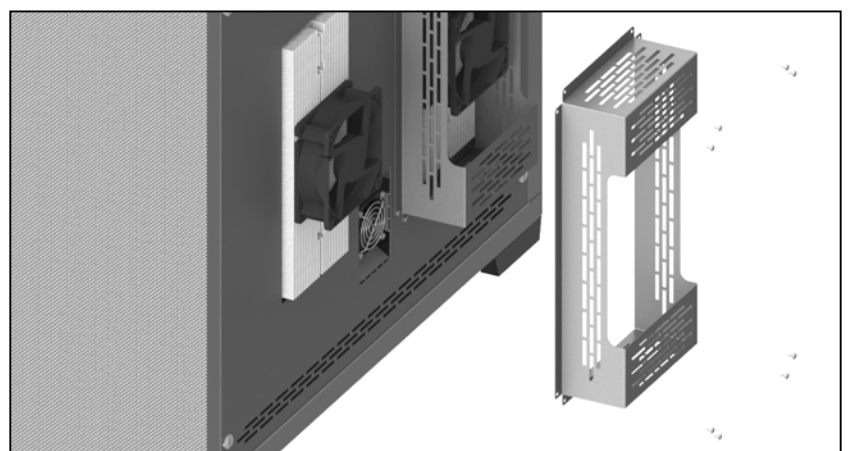

Fig. 22 Cover of the Peltier cooling modules on the rear of the appliance



## 8.2 Regular maintenance

Once a year, grease the moving parts of the doors (hinges and lock) with thin silicone grease and check that the hinge screws are not loose.

To guarantee perfect control, we recommend to calibrate the appliance once a year (see page 38).

## 8.3 Repairs and service

---



### Warning!

After removing covers, live parts may be exposed. You may receive an electric shock if you touch these parts. Disconnect the mains plug before removing any covers. Any work inside the appliance may only be performed by qualified electricians.

---



Repairs and service work are described in a separate service manual.

## 9. Storage and disposal

### 9.1 Storage

The appliance may only be stored under the following conditions:

- ▶ in a dry and enclosed, dust-free room
- ▶ frost-free
- ▶ disconnected from the power supply

### 9.2 Disposal

This product is subject to the Directive 2002/96/EC on Waste Electrical and Electronic Equipment (WEEE) of the European Parliament and of the Council. This appliance has been brought to market after August 13th, 2005 in countries which have already integrated this directive into their national laws. It may not be disposed of in normal household waste. For disposal, please contact your dealer or the manufacturer. Any appliances that are infected, infectious or contaminated with materials hazardous to health are excluded from return. Please also observe all other regulations applicable in this context.

Before disposing of the appliance, please render the door locking mechanism unusable, for example, to prevent playing children from being locked inside the appliance.

There is a lithium battery in the ControlCOCKPIT of the appliance. Remove it and dispose of it in accordance with the regulations in your country (Fig. 23).

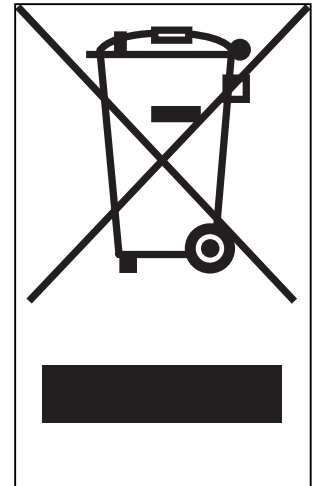

Fig. 23 Removing the lithium battery

#### Note for Germany:

The appliance may not be left at public or communal recycling or collection points.

# Index

---

- A**
  - Accessories 15
  - Activation key 25
  - Adjustment 38
  - Ambient conditions 14
  - Ambient temperature 15
  - Appliance error 29
  - AtmoCONTROL 3, 12
- B**
  - Basic device settings 31
  - Basic settings 31
- C**
  - Calibration 38
  - Carrying 16
  - Cause of errors 29
  - Chamber load 24
  - Changes 8
  - Cleaning 40
  - Clock time 36
  - Compensation correction value 39
  - Connections 11
  - ControlCOCKPIT 25
  - Customer service 2
- D**
  - Date and Time 35
  - Declaration of conformity 14
  - Decommissioning 42
  - Delivery 16, 17, 22
  - Digital backwards counter 26
  - Dimensions 14
  - Disposal 42
  - Door 23
  - Dust deposits 40
- E**
  - Electrical connection 11
  - Emergency 9
  - Ending operation 28
  - Error description 29
  - Error messages 29
  - Ethernet 12
  - Explosion protection 8
- F**
  - Forklift truck 17
- G**
  - Gateway 36
  - Grid 35
- H**
  - Hazards 7
  - Heat sink 40
- I**
  - Installation site 18
  - Intended use 8
  - Interfaces 11
  - Interior lighting 26
  - IP address 33
- L**
  - Language selection 32
  - Lighting 26
  - Loading the appliance 24
- M**
  - Maintenance 40
  - Malfunctions 9, 29
  - Manufacturer 2
  - Material 11
  - Max Alarm 35
  - Mechanical temperature monitoring 28
  - Menu 31, 35
  - Menu mode 31
  - Minimum clearances 18
- N**
  - Nameplate 12
  - Network 12, 33
- O**
  - Operating 23
  - Operating mode 25
  - Operating personnel 7, 23
  - Operating problems 29
  - Operation 23
- P**
  - Packaging material 17
  - Peltier cooling unit 40
  - Power failure 30
  - Product safety 7
  - Putting into operation 22
- R**
  - Rectifying errors 29
  - Regular maintenance 41
  - Remote control 36
- S**
  - Safety regulations 6, 10
  - Service 41
  - Servicing 41
  - Setting parameters 25, 32
  - Setting up 16, 18
  - Setting up options 19
  - Shelf 35
  - Slide-in unit 35
  - Storage after delivery 17
  - Switching off 28
  - Switching on 22
- T**
  - Technical data 13
  - Temperature 26
  - Temperature comparison 38
  - Temperature deviation 38
  - Temperature monitoring 27
  - Tilt protection 15, 20
  - Timer 26
  - Timer mode 35
  - Transport 16, 17
  - Transport damage 17
  - Türen einstellen 21
  - Turn control 25
  - TWW 28
- U**
  - Unit 35
  - Unpacking 17
- W**
  - Warning messages 29
  - Weight 13



**memmert**  
Experts in Thermostatics

Peltier-cooled incubator IPP

Storage cooled incubator IPS

D24034 | Date 06/2016

englisch

Memmert GmbH + Co. KG  
Willi-Memmert-Straße 90-96 | D-91186 Büchenbach  
Tel. +49 9122 925-0 | Fax +49 9122 14585  
E-Mail: [sales@memmert.com](mailto:sales@memmert.com)  
[facebook.com/memmert.family](https://facebook.com/memmert.family)  
Die Experten-Plattform: [www.atmosafe.net](http://www.atmosafe.net)