

OPERATING MANUAL



ViscoClock *plus*

VISCOSITY MEASURING DEVICE

SI Analytics
a **xylem** brand

Wichtige Hinweise:

Die Gebrauchsanleitung ist Bestandteil des Gerätes. Vor der ersten Inbetriebnahme bitte sorgfältig lesen, beachten und anschließend aufbewahren. Aus Sicherheitsgründen darf das Gerät ausschließlich für die beschriebenen Zwecke eingesetzt werden. Bitte beachten Sie auch die Gebrauchsanleitungen für eventuell anzuschließende Geräte.

Alle in dieser Gebrauchsanleitung enthaltenen Angaben sind zum Zeitpunkt der Drucklegung gültige Daten. Es können jedoch vom Hersteller sowohl aus technischen und kaufmännischen Gründen, als auch aus der Notwendigkeit heraus, gesetzliche Bestimmungen der verschiedenen Länder zu berücksichtigen, Ergänzungen an dem Gerät vorgenommen werden, ohne dass die beschriebenen Eigenschaften beeinflusst werden.

Important notes:

The operating manual is part of the device. Before initial operation of the unit, please carefully read and observe the operating instructions and keep it. For safety reasons the unit may only be used for the purposes described in these present operating instructions. Please also observe the operating instructions for the units to be connected

All specifications in this operating manual are guidance values which are valid at the time of printing. However, for technical or commercial reasons or in the necessity to comply with the statutory stipulations of various countries, the manufacturer may perform additions to the unit without changing the described properties.

Instructions importantes:

Le manuel d'utilisation fait partie de l'appareil. Prière de lire et d'observer attentivement le mode d'emploi avant la première mise en marche de l'appareil, et de le conserver. Pour des raisons de sécurité, l'appareil ne pourra être utilisé que pour les usages décrits dans ce présent mode d'emploi. Nous vous prions de respecter également les modes d'emploi pour les appareils à connecter.

Toutes les indications comprises dans ce mode d'emploi sont données à titre indicatif au moment de l'impression. Pour des raisons techniques et/ou commerciales ainsi qu'en raison des dispositions légales existantes dans les différents pays, le fabricant se réserve le droit d'effectuer des suppléments concernant l'appareil pour séries de dilution qui n'influencent pas les caractéristiques décrits.

Instrucciones importantes:

El manual de instrucciones forma parte del aparato. Antes de la operación inicial de aparato, lea atentamente y observe las instrucciones de operaciones y guárdelas. Por razones de seguridad, el aparato sólo debe ser empleado para los objetivos descritos en este manual de instrucciones. Por favor, observe las instrucciones de operación para los aparatos a conectar.

Todas las especificaciones en este manual de instrucciones son datos orientativos que son válidos en el momento de la impresión. No obstante, por motivos técnicos o comerciales, o por la necesidad de respetar las normas legales existentes en los diferentes países, el fabricante puede efectuar modificaciones del aparato sin cambiar las características descritas.

TABLE OF CONTENT

1	Technical Specifications of the ViscoClock <i>plus</i>.....	35
1.1	Intended Use	35
1.2	Specifications of the ViscoClock <i>plus</i>	36
1.3	Description of the device	37
1.4	Warnings and safety information.....	38
1.5	Mode of operation	39
2	Unpacking and Setup	39
3	Commissioning.....	40
3.1	Viscometer models to be used.....	40
3.2	Selection of the viscometer	41
3.3	Preparation of the sample	42
3.4	Place the viscometer into the ViscoClock <i>plus</i>	43
3.5	Place the ViscoClock <i>plus</i> into the thermostat bath	44
3.6	Connection the ViscoClock <i>plus</i>	44
3.7	Connection of a USB drive or a printer to the ViscoClock <i>plus</i>	44
3.7.1	Connection of a USB drive	45
3.7.2	Connection of the printer TZ 3863	45
3.7.3	Simultaneous connection of a USB drive and the printer TZ 3863.....	46
3.8	Prepare for measurement	47
3.9	Start measurement.....	48
3.10	Reading the flow time	49
3.11	Standby and switching off	49
3.12	Viscosity calculation	49
3.13	Evaluation example	50
4	Description and use of software	51
4.1	Display	51
4.2	Keys.....	51
4.3	Set time / activate sounds	51
4.4	Set up sample or viscosity numbers	52
4.5	Start measurement.....	52
4.6	Stop measurement.....	52
4.7	Save or print measurements	53
4.7.1	Internal memory	53
4.7.2	Create PDF document.....	53
4.7.3	Printing measuring results.....	54
4.7.4	Simultaneous printing and creating of a PDF document.....	54
4.7.5	Documentation format	54
4.7.6	Tips for using the USB interface	55
4.7.7	Idle mode.....	55
4.8	Notes and error messages.....	55
4.9	Personalizing the header of a PDF document	55
4.10	Master Reset	56
4.11	Software update	56
5	Maintenance.....	57
5.1	General notes	57
5.2	Cleaning	57
5.3	Inspection	57
5.4	Repair	57
6	Faults and error messages	58
6.1	Faults.....	58
6.2	Error messages	60

7	Guarantee	62
8	Storage and transport	62
9	Recycling and disposal	62
10	Accessories and Spare Parts	62
10.1	Accessories	62
10.2	Spare parts.....	62

Notes to the Manual

The provided manual will allow you the proper and safe handling of the product. For maximum security, observe the safety and warning instructions in the Instructions.

The pictogram  has the following meaning:

- Warning of a general danger to personnel and equipment.
- Non-compliance results (can result) in injury or material damage.

 Important information for device use.

 Refers to another part of the operating manual.

Status at time of printing

Advanced technology and the high quality of our products are guaranteed by a continuous development. This may result in differences between this operating manual and your product. We cannot exclude mistakes. We are sure you understand that no legal claims can be derived from the information, illustrations and descriptions.

A potentially more recent version of this manual is available on our internet website at www.si-analytics.com. The German version is the original version and binding in all specifications.

Copyright

© 2016, Xylem Analytics Germany GmbH

Reprinting - even as excerpts - is only allowed with the explicit written authorization. Printed in Germany.

1 Technical Specifications of the ViscoClock *plus*

1.1 Intended Use

The ViscoClock *plus* is an electronic viscosity measuring device.

⚠ Use only viscometers of the brand SI Analytics® (Ubbelohde, Micro Ubbelohde or Micro Ostwald)!

The ViscoClock *plus* automatically measures the time which a liquid requires to flow from the upper to the lower timing mark of the measurement bulb through the capillaries of the viscometer. You can measure all transparent liquids – for which the viscometer used is suited according to its operating instructions – with a temperature of - 40°C up to a max. of + 150°C.

⚠ The relevant regulations regarding the handling of the substances used have to be observed: The Decree on Hazardous Matters, the Chemicals Act, and the rules and information of the chemicals trade.

For the measurement of the **relative** viscosity, all calibrated or uncalibrated DIN, ISO, ASTM, Micro Ubbelohde and Micro Oswald viscometers can be used.

To measure the absolute kinematic viscosity, you **must** use viscometers that have been calibrated for automatic measurements!

i As a principle, the measurement of the flow time should be performed in a transparent SI Analytics® thermostat bath in which the ViscoClock *plus* is fixed by the manual measurement insert of the bath and which is suitable for the intended temperature range.

For tempering in the thermostat (tempering range: - 40 to + 150°C), the following tempering liquids are permitted:

- Water
- Alcohol-water (e.g. ethanol, methanol)
- Glycerin
- Paraffin oil
- Silicone oil
- Glycol

For temperature ranges higher than 90°C, we recommend using silicone oils as a tempering liquid.

⚠ The ViscoClock *plus* must not be used for other work than the above-mentioned.

The manufacturer will not be liable for any damage resulting from this.

⚠ The ViscoClock *plus* must only be used by authorized persons whose training or knowledge and experience ensure proper operation of the device and who are informed about the dangers!

On the part of the user it has to be ensured that the persons entrusted with the use of the ViscoClock *plus* are experts in the handling of substances used in the environment and in the Device or that they are supervised by specialized persons, respectively.

⚠ Not suitable for use in explosive environments!

⚠ Always attach the silicone cap perpendicular onto the ventilation tube! With a lateral load on the ventilation tube, the glass tube may break!

⚠ Do not pump the sample liquid into the measuring sphere using the manual pump after pressing the start key! Sample liquid will enter the unit via the ventilation tube. This results in damage to the unit!

1.2 Specifications of the ViscoClock *plus*

(Release: 19. December 2016)

- CE sign:**  As per the low voltage directive 2014/35/EU;
test basis EN 61 010-1: 2011-07 for laboratory devices
As per the EMC directive 2014/30/EU; test basis EN 61 326 Part 1: 2012
As per the EMC directive 2011/65/EU; test basis EN 50 581: 2013-02
FCC mark
- Country of origin:** Germany, Made in Germany
- Measuring range time:** up to 999.99 s; resolution: 0,01 s
Accuracy of time measurement: ± 0.01 s / ± 1 digit; but not more precise than 0.1 %; indicated as measuring uncertainty with a confidence level of 95%
- Measuring range viscosity:**
0,35... 10,000 mm²/s (cSt)
The absolute, kinematic viscosity is also dependent on the uncertainty of the numeric value of the viscometer constants and on the measuring conditions, specifically the measuring temperature.
- Types of viscometers:** DIN, ISO, ASTM-Ubbelohde viscometer; Micro Ubbelohde viscometer and Micro Ostwald viscometer of the brand SI Analytics®
- Voltage supply:** via external multi-range power supply 100 - 240 V~, 50/60 Hz
Input: 9 Volt DC, 450 mA
Power Input: 4 W

Corresponds to protective system III, protection class for dust and humidity
Protection type for dust and moisture IP 50 as per DIN 40 050

 Use only the included power supply TZ 1858 (labeled: FW 7650/ 9) or another released power supply by the manufacturer!
- Materials:**
Casing: Polypropylene (PP)
Stand: Polyphthalamide (PPA)
Seals: Silicone
- Dimensions:** ~ 515 x 90 x 30 mm (H x W x D)
Weight: ~ 450 g; power supply approx. 220 g
- Environment:**
Ambient temperature: + 10... + 40 °C for storage and transport
Operating temperature: Stand: - 40 ... + 150 °C
electronic measuring unit: + 10 ... + 40°C

Humidity as per EN 61 010, part 1:
80% for temperatures of up to 31°C, linear decrease to up to 50% relative humidity at a temperature of 40°C
- Interfaces:** USB Host to connect a printer or a USB drive
USB OTG to connect a PC to document the data,
to connect a printer or a USB drive
- Plug connections:** Socket for low voltage connection:
Hollow plug (5.5 mm, interior contact $\varnothing = 2.1$ mm, plus pole on pin contact, connection of a multi-range power supply TZ 1858)
USB-B mini socket (OTG)
USB-A socket (host)

 **Not suitable for use in explosive environments!**

 The ViscoClock *plus* can be used in all SI Analytics® transparent thermostats.

1.3 Description of the device

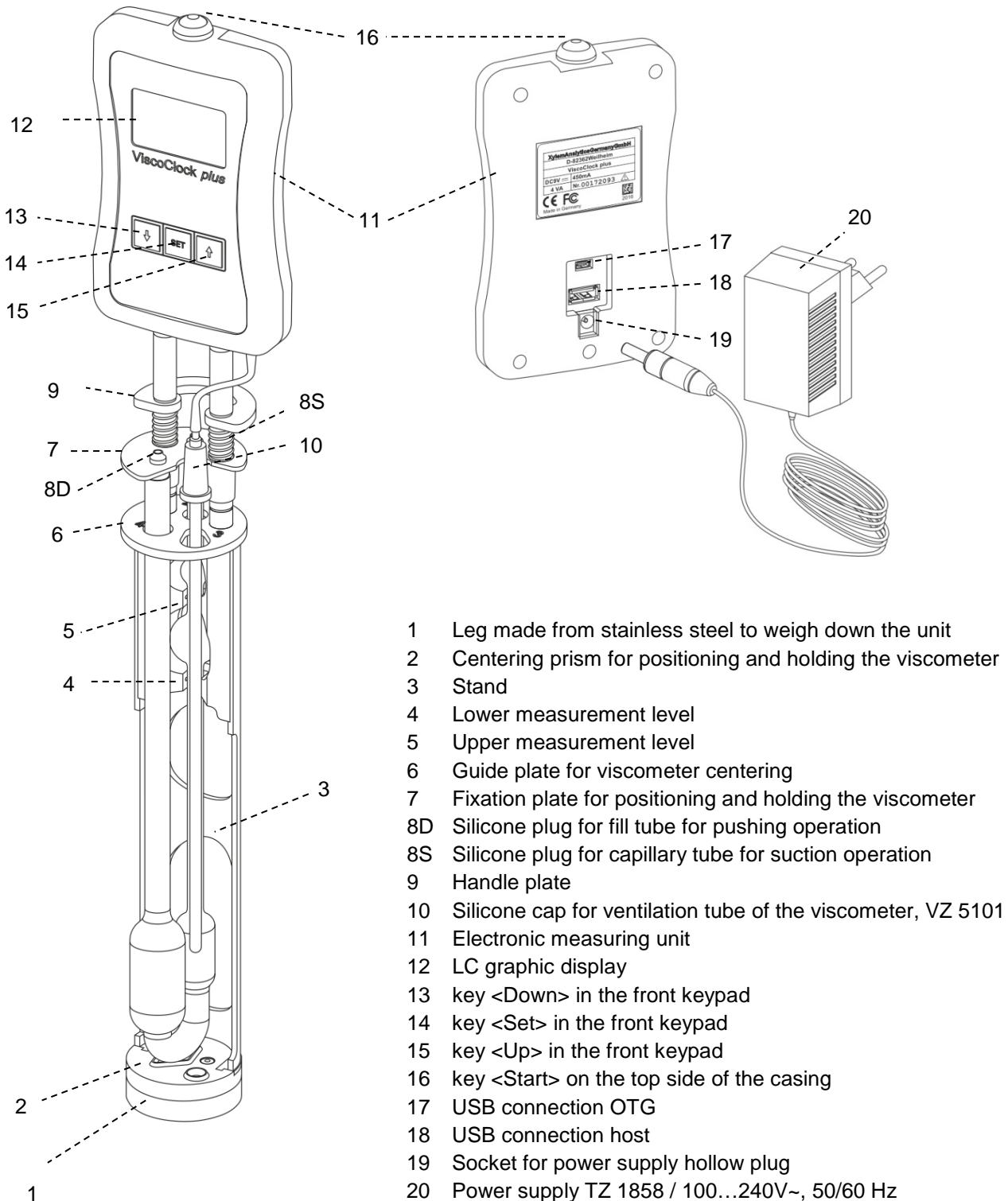



Fig. 1 Description of the ViscoClock plus

1.4 Warnings and safety information

The ViscoClock *plus* unit is protected as per protection class III.

It was manufactured and tested according to DIN EN 61 010 - 1, Part 1, "**Protective Measures for electronic measurement devices and control devices**" and has left the factory in an impeccable condition as concerns safety technology. In order to maintain this condition and to ensure safe operation, the user should observe the notes and warning information contained in the present operating instructions. Development and production is done within a system which meets the requirements laid down in the DIN EN ISO 9001 standard.

 Please also note the corresponding Operating instructions for the devices to be connected.

 For reasons of safety, the device must only be used for the range of application described in the present operating instructions. Nonobservance of the intended proper use of the device may result in personal injury or damage to property.

 For reasons of safety, the unit and the power supply TZ 1858 must be opened by authorized persons only; this means, for instance, that work on electrical equipment must only be performed by qualified specialists. **In case of nonobservance of these provisions the titrator and the power supply may constitute a danger: electrical accidents and a fire hazard!** Moreover, in the case of unauthorized intervention in the titrator or the power supply, as well as in the case of negligently or deliberately caused damage, the warranty will become void.

 Prior to switching on the unit, it has to be ensured that the operating voltage matches the mains voltage. The operating voltage is indicated on the type plate (bottom side of the unit and backside of the power supply). **Nonobservance of this provision may result in damage to the unit and the power supply, or in personal injury or damage to property!**

 **If it has to be assumed that safe operation is impossible, the unit has to be taken out of operation and secured against inadvertent putting to operation!** For this, switch off the unit, pull plug of the mains cable out of the power supply, and remove the meter from the work station.

Examples for the assumption that a safe operation is no longer possible,

- if the package is damaged,
- if the unit shows visible damages,
- if the power supply TZ 1858 shows visible damages,
- if the unit does not function properly,
- if liquid has penetrated into the casing.
- if the unit has been altered technologically or if unauthorized personnel tried or succeeded to open the instrument as attempt to repair it.

In case that the user operates such a device, all thereof resulting risks are on the user.

 The unit must not be stored or operated in moist rooms.

 **The relevant regulations regarding the handling of the substances used have to be observed:** The Decree on Hazardous Matters, the Chemicals Act, and the rules and information of the chemicals trade. On the part of the user it has to be ensured that the persons entrusted with the use of the unit are experts in the handling of substances used in the environment or that they are supervised by specialized persons, respectively.

 For all work with chemicals: **Always wear protective goggles!** Please observe the memorandums of the employer's liability insurance associations and the safety data sheets of the manufacturers.

 **Please observe the standard regulations and Standards for capillary-viscosity measurements!** The manufacturer of the unit has a list of the national and international standards available.

 **Always attach the silicone cap perpendicular onto the ventilation tube! With a lateral load on the ventilation tube, the glass tube may break!**

 **Do not pump the sample liquid into the measuring sphere using the manual pump after pressing the start key!** Sample liquid will enter the unit via the ventilation tube. **This results in damage to the unit!**

1.5 Mode of operation

The ViscoClock *plus* automatically measures the flow time of a liquid in an SI Analytics® viscometer to determine the relative and kinematic (absolute) viscosity. The time measured is the time which a liquid requires to flow from the upper to the lower measurement mark of the measurement bulb through the capillaries of the viscometer. The detection of the liquid takes place by the capturing of the liquid meniscus by means of IR light barriers. The measurement takes place in an SI Analytics® thermostat bath (e.g. transparent thermostats of the series CT 72).

i The switch of the viscometer is performed outside the thermostat bath!

The ViscoClock *plus* consists of a stand for accommodating the viscometer and the electronic measuring unit. The two IR light barriers for the meniscus detection are integrated in the plastic stand (PPA). The electronic measuring unit is built into a polypropylene casing. Owing to the use of heat-carrier liquids as bath media, color changes may occur on the stand, which do not affect the measurement accuracy.

2 Unpacking and Setup

Check packing for damage. In case of damage contact your supplier.

Scope of delivery: ViscoClock *plus*
 Power supply **TZ 1858**
 Primary adapter for Europe
 Primary adapter for USA
 Manual pump "pressure" **VZ 6550**
 Instructions for Use

i There are no viscometers included in the scope of delivery.

Remove the ViscoClock *plus*, the power supply TZ 1858 and the manual pump VZ 6550 from the packaging.

Place the ViscoClock *plus* in a dry environment on a plane surface.
 Ambient temperature: + 10 ° C ... + 40°C (see  **1.2 Specifications**).

i Owing to the small stand foot and the relatively high center of gravity we recommend storing the ViscoClock *plus* always in a horizontal position outside of the bath.

⚠ Use only the included power supply TZ 1858 (labeled: FW 7650/ 9) or another released power supply by the manufacturer!

⚠ Place the power supply easily accessible in order to be able to remove the ViscoClock *plus* anytime easily from the power circuit.

3 Commissioning

3.1 Viscometer models to be used

The following viscometer models can be used in the ViscoClock *plus*:

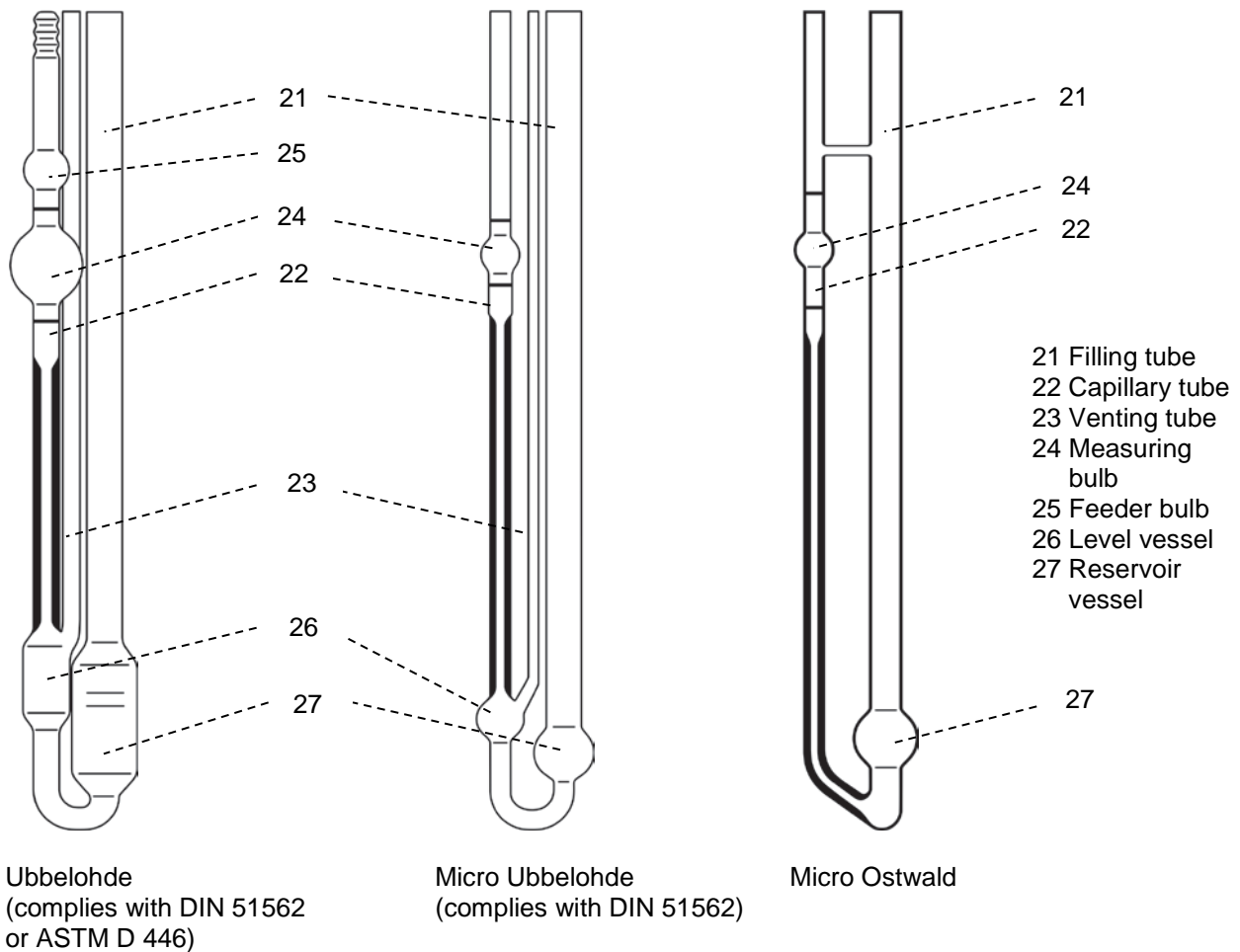

Fig. 2 Description of the usable viscometer models

⚠ Use only original SI Analytics® viscometers! If you are using viscometers by other manufacturers the function of the ViscoClock *plus* cannot be guaranteed. Non-compliance can lead to personal injury or damage to the equipment.

3.2 Selection of the viscometer

i The flow time of the liquid to be measured depends on the size of the capillaries. The capillary size of the viscometer should be selected in such a manner that flow times greater than 100 s result¹.

We only guarantee original SI Analytics® viscometers that they will fit into the ViscoClock *plus* and that the calibration of the calibrated viscometer models yields correct measured values.

Viscometer	Type No.	uncalibrated	Calibrated for measurements		Viscosity determination	
			manual	automatic	relative	absolute
DIN-Ubbelohde	532...	-	-	✓	✓	✓
DIN-Ubbelohde	501...	-	✓	-	✓	-
DIN-Ubbelohde	530...	✓	-	-	✓	-
ASTM-Ubbelohde	527...	-	-	✓	✓	✓
ASTM-Ubbelohde	525...	-	✓	-	✓	-
ASTM-Ubbelohde	526...	✓	-	-	✓	-
Micro Ubbelohde	537...	-	-	✓	✓	✓
Micro Ubbelohde	536...	-	✓	-	✓	-
Micro Ubbelohde	538...	✓	-	-	✓	-
Micro Ostwald	517...	-	-	✓	✓	✓
Micro Ostwald	516...	-	✓	-	✓	-
Micro Ostwald	518...	✓	-	-	✓	-

Table 1 List of viscometers for the selection of viscometers that are suitable to measure the flow time for the application and to determine the viscosity by means of the ViscoClock *plus*.

i Based on their construction, viscometers type 502 41, type 502 43 and type 502 50 are not suitable!

i To measure the absolute kinematic viscosity, you **must** use viscometers that have been calibrated for automatic measurements!

i Prior to the first use, we recommend a cleaning procedure as per DIN 51 562, part 1. After this, the viscometer must be dried and free of dust!

¹ To measure the absolute (kinematic) viscosity with Ubbelohde viscometers, many standards assume minimum run times of 200 seconds. Shorter run times are permitted if you use Micro Ubbelohde viscometers or for measuring relative viscosities.

3.3 Preparation of the sample

i If the samples to be measured (measuring liquids) may contain particles, they must be filtered prior to being introduced into the viscometer.

For low viscosity liquids, the following filters are recommended

a) Low-viscosity liquids:

- Glass filter, e.g. Duran[®] porosity 2 to 4 (10...100 µm)
- Syringe adapter filters (laboratory suppliers) that are used in combination with disposable syringes with Luer connections. A pore width of approx. 5 µm is suitable for use in capillary viscometry. When selecting suitable filters, you must pay attention to the chemical resistance against the samples to be measured.

⚠ Syringe adapter filters are intended for use by pushing; i.e. the sample is filtered from the syringe through the filter. **If this is not performed correctly, there is a risk of the syringe filter detaching itself from the syringe due to the created pressure and of the sample being spilled!** Therefore, you should use syringes with Luer lock connections that are fixed to the syringe filters. Hazardous liquids should not be filtered by pushing through the filter holder for safety reasons.

- Especially for aggressive or toxic liquids used in polymer analytics, SI Analytics[®] offers the filtering system ProCleanII (VZ 7090), where the sample is filtered by suction through a small filtering plate. Here, there is no risk of spilling during filtering.

b) High-viscosity liquids:

- Sieve with 0.3 mm mesh size

Fill the measuring liquid through the fill tube (21) into the reservoir vessel (27).

i Also see the respective operating manual of the viscometer.

3.4 Place the viscometer into the ViscoClock *plus*

Press the guidance plate (7) up against the handle plate (9) (see  Fig. 3).

- The following applies to the use of Ubbelohde and Micro Ubbelohde viscometers:

- Insert the viscometer sloped through the guidance plate (6), and then insert it vertically into the centering (2) prism.
> The capillary tube of the viscometer is located underneath the IR light barriers.
- Lower the guidance plate (7).
- Check for correct seating of the silicone plug on the fill tube (21) (silicone plug 8D) and capillary tube (22) (silicone plug 8S).
- The viscometer is now seated.

• **Attach the silicone cap (10) to the ventilation tube at a 90° angle!**

 **With a lateral load on the ventilation tube, the glass tube may break!**

- The following applies to Micro Oswald viscometers:

- Insert the Micro Ostwald viscometer into the stand (3) of the ViscoClock *plus* so that the fill tube is inserted into the elongated hole of the guidance plate (6).
- Lower the guidance plate (7).
- With Micro Ostwald viscometers, the manual pump set "suction" VZ 6554 is required.

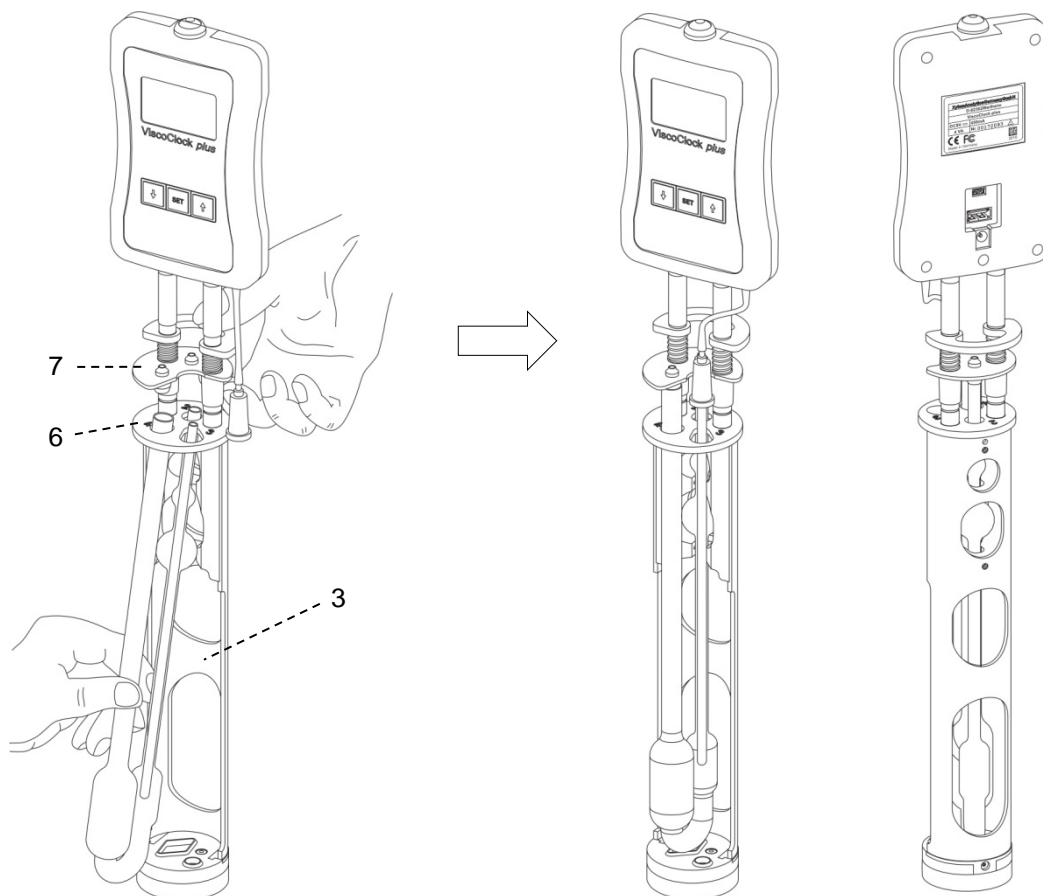



Fig. 3 Inserting the viscometer into the ViscoClock *plus*

3.5 Place the ViscoClock *plus* into the thermostat bath

The transparent thermostat has to be equipped with a VZ 5402 manual measuring insert in order to accommodate the ViscoClock *plus*.

Insert the ViscoClock *plus*, including the viscometer filled with measuring liquid, into the manual measuring insert of the thermostat bath (see  Fig. 4).

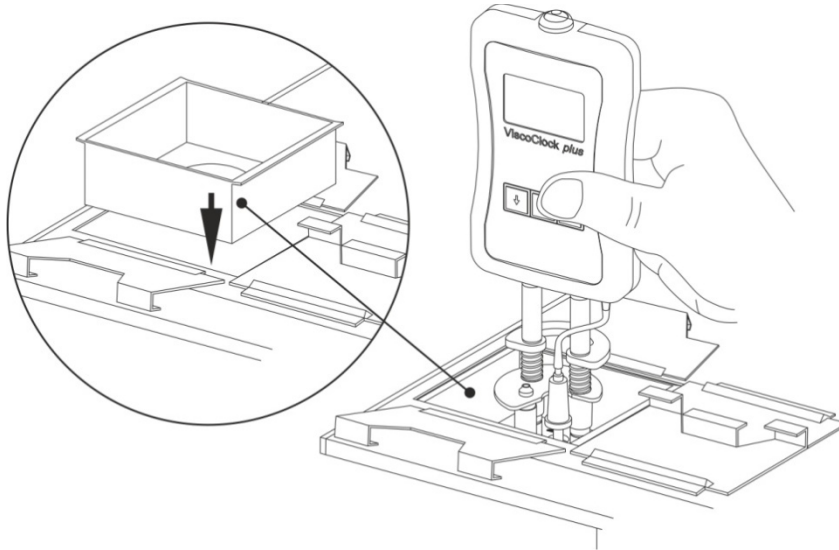





Fig. 4 Placement of the ViscoClock *plus* into the thermostat bath

3.6 Connection the ViscoClock *plus*

 Prior to plugging the power supply (20) into the socket, check that the operating voltage matches the power voltage. The operating voltage is indicated on the type plate (bottom side of the unit and backside of the power supply). **Nonobservance of this provision may result in damage to the unit and the power supply, or in personal injury or damage to property!**

- Plug the 9 VDC jack plug into the socket (19) on the back of the electronic measuring unit (11). (see  1.3)
- Plug the power supply (20) into the mains socket.

 Use only the included power supply TZ 1858 (labeled: FW 7650/ 9) or another released power supply by the manufacturer!

 Place the power supply easily accessible in order to be able to remove the ViscoClock *plus* anytime easily from the power circuit.

3.7 Connection of a USB drive or a printer to the ViscoClock *plus*

On the back of the electronic measuring unit (11) there are two USB connectors:

- USB type A (18, Host)
- USB Mini-B (17, OTG).

3.7.1 Connection of a USB drive

To transfer the measured data to a USB drive, this can simply be connected to the USB-A connector (18). As an alternative, the connection can also be made via the USB Mini-B socket (17) via an optional USB OTG adapter cable VZ6570.

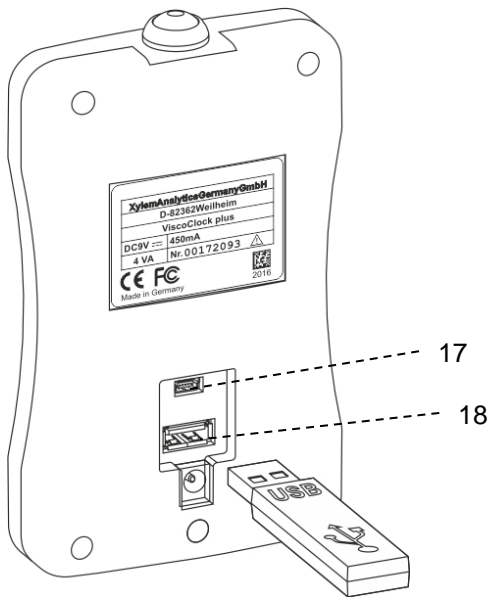

Fig. 5 Connection of a USB drive to the ViscoClock *plus*

3.7.2 Connection of the printer TZ 3863

To print the measured data to the printer TZ 3863, this can simply be connected to the USB-A connector (18). As an alternative, the connection can also be made via the USB Mini-B socket (17) via an optional OTG adapter cable VZ6570.

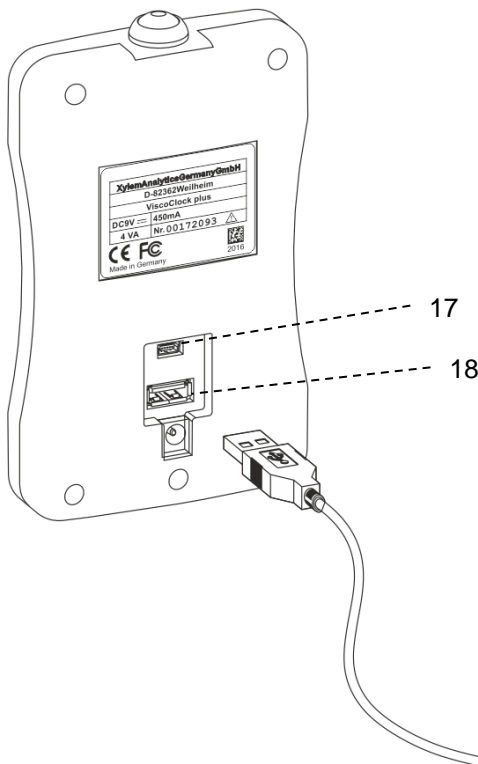

Fig. 6 Connection of a printer to the USB A connector on the ViscoClock *plus*

3.7.3 Simultaneous connection of a USB drive and the printer TZ 3863

For the simultaneous connection of both USB drives and the printer, one device is connected to the USB-A connector (18) and the other device is connected to the USB Mini-B connector (17) via the OTG adapter cable VZ6570 (optional accessory).

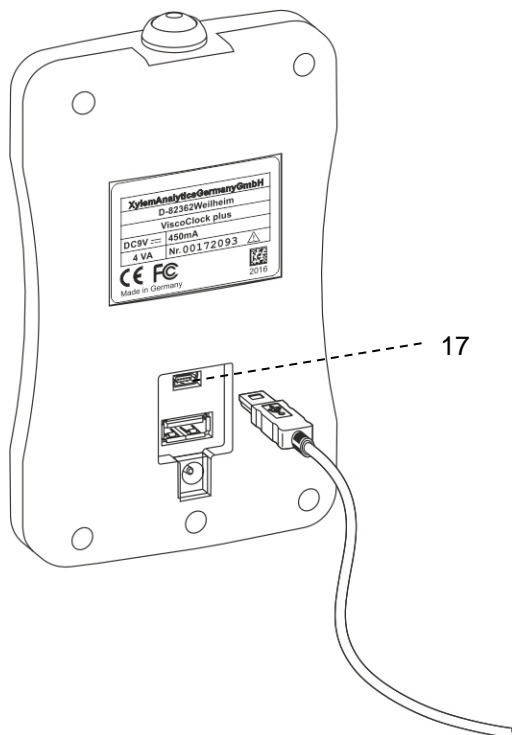



Fig. 7 Connection of a peripheral via USB OTG cable VZ6570 to the USB Mini-B connector (17) of the ViscoClock plus

3.8 Prepare for measurement

- Wait for the tempering time of the sample in the thermostat bath, depending on the application type, 5...15 minutes
- Pumping the sample into the measuring sphere of the viscometer:
The liquid should be pumped to approx. 1 - 2 cm above the top measuring level.
For Ubbelohde viscometers, the feeder bulb (24) is located above the measuring bulb (25) (see  **Fig. 2**). This feeder bulb should be filled with liquid to at least half by the end of the pumping process.

 **The pumping process must be ended in due time to prevent sample liquid from spilling out of the viscometer!**

Description of the handling:

Manually place the adapter (28) of the manual pump onto the silicone plug (8), either

- (a) with pressure applied to the silicone plug (8D) above the filling tube (see  **Fig. 8**)

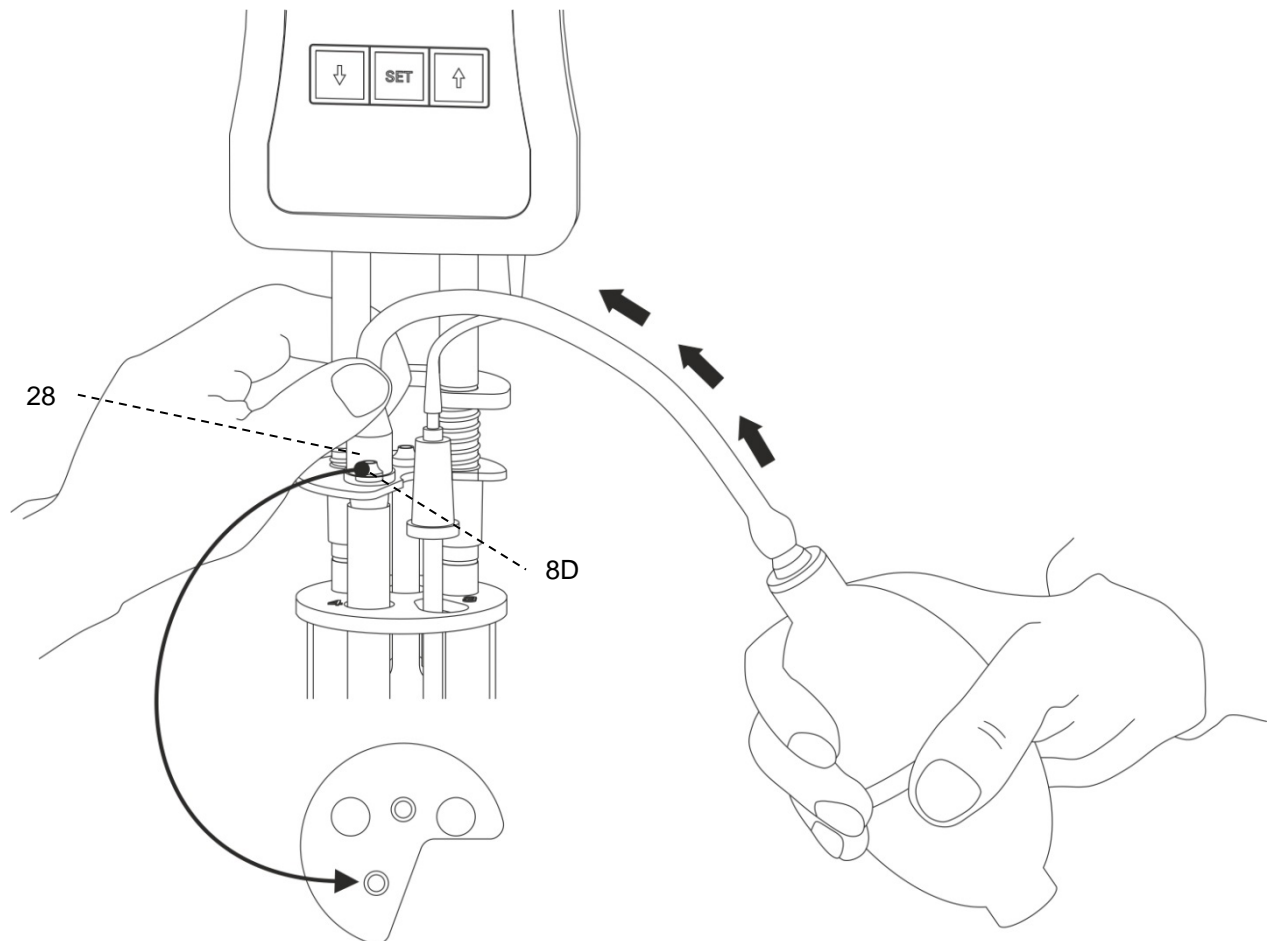





Fig. 8 Pressure mode liquid handling with manual pump VZ 6550

 The pressure mode is the standard procedure.
The manual pump VZ 6550 required for this is part of the delivery scope of the ViscoClock *plus*.

 **Do not pump the sample liquid into the measuring sphere using the manual pump after pressing the start key! (16)!** The installed ventilation valve of the ViscoClock *plus* is open. When using Ubbelohde viscometers (with ventilation tube) and for pushing operation, the sample would be pumped into the ViscoClock *plus* via the ventilation tube. **This results in damage to the unit!**

(b) on silicone plug (8S) above the capillary tube (22) for suction operation (see  Fig. 9)

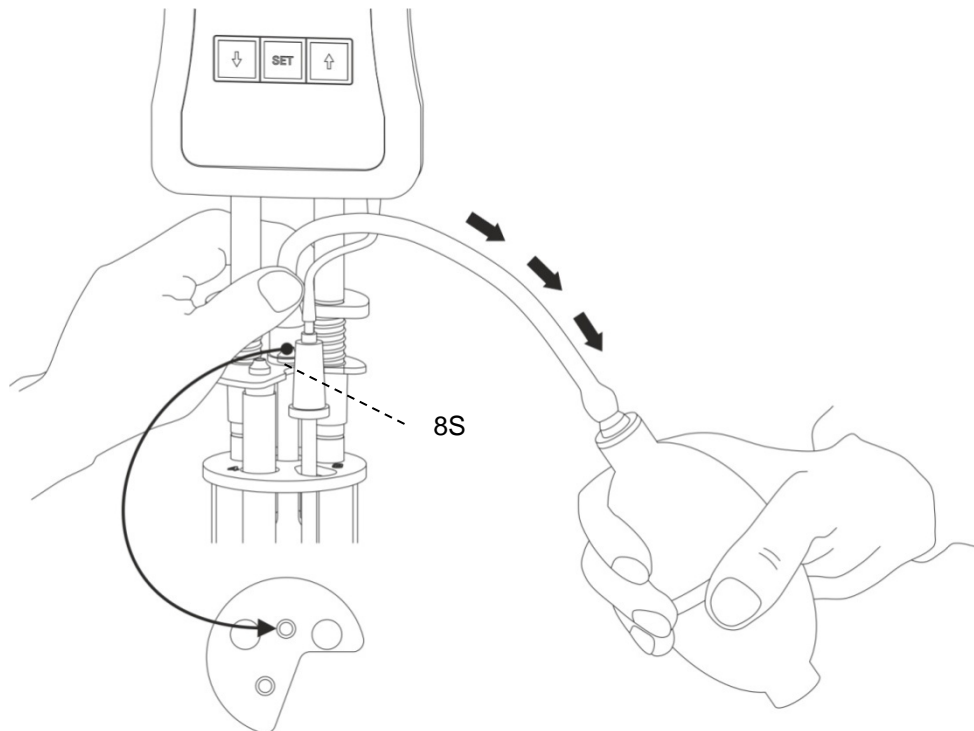

Fig. 9 Suction mode liquid handling with manual pump VZ 6554

i The suction operation with manual pump VZ 6554 (optional accessory, not included in the scope of delivery), is recommended especially for aggressive liquids which must never enter the thermostat bath inadvertently. Furthermore, this operating mode is recommended for foaming samples.

3.9 Start measurement

Remove the adapter (28) of the manual pump.

⚠ Considering that the measurement liquid will immediately start flowing down, the <START> key (16) must be pressed immediately!

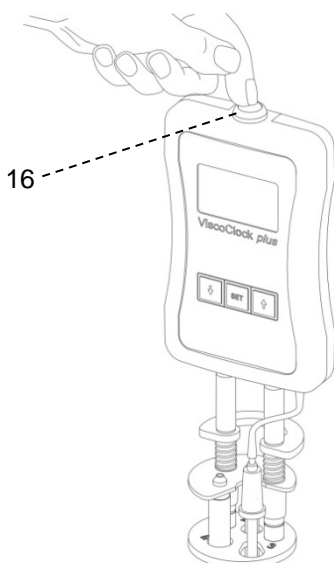

Fig. 10 Start measurement

This will:

- set the display to zero
- release the venting tube (1) (only applies to Ubbelohde viscometers)
- trigger the measurement

Once the meniscus of the measuring liquid runs through the upper measurement level (5), the time measurement begins and when it passed the lower measuring level (4), time measurement ends.

i Do not touch the ViscoClock *plus* during the measurement process, as the vibration may cause measurement errors!

3.10 Reading the flow time

The ViscoClock *plus* stops the time as soon as the meniscus of the measuring liquid passes the lower measuring level (4).

Read the flow time on the display (12) in seconds. If a USB drive or a printer is connected, the measured value can also be documented (see  4.7)

i The evaluation of the flow time is done as per

-  3.12, 3.13
- the respective operating manual of SI Analytics® viscometers, and,
- if necessary by referencing the tables of the Hagenbach corrections (kinematic energy correction)

i **Do not start the next measurements until the capillary has run dry!**

Otherwise, there is a risk of the formation of bubbles and thus erroneous measurements!

i A description of the internal software of the ViscoClock *plus* can be found in  **Chapter 4**.

3.11 Standby and switching off

If the ViscoClock *plus* is not used for a duration of 60 minutes, it will switch to standby mode. Pressing any key will awaken the ViscoClock *plus* from the standby mode.

The ViscoClock *plus* is switched off by unplugging the power supply (20) from the wall socket or by removing the hollow plug from the socket (19) of the ViscoClock *plus*.

3.12 Viscosity calculation

In order to calibrate a viscometer, please read the document "Visco_QS", which is attached to your SI Analytics® viscometer.

The result obtained using capillary viscometry is kinematic viscosity, measured in the unit of mm²/s (formerly Centistokes, cSt). Considering that viscosity is highly dependent on temperature, the measuring temperature has to be maintained accurately and included in the result (± 0.02 K).

The correction time indicated in the tables for Hagenbach corrections (kinematic energy correction, Δt_H) must be subtracted for the different viscometers. The Hagenbach corrections can be found in the manual for the viscometer or the attached documents. Intermediate values can be interpolated.

As the calculation of the Hagenbach corrections bears a high uncertainty due to physical reasons, the value of the correction should be a max. of 2% of the flow time, depending on the requirements of the measuring accuracy.

For absolute measurements of viscosity, the corrected flow time multiplied by the constants indicated in the viscometer certificate K results immediately in the kinematic viscosity in the unit mm^2/s .

$$\nu = K(t - \Delta t_H)$$

Relative viscosity is the quotient of the viscosities of a solution and the pure solvent. This has a high significance in the evaluation of plastics. In polymer analytics, further parameters are derived from the relative viscosity, such as the specific and inherent viscosity as well as the viscosity number and the Fikentscher K value.

3.13 Evaluation example

DIN Ubbelohde viscometer type no. 532 10, calibrated for automatic measurements.

Capillaries no. I

Constant

$$K = 0,009987 \text{ mm}^2/\text{s}^2$$

Flow time (averaged)

$$t = 180,00 \text{ s}$$

Hagenbach correction for 180.00 s

$$\Delta t_H = 0,30 \text{ s (correction table in the manuals for viscometer)}$$

Kinematic viscosity

$$\begin{aligned} \nu &= K(t - \Delta t_H) \\ &= 0,009987 \text{ mm}^2/\text{s}^2 \cdot (180,00 \text{ s} - 0,30 \text{ s}) \\ &= 1,795 \text{ mm}^2/\text{s}^* \end{aligned}$$

4 Description and use of software

4.1 Display

The main screen (📄 Fig. 11) of the ViscoClock *plus* displays all relevant information clearly on a graphics display.

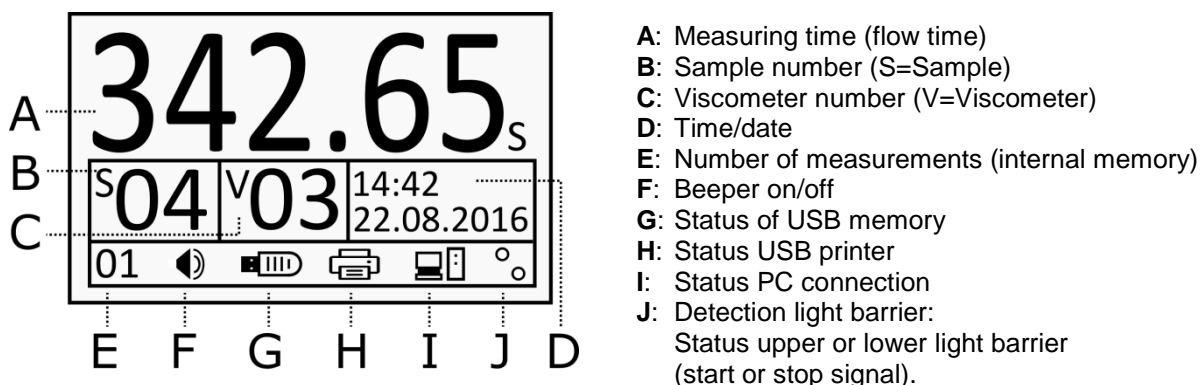

Fig. 11 Display ViscoClock *plus*

The flow time (max. 999.99 s) is displayed in large digits in the upper section (A).

Below this, there are important parameters for the documentation of the measuring results, such as sample and viscosity number as well as the date and time (B to D).

The bottom line is used to display the status information (E to J).

4.2 Keys

The ViscoClock *plus* is operated via a total of 4 keys:

<START> (16): Start/stop measurement

<SET> (14): Save/print, set/confirm parameters

<↓> (13): elect sample number, decrease parameters

<↑> (15): Select viscosity number, increase parameters

i The following sections will show more information about the different key functions.

4.3 Set time / activate sounds

If you press the <SET> key for a long time, you will be in the setup mode.

The selected parameter will blink and can be changed via the <↑> and <↓> keys.

You press <SET> again: the set parameter is taken over and you will get to the next parameter.

After setting the time (D), the last parameter will be the activation of the beeper (F).

i If there is no new entry for 8 seconds, the value is saved automatically and the mode will be exited.

For early saving, press the <SET> key.

4.4 Set up sample or viscosity numbers

To set up the sample number, press the <↓> key.

The sample number (**B**) will blink and then you can use the <↑> and <↓> keys to set up numbers between 0 and 99.

To set up the viscosity number, press the <↑> key.

The viscosity number (**C**) will blink and then you can use the <↑> and <↓> keys to set up numbers between 0 and 99.

- i** If there is no new entry for 8 seconds, the value is saved automatically and the mode will be exited.

For early saving, press the <SET> key.

i **The sample number is reset to "00" if the power supply is disconnected.**

This is the intention as the sample is usually changed when the power supply is (intentionally) disconnected. The automatic reset of the sample number to "00" prevents a set up sample number from remaining in place inadvertently for the subsequent samples. Contrary to this, the viscometer number will remain intact after disconnecting the power supply in order to save having to reset the viscometer number in cases where the same viscometer is used repeatedly.

4.5 Start measurement

Also see  3.9

Pressing the <START> key (16) starts the measurement and the possibly previously shown run time is reset to 0.00 s.

An animated stop watch to the left of the run time (**A**) signals the waiting for the meniscus to pass through the upper measurement level.

⚠ Do not pump the sample liquid into the measuring sphere using the manual pump after pressing the start key! (16)! The installed ventilation valve of the ViscoClock *plus* is open. When using Ubbelohde viscometers (with ventilation tube) and for pushing operation, the sample would be pumped into the ViscoClock *plus* via the ventilation tube. **This results in damage to the unit!**

As soon as the meniscus passes the upper or lower light barrier, the stop watch starts or stops the measurement of the flow time. The max. run time is 999.99 s.

When the lower light barrier is passed, the ventilation valve of the ViscoClock *plus* is closed again.

If no meniscus passes the upper light barrier for 120 seconds after the <START> key is pressed, the measurement is terminated and the valve is closed.

4.6 Stop measurement

A measurement that has already been started can be stopped by pressing the <START> key (16) one more time.

i The measuring result is not saved.

4.7 Save or print measurements

4.7.1 Internal memory

The ViscoClock *plus* has an internal memory (clipboard) for up to 99 measuring results.

Every carry out measurement is saved in this memory and remains intact even after the supply voltage is disconnected.

The number of saved measured values is shown on the left bottom part of the display (**E**).

Only after measurements are exported to a USB drive or printed by the user using the **<SET>** key (see subsequent sections), this memory will be deleted.

In order to manually delete this memory, hold the **<↓>** key for at least 3 s.

The measured value counter (**E**) starts to blink.

Now, you can delete the memory using the **<START>** key.

The deletion of the memory can be seen by the display showing "00".

i If the internal memory is full, newly taken measurements cannot be saved. The log file (CSV) on the USB drive is not affected by this restriction. In case of 10 or less memory slots, there will be a reminder (Code: 0x20003001), which must be confirmed by pressing **<SET>** or **<START>**. Now, it is recommended to export the results (see the following possibilities).

4.7.2 Create PDF document

The measuring results saved in the internal memory can be saved to a USB drive as a PDF document.

A recognized USB drive is displayed via a respective symbol (**G**) in the lower status bar.

In order to create the document, press the **<SET>** key.

The file name will be marked with the current time as follows:
("VCplus_JJ_MM_DD_hh-mm.pdf")

i After successfully saving the PDF document, the internal memory (clipboard) is deleted. A later printout of these measuring results from the ViscoClock *plus* will not be possible. However, simultaneous saving and printing is possible (see  **4.7.4**).

If a USB drive is connected to the ViscoClock *plus*, the results are written to a CSV file directly following each measurement: "VCplus.csv". The data can be directly processed further by means of a table calculation program. New measured values are attached to the end of the existing file.

A measurement is only logged in the CSV file, if the ViscoClock *plus* is connected to a USB drive. A later writing from the internal memory to the CSV file is not possible.

4.7.3 Printing measuring results

The measuring results saved in the internal memory can be printed by means of a printer connected via the USB interface (TZ 3863 or other printer compatible with the ViscoClock *plus*).

A recognized printer is displayed via a respective symbol (H) in the lower status bar.

In order to print, press the <SET> key.

i After successfully printing, the internal memory is deleted. You will not be able to create a PDF document with these measuring results at a later time. However, simultaneous saving and printing is possible (see  4.7.4).

4.7.4 Simultaneous printing and creating of a PDF document

The ViscoClock *plus* supports the simultaneous connection of a USB drive and a USB printer (e.g. TZ 3863). The second USB host connection can be created by a USB OTG adapter cable (Mini-B plug on USB A connection).

If both devices were successfully detected and the printing process was started via the <SET> key, the measuring results will be saved as a PDF document and printed at the same time.

4.7.5 Documentation format

The documentation of the measuring results (PDF/printout) has the following format:

No.	Date	Time	SID	VID	Flow Time
1	22.08.16	13:43	01	09	176.54

No.	Consecutive measurement number in the internal memory
Date	Date, display format depends on set format (12/24H)
Time	Time, display format depends on set format (12/24H)
SID	Sample ID = sample number
VID	Visko ID = viscometer number
Flow Time	Measuring time (flow time)

The CSV documentation differs only by the omitted measurement number

Format:	Date;Time;SID;VID;Flow time
Example:	22.08.16;13:43;1;9;176.54

i When opening the CSV file in Microsoft Excel: Excel expects different decimal separators in the standard setting, depending on the system language. Therefore, the ViscoClock *plus* converts the decimal separator depending on the selected time/date format.

Type	Time/date format	Decimal separator
Anglo	12H	Period (.)
Europ.	24H	Comma (,)

If display problems should occur, you can set up your own decimal separator in Excel (2010):

1. File>Options->Advanced.
2. Deactivate the setting "Take separators from operating system".
3. Define the period or the comma as a decimal point (separator) as per the output of the ViscoClock *plus*.

4.7.6 Tips for using the USB interface

The USB drive must be formatted in the FAT16 or FAT32 file system. We recommend using a USB drive. External hard drives without power supplies cannot be used.

During a measurement run, you should not connect or disconnect any USB drives, as the measurement will be terminated in case of an error.

The ViscoClock *plus* supports only the connection of a single USB memory device.

During the connection process (blinking USB icon on the display), the device should not be disconnected.

During the saving process of data, a blinking USB icon on the display signals the access of the USB drive to the ViscoClock *plus*.

4.7.7 Idle mode

The ViscoClock *plus* will automatically switch to an idle (standby) mode after being inactive for 60 minutes, during which the time will be shown on the display. Here, unnecessary components (USB, light barriers, background lights) are switched off and the power consumption is thus reduced.

You can exit this mode by pressing any key and the ViscoClock *plus* will be ready to use again.

If there is no measurement running, the ViscoClock *plus* can be put into standby mode by pressing the **<START>** key early for a long time.

4.8 Notes and error messages

If an error occurs or if the user is notified of a full memory, the ViscoClock *plus* displays an error message with a clear symbol. This is displayed on top of the main screen (4.1).

The displayed error code helps localize the problem by means of the error table (see  6.2).

Use the keys **<SET>** (14) or **<START>** (16) to close the message.

 Severe errors that are not listed and cannot be closed, require a restart by disconnecting the power source.

4.9 Personalizing the header of a PDF document

The header of the PDF documented created by the ViscoClock *plus* (see  4.7.2) can be defined by the user. This way, results can be saved with your company name, for example, in the PDF.

For this, create a text document using a text editor (.txt) with the name "VCplus_header.txt", which contains the text to be displayed (max. 70 characters) and copy this to a USB medium that you are using with your ViscoClock *plus*.

If this file is present on the memory device when creating the PDF, its text will be transferred to the header, otherwise, this line will remain blank.

 When replacing the USB device, make sure that this text is not saved in the ViscoClock *plus*, but is read by the USB drive during each saving session.

The following image shows a cutout of a personalized result printout:

Musterfirma Visco GmbH Mainz; Applikationslabor R405 (Schmidt)					
ViscoClock plus		Serial: 00000231	Firmware: V16.33		
No.	Date	Time	SID	VID	Flow time
1	22.08.16	13:43	00	00	134.75s

Fig. 12 PDF result printout with personalized header

4.10 Master Reset

Use the Master Reset function, all settings and memory slots can be set back to factory values.

For this, press and hold the <↑> and <↓> keys for at least 3 seconds.

A message will be displayed prompting you to perform a restart.

4.11 Software update

The software of the ViscoClock *plus* can be updated by the user via a USB memory device.

Proceed as follows:

1. Copy the latest firmware file (e.g. "VCplus_FW_V_16_35.bin") directly and without a subdirectory to the USB memory device. The file must not be renamed and there must not be any other update file in the same directory!
2. Connect the USB drive with the USB host connection (18) of the switched off ViscoClock *plus*.
3. Hold the keys <↑> & <↓> down simultaneously and connect the ViscoClock *plus* to the power supply.
4. As soon as the update program is started, you can release these keys.
The updater will now search for the matching file on the USB drive.
5. After the message: "Press START key to flash firmware on device", the firmware can be installed on the device by pressing the <START> key (16).
6. After the update is completed, there will be an automatic restart.

5 Maintenance

5.1 General notes

⚠ Using alkaline laboratory cleaners poses a health hazard (chemical burns, injuries to skin and eyes)!

- Use personal protective equipment during the cleaning process, such as: Eye protection, protective gloves, laboratory coat, respiratory protection.

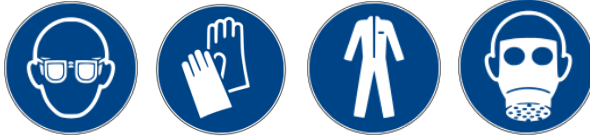

- Please observe the memorandums of the employer's liability insurance associations and the safety data sheets of the manufacturers.

i Cleaners can damage the glass in the viscometer.

5.2 Cleaning

After each use you should clean the stand (3) using a moist cloth and e.g. dishwashing liquid.

Clean the upper (5) and lower (4) measurement level with a fine, dry paintbrush. Transmitter and receiver are located across from each other.

Accurate measurement is only possible with clean measurement planes.

Cleaning the viscometer as per DIN 51 562 part 1.

After that, store the *ViscoClock plus* and the viscometer dry and free of dust for the next measurement!

5.3 Inspection

Check the cable and plug contacts for mechanical damage and corrosion.

5.4 Repair

Send the device to the service (see back side of these manual) or to an authorized dealer.

6 Faults and error messages

6.1 Faults

- The display is dark.

Cause	Remedy
Power supply has been disrupted.	Check connection/function of plug.

- The sample cannot be pushed or suctioned up.

Cause	Remedy
The silicone plug (8) is not properly seated on the filling tube (pushing mode) or capillary tube (suction mode).	Check the silicon stopper for tight seating.
The manual pump is not fully seated on the silicone plug (8).	Set the glass tube from the manual pump tightly on the silicon stopper.
For the suction operating mode and Ubbelohde viscometers: The black silicone cap is not (10) attached to the ventilation tube.	Attach the silicone cap to the ventilation tube.

- The sample rises in the venting tube when pushed up.

Cause	Remedy
Silicone cap (10) is not attached to the ventilation tube of the Ubbelohde viscometer.	Attach the silicone cap (10) to the ventilation tube.
The <START> key (16) was pressed prior to pumping up so that the ventilation valve is open.	Pressing the <START> key again closes the ventilation valve. i The pumping up of the liquid is only possible while the ventilation valve is closed. ⚠ During pressure mode and with the ventilation valve open, liquid can be pushed into the casing of the ViscoClock plus!
Ventilation valve is leaking.	First make sure that the <START> key has not been pressed prior to the pumping process and that the ventilation valve is not open. The ventilation valve may be damaged > contact the Service (see back of these manual) or the dealer.

- **Liquid dripping from ViscoClock *plus*.**

Cause	Remedy
<p>The <START> key (16) was pressed prior to pumping up so that the ventilation valve is open. Sample was pumped into the measuring device ViscoClock plus with the manual pump.</p>	<p>Contact the Service Center (see backside of this manual) or the dealer.</p>

- **The measurement was not started and/or stopped when the meniscus passed through the light barrier.**
- **The timer is not running properly or not running at all.**

Cause	Remedy
<p>The sample liquid is not transparent enough.</p> <p>Malfunction of the timing device</p>	<p>Check the ViscoClock <i>plus</i> with a transparent specimen.</p> <p>Check the functionality of the measurement time recorder.</p> <ul style="list-style-type: none"> - Take the viscometer from the device. - Push down the ventilation membrane rod (release lever). - Press start key. - Use a thin object (e.g. pencil) to enter the upper light barrier > Time measurement should start now. - The time measurement must stop again when the lower light barrier is passed through a thin object (e.g. pencil).

6.2 Error messages

- Error while measuring

Error code	Display message	Errors	Description	Remedy
0x02000201	Timeout at upper LB	Timeout at upper light barrier (A measurement was started; no meniscus passed through the upper light barrier within the timeout period of 120 seconds)	1. Viscometer is not positioned properly. 2. The sample liquid is not transparent enough.	1. Check the position of the viscometer. 2. Sample cannot be measured! Contact the Service Center (see back of
0x02000203	Detection Error	Wrong signal on the lower light barrier (The measurement was started and no meniscus passing was detected on the lower light barrier before one was detected on the upper light barrier)	1. Air bubbles in the sample liquid. 2. Sample was not above the upper light barrier at the time of triggering.	1. Air bubbles in the sample liquid. 2. Pump the sample above the upper light barrier prior to starting the measurement.

- Error while saving the measuring results

Error code	Display message	Errors	Description	Remedy
0x02000301	Low internal memory	Internal data memory almost full	Note: The internal memory has been populated almost entirely with measured values.	Save, print or delete data
0x02000302	Internal memory full	Internal data memory full	All memory slots populated with measured values. New measured values cannot be saved	Save, print or delete data
0x02000311 ...12	CSV R/W Err on USB OTG	Error during writing into CSV file to USB OTG or USB host	The creation or writing of the CSV file at the respective USB interface has failed	Reconnect the USB drive or restart the unit. Format the USB drive if necessary (FAT16/32)

- **Error during setting up of USB drives**

Error code	Display message	Errors	Description	Remedy
0x02000E01	Two USB keys not supported	A max. of 1 USB drive supported	A second USB drive was connected, but only one is supported	Use only one USB medium
0x02000E21 ...24	USB connection failed	Error when installing USB drives to the USB host interface	Internal USB interface error	Reconnect the USB drive or restart the unit. Format the USB drive if necessary (FAT16/32)
0x02000E25 ...27			Error during reading/opening of the CSV file	
0x02000E28 ...E29			Printer has incorrect device ID	Use a compatible printer
0x02000E2A			Printer cannot be initialized	Disconnect the printer, restart and reconnect it
0x02000E2B			The connected device is neither a USB drive nor a printer	Use compatible USB drives
0x02000E11- 0x02000E1B		Error when installing USB drives to the USB OTG interface	Analog to host (0x02000E21 - 0x02000E2B)	See above errors

- **Error during printing and PDF generation**

Error code	Display message	Errors	Description	Remedy
0x02001001	No USB drive connected	No USB drive connected	No USB drive recognized to save as PDF file or printer to print the measuring results	Connect the desired USB drive (memory medium / printer)
0x02001013	No data to print/save	No data in the internal memory	A USB memory medium or a printer is connected, but no measured values are available to output	Perform the measurement to fill the memory with measured values
0x02001011 ...12	Failed to print/ save PDF	Error during creation/saving of the PDF document	The saving, creation or writing of the PDF document to a USB drive has failed	Reconnect the USB drive or restart the unit. Format the USB drive if necessary (FAT16/32)
0x02001014				
0x02001015 ...17			Error while printing	Sending of commands to the printer failed

7 Guarantee

We provide guarantee for the device described for two years from the date of purchase. This guarantee covers manufacturing faults being discovered within the mentioned period of two years. Claim under guarantee covers only the restoration of functionality, not any further claim for damages or financial loss. Improper handling/use or illegitimate opening of the device results in loss of the guarantee rights. The guarantee does not cover wear parts, as lobes, cylinders, valves and pipes including the thread connections and the titration tips. The breach of glass parts is also excluded. To ascertain the guarantee liability, please return the instrument and proof of purchase together with the date of purchase freight paid or prepaid.

8 Storage and transport

If the ViscoClock *plus* is intended to be stored intermediately or transported again, the original packaging will provide the best conditions to protect the devices. However, in many cases, this packaging is no longer available, so that a similar packaging must be created. Sealing of the unit in foil is advantageous here. The devices should be stored in a room with a temperature between + 10 and + 40°C and the (relative) humidity should not exceed 70% (rel.).

9 Recycling and disposal



Please observe the applicable local or national regulations concerning the disposal of "waste electrical and electronic equipment".

The ViscoClock *plus* and his packaging are manufactured as far as possible from materials which can be disposed of environmental-friendly and recycled in a technically appropriate manner. If you have any question regarding disposal, please contact the service (see backside of this manual).

i The main printed board carries a lithium battery. Batteries should not to be disposed of with the normal domestic waste. They will be taken back and recycled or disposed of properly by the manufacturer at no cost.

10 Accessories and Spare Parts

10.1 Accessories

VZ 6550	Manual pump set "push"
VZ 6554	Manual pump set "suction"
TZ 1858	All voltage plug power supply 100 - 240 V ~ 9 V / DC, 550 mA
TZ 1852	Primary adapter for TZ 1858, for UK
TZ 1854	Primary adapter for TZ 1858, for Australia
TZ 3863	Thermal printer
TZ 3864	Printer paper for TZ 3863, very high durability (5 rolls)
VZ 6570	USB OTG adapter cable (mini B plug on USB A socket)
CT 72/...	Transparent thermostats of the CT 72 series (CT 72/P, CT 72/2, CT72/4)

10.2 Spare parts

VZ 6551	Silicone plugs (8), 5 ea.
VZ 6572	Silicone cap (10) for ventilation tube, including connection hose, 1 ea. <u>alternatively:</u> VZ 5101 Silicone cap () for ventilation tube, including connection hose, 1 ea.
VZ 6556	Replacement glass tube (28) for manual pump VZ 6550 or VZ 6554

SI Analytics[®]

**EG - KONFORMITÄTSERKLÄRUNG
EC - DECLARATION OF CONFORMITY
CE - DÉCLARATION DE CONFORMITÉ
CEE - DECLARACIÓN DE CONFORMIDAD**

Wir erklären in alleiniger Verantwortung, dass das folgende Produkt	We declare under our sole responsibility that the following product	Nous déclarons sous notre seule responsabilité que le produit ci-dessous	Declaramos bajo nuestra única responsabilidad, que el producto listado a continuación
Viskositätsmessgerät	Viscosity measuring unit	Appareil de mesure de la viscosité	Equipo medidor de viscosidad
ViscoClock plus			
auf das sich diese Erklärung bezieht, übereinstimmt mit den folgenden EG Richtlinien.	to which this declaration relates are in conformity with the following EC directives.	auxquels se réfère cette déclaration est conforme directives CE soul vantes	todo lo relativo a esta declaración está en conformidad con las directivas CEE siguientes
EMV EG-Richtlinie 2014/30/EU Sicherheit EG Richtlinie 2014/35/EU	EMC EC-Directive 2014/30/EU Safety EC-Directive 2014/35/EU	CEM CE-Directive 2014/30/EU Sécurité CE-Directive 2014/35/EU	CEM CEE siguientes 2014/30/EU Seguridad CEE siguientes 2014/35/EU
Angewandte harmonisierte Normen oder normative Dokumente	Applied harmonized standards or normative documents	Normes harmonisées ou documents normatifs appliqués	Estándares armonizados aplicados o documentos normativos
EMV EN 61326-1:2013 Sicherheit EN 61010-1 :2010	EMC EN 61326-1:2013 Safety EN 61010-1 :2010	CEM EN 61326-1:2013 Sécurité EN 61010-1 :2010	CEM EN 61326-1:2013 Seguridad EN 61010-1 :2010

Mainz den 07.07.2016

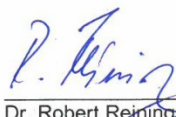
Dr. Robert Reining
 Geschäftsführer, Managing Director

Konf. No.: AVS008

Xylem Analytics Germany GmbH
 Dr.-Karl-Slevogt-Str. 1
 82362 Weilheim
 Deutschland, Germany, Allemagne, Alemania

Bescheinigung des Herstellers

Wir bestätigen, dass oben genanntes Gerät gemäß DIN EN ISO 9001, Absatz 8.2.4 „Überwachung und Messung des Produkts“ geprüft wurde und dass die festgelegten Qualitätsanforderungen an das Produkt erfüllt werden.

Supplier's Certificate

We certify that the above equipment has been tested in accordance with DIN EN ISO 9001, Part 8.2.4 "Monitoring and measurement of product" and that the specified quality requirements for the product have been met.

Certificat du fournisseur

Nous certifions que le produit a été vérifié selon DIN EN ISO 9001, partie 8.2.4 «Surveillance et mesure du produit» et que les exigences spécifiées pour le produit sont respectées.

Certificado del fabricante

Certificamos que el aparato arriba mencionado ha sido controlado de acuerdo con la norma DIN EN ISO 9001, sección 8.2.4 «Seguimiento y medición del producto» y que cumple con los requisitos de calidad fijados para el mismo

SI Analytics

a **xylem** brand

Hersteller

(Manufacturer)

Xylem Analytics Germany GmbH

Dr.-Karl-Slevogt-Str.1
82362 Weilheim
Germany

SI Analytics

Tel. +49(0)6131.66.5111

Fax. +49(0)6131.66.5001

E-Mail: si-analytics@xyleminc.com

www.si-analytics.com

Service und Rücksendungen

(Service and Returns)

Xylem Analytics Germany Sales GmbH & Co.KG

SI Analytics

Gebäude G12, Tor Rheinallee 145
55122 Mainz
Germany

Tel. +49(0)6131.66.5042

Fax. +49(0)6131.66.5105

E-Mail: Service-Instruments.si-analytics@xyleminc.com

SI Analytics is a trademark of Xylem Inc. or one of its subsidiaries.

© 2016 Xylem, Inc. Version 161219 **US 825 295 3**